



BOBCAT (MELROE)

Kit Number	Code (Pg. xiv)	Rod X Bore Size	List Price
BCK-6810717	I-U-10	2 X 2-3/4	\$ 41.29
BCK-6810718	I-U-10	2 X 4	56.96
BCK-6813752	I-U-10	1-3/4 X 2-1/2	24.71
BCK-6815085	I-U-10	1-3/4 X 3-1/4	30.33
BCK-6815959	I-U-10	2 X 3-3/4	86.03
BCK-6816352	I-U-10	1-3/4 X 3	28.41
BCK-6816533	I-U-10	1-3/4 X 3-1/4	31.71
BCK-6816534	I-U-10	1-1/2 X 2-3/8	21.19
BCK-6816535	I-U-10	1-1/2 X 2-1/4	21.91
BCK-6816536	I-U-10	1-5/8 X 3	27.33
BCK-6816537	I-U-10	1-1/2 X 2-1/2	27.42
BCK-6817081	I-U-10	2-1/4 X 3-1/2	66.08
BCK-6817143	I-U-10	2 X 3-1/4	41.50
BCK-6817183	I-U-10	2-1/4 X 4	78.58
BCK-6818161	I-U-10	2 X 3-1/4	34.57
BCK-7135547	I-U-10	1-1/2 X 3	27.41
BCK-7135551	I-U-10	1-1/2 X 3-1/4	27.28
BCK-7135555	I-U-10	1-1/2 X 3-1/2	29.90
BCK-7135557	I-U-10	1-1/2 X 2-1/4	27.62
BCK-7135558	I-U-10	1-1/2 X 2-1/4	26.52
BCK-7135559	I-U-10	1-1/2 X 2-1/2	27.42
BCK-7137770	I-U-10	1-1/4 X 2	23.92
BCK-7137771	I-U-10	1 X 2	10.22
BCK-7137772	I-U-10	1 X 2	15.37
BCK-7137865	I-U-10	1-3/4 X 2-1/2	19.68
BCK-7137935	I-U-10	1-3/4 X 2-3/4	23.67
BCK-7137939	I-U-10	1-5/8 X 3	27.33
BCK-7137966	I-U-10	2 X 3-1/4	29.76
BCK-7156581	I-U-10	1-3/4 X 3-1/4	30.33
BCK-7162060	I-U-10	1-3/4 X 3-1/4	30.33
BCK-7162061	I-U-10	1-3/4 X 3	37.80
BCK-7162062	I-U-10	1-1/2 X 2-3/4	36.50
BCK-749049	I-OB-3	1-1/2 X 2	9.86
BCK-M610	P-O-2	1-1/8 X 1-7/8	3.88

CAMECO

Kit Number	Cylinder	Code (Pg. xiv)	Rod X Bore Size	List Price
CAM-017-1344693		N-N-14	100mm Piston Kit	\$ 21.54
CAM-017-1344694		P-UB-1	50mm Rod Kit	43.83
CAM-061-0007820		P-U-3	1-1/2 X 3-1/2	14.13
CAM-061-0021481		I-U-4	2-1/2 X 5	190.92
CAM-061-0297978		P-U-10	2-1/4 X 3	41.15
CAM-061-05021	001-05007	P-U-5	1-1/4 X 3	69.13
CAM-061-05835		P-U-3	1-1/4 X 2-1/2	12.83
CAM-061-06067	001-06063	P-OB-3	1-1/16 X 2-1/2	9.86
CAM-061-07221		I-V-5	2-1/2 X 7	123.77
CAM-061-08458	001-08459	I-U-5	2-1/2 X 4	72.67
CAM-061-08913		I-U-5	2-1/2 X 5	65.26
CAM-061-09619		P-U-3	2 X 4	26.18
CAM-061-1247081		P-U-1	3 Rod Kit	32.26
CAM-061-1304751		I-U-10	1-1/4 X 2-1/2	17.32
CAM-061-1309627		P-U-10	4 X 7	238.95

CAMECO

Kit Number	Cylinder	Code (Pg. xiv)	Rod X Bore Size	List Price
CAM-061-1347081		P-U-1	3 Rod Kit	\$ 32.26
CAM-061-1362725		I-U-10	1 X 2	11.88
CAM-061-21693		I-U-9	2-1/2 X 4	64.20
CAM-061-21699	001-21359	I-U-9	1-1/4 X 3	64.01
CAM-061-50139		P-V-3	1-1/4 X 3	25.11
CAM-061-53511		P-UB-10	2-1/2 X 4	52.96
CAM-061-53967	001-37224		1-1/4 Rod Kit	28.99
CAM-061-53968		P-U-1	1-1/2 Rod Kit	24.46
CAM-061-53970	001-89599		2-1/2 Rod Kit	30.24
CAM-061-53972	001-89576		3" Piston Kit	28.24
CAM-061-53973	001-89599		4" Piston Kit	31.65
CAM-061-53974		N-N-10	5" Bore	144.71
CAM-062-05672			Valve Kit	3.29
CAM-062-22730			Motor Kit	10.32

CASCADE

Kit Number	Code (Pg. xiv)	Rod X Bore Size	List Price
CAS-552715	I-U-1	2-1/4 X 2-3/4	\$ 36.41
CAS-554289	MULTI STAGE	4, 5	124.57
CAS-560349	I-U-4	2" X 75 mm	78.64
CAS-562591	I-U-4	2" X 60 mm	62.85
CAS-615939	O-RING KIT		5.54
CAS-615940	O-RING KIT		7.31
CAS-628080	I-V-8	1-1/4 X 3	48.89
CAS-630033	I-U-3	1-1/2 X 4-3/4	24.95
CAS-630038	I-U-3	1-1/2 X 4-3/4	23.12
CAS-630445	I-V-8	1-1/4 X 2-1/2	42.91
CAS-631277	P-V-9	2 X 4-3/4	147.89
CAS-638884	MULTI STAGE	2-3/4, 3-3/4	77.91
CAS-639695	I-U-4	3/4 X 1-3/4	38.60
CAS-640371	I-O-4	4 X 4-1/2	64.70
CAS-641956	MULTI STAGE	4, 5	106.25
CAS-643280	I-U-4	3 X 3-1/2	40.68
CAS-644690	I-U-5	1-3/4 X 4	77.21
CAS-646305	I-U-3	3-1/2 X 4	49.89
CAS-646339	SWIVEL KIT		4.99
CAS-647626	I-U-4	1 X 2-1/4	20.31
CAS-647892	I-V-8	1-3/4 X 4.520	57.52
CAS-650018	I-U-5	3-1/2 X 7	89.64
CAS-651847	I-N-4	2 X 2-1/2	30.53
CAS-654519	P-V-1	2 X 4-3/4	39.20
CAS-656167	MULTI STAGE	4-1/4, 5-7/16	149.00
CAS-658717	MULTI STAGE	2-3/4, 3-3/4	73.42
CAS-660954	I-U-4	1-5/8 X 3-1/2	43.45
CAS-660955	I-U-4	3 X 4	51.22
CAS-664814	N-U-4	3/4 X 1-3/4	21.14
CAS-667622	MULTI STAGE	2-1/2, 3-1/4, 4-1/2	142.58

45C VIEWMAST II

CAS-T555286	P-U-10	2-1/8 X 3	\$ 60.97
-------------	--------	-----------	----------

REPLACEMENT SEAL KITS FOR CASE EQUIPMENT*

Replacement Seal Kits By Machine Type

Table of Contents

Machine Type		Page
Excavators	880, 880B, 880C, 880D, 880R, 9010B, 9020B, 9030B, 9040B	144
Skid Steer Loaders	95XT, 1818, 1825, 1835, 1835B, 1835C, 1838, 1840, 1845, 1845S, 1845B, 1845C	144 - 146
Track-Type Dozers/Loaders	310E, 310F with Backhoe Model 31, 310G with Backhoe Models 26, 26B, 26S, 32, 33, 350 with Backhoe Models 26, 26B, 26C, 26S, 350B with Backhoe Models 26C, 26D, 420C, 450 with Backhoe Models 26, 26B, 26C, 26S, 32, 33, 35, 450B, 450C, 455B, 455C with Backhoe Models 26D, 35, 475 Cable Layer, 550E, 550G, 650G, 750 with Backhoe Models 32, 33S, 34, 750H, 850 with Backhoe Models 34, 35, 36, 850B with Backhoe Model 35, 850C, 855C with Backhoe Models 35A, 35C WL, 3, 850D with Backhoe Models 35C, 35C WL, 850E, 855E, 850G, 1150 with Backhoe Models 32, 34, 36, 1150B, 1150C, 1150D, 1155D, 1150G, 1450, 1450B, 1455B	146 - 160
Uni-Loaders	1530B, 1700, 1816B, 1816C, 1818, 1825, 1830, 1835, 1835B, 1840, 1845, 1845B, 1845C, 1845S	160 - 161
Unimogs	MB4/94 with Model 26C Backhoe, P80 Cable Plow, T70	161 - 162
Wheel Loaders 21-Series	621, 621B, 621C, 721, 721B, 721C, 821, 821B, 821C, 921, 921C	162 - 163
Wheel Loaders W-Series	W3, W7, W7C, W7E, W8E, W9, W9A, W9B, W9C, W9E, W10, W10B, W10C, W10E, W11, W11B, W14, W14L, W14H, W14B, W18, W20, W20B, W18B, W20C, W24, W24B, W24C, W26B, W26FL, W30, W36	163 - 167
Wheeled Backhoe Loaders	380LL, 430 with Backhoe Models 21, 22, 23, 480, 480B with Backhoe Models 23, 26, 26B, 26S, 480C, 480D, 480D LL, 480E, 480E LL, 480F, 480F LL, 530 with Backhoe Models 31, 32, 32S, 580 with Backhoe Models 33, 33S, 580B with Backhoe Model 35, 580C, 580D, 580 Super D, 580 Super E, 580F, 580K, 580 Super K, 580L, 580 Super L Construction King, 580 Super L, 580 Super L, 580M, 590 Super L, 590 Super M, 590, 680, 680B, 680C, 680CK, 680E, 680G, 680H, 680K, 680L, 780, 780B	167 - 181
Alpha-Numeric Kit Listing		182 - 185
Case Individual Parts		186 - 188

All manufacturer's names, part numbers and descriptions are used for reference purposes only. We do not imply that any part shown is the product of these manufacturers. We also do not imply that the list price shown is exactly that of the manufacturer.



CASE

Replacement Kits For

Excavators								
APPLICATION	CYL #	Piston	SERIAL #	CODE	ROD	BORE	KIT #	List \$
MODEL 880								
ARM		2pc	6200000-6201114	P-UB-9	2-1/2	5-1/2	JIC-G105514	55.50
		2pc	6201115-UP	P-UB-9	2-3/4	5-1/2	JIC-G105566	89.58
BOOM		2pc	6200000-6201114	P-UB-9	2-1/2	5-1/2	JIC-G105514	55.50
		2pc	6201115-UP	P-UB-9	2-3/4	5-1/2	JIC-G105566	89.58
BUCKET		2pc		P-UB-9	2-1/2	5	JIC-G105515	52.56
EXT BUCKET		2pc		P-UB-9	3	5	JIC-G105531	60.15
EXT DIPPER		2pc		P-UB-9	2-1/2	4	JIC-G34636	44.02
		1pc		P-UB-10	2-1/4	4	JIC-G105556	43.45
MODEL 880B, 880C, 880D								
ARM		2pc		P-UB-9	2-3/4	5-1/2	JIC-G105566	89.58
BOOM		2pc		P-UB-9	2-3/4	5-1/2	JIC-G105566	89.58
BUCKET		2pc		P-UB-9	2-1/2	5	JIC-G109499	69.28
MODEL 880R								
ARM		2pc		P-UB-9	2-3/4	5-1/2	JIC-G105566	89.58
BOOM		2pc		P-UB-9	2-3/4	5-1/2	JIC-G105566	89.58
EXT BUCKET		2pc		P-UB-9	3	5	JIC-G105531	60.15
EXT DIPPER		2pc	-->5352380	P-UB-9	2-1/2	4	JIC-G34636	44.02
		1pc	5352381-UP	P-UB-10	2-1/4	4	JIC-G105556	43.45
MODEL 9010B								
ARM		1pc		P-UB-10	80 mm	115 mm	JIC-164494A1	239.37
BOOM		1pc		P-UB-10	75 mm	100 mm	JIC-164493A1	149.65
BUCKET		1pc		P-UB-10	70 mm	95 mm	JIC-162976A1	209.39
MODEL 9020B								
ARM		1pc		P-UB-10	90 mm	125 mm	JIC-161913A1	271.31
BOOM		1pc		P-UB-10	80 mm	115 mm	JIC-161912A1	227.16
BUCKET		1pc		P-UB-10	75 mm	105 mm	JIC-161914A1	238.49
MODEL 9030B								
ARM (Long Reach)		1pc		P-UB-10	105 mm	150 mm	JIC-160227A1	320.33
ARM (w/o long reach)		1pc		P-UB-10	100 mm	135 mm	JIC-160579A1	307.62
BOOM (w/ load option)		1pc		P-UB-10	85 mm	125 mm	JIC-164183A1	214.61
BOOM (w/o load option)		1pc		P-UB-10	85 mm	125 mm	JIC-160577A1	217.29
BUCKET (Long Reach)		1pc		P-UB-10	70 mm	95 mm	JIC-162976A1	209.39
BUCKET (w/o long reach)		1pc		P-UB-10	80 mm	120 mm	JIC-160581A1	200.29
MODEL 9040B								
ARM	151155A1			P-UB-10	110 mm	160 mm	JIC-156002A1	395.90
	159453A1			P-UB-10	105 mm	150 mm	JIC-160227A1	320.33
	162816			P-UB-10	105 mm	150 mm	JIC-160227A1	320.33
BOOM	159462A1			P-UB-10	90 mm	130 mm	JIC-LZ00533	251.44
	159463A1			P-UB-10	90 mm	130 mm	JIC-LZ00533	251.44
	162815A1			P-UB-10	90 mm	130 mm	JIC-LZ00533	251.44
BUCKET	159452A1			P-UB-10	90 mm	135 mm	JIC-160229A1	241.27
	160752A1			P-UB-10	70 mm	95 mm	JIC-LZ00522	209.39
Skid Steer Loaders								
APPLICATION	CYL #	Piston	SERIAL #	CODE	ROD	BORE	KIT #	List \$
MODEL 95XT								
BACKHOE BOOM	1346450C2	1pc		P-UB-10	1-1/2	3	JIC-1543256C1	34.04



CASE

Replacement Kits For

Skid Steer Loaders								
APPLICATION	CYL #	Piston	SERIAL #	CODE	ROD	BORE	KIT #	List \$
MODEL 95XT								
BACKHOE BUCKET	1346397C2	1pc		P-UB-10	1-1/2	2-3/4	JIC-1346409C2	56.25
BACKHOE DIPPER	1346411C2	1pc		P-UB-10	1-1/2	3	JIC-1543256C1	34.04
BACKHOE SWING	H673149			P-OB-1	2-3/4		JIC-H53041	18.70
LOADER LIFT	139091A3	1pc		P-UB-10,12	1-3/4	2-1/2	JIC-198376A2	42.91
STABILIZER (Fold Down)	101643A1	1pc		P-U-10	1-3/8	3	JIC-700710260	66.06
STABILIZER (Vertical)	H514117	1pc		P-U-10	1	2	JIC-H52704	13.77
TRENCHER BOOM LIFT	221700A1	1pc		P-U-10	1-3/4	3-1/2	JIC-235933A1	26.65
MODEL 1818								
BUCKET TILT	D136128	1pc		P-U-10	1	2	JIC-N14638	29.07
LOADER BUCKET	104517A1	1pc		P-U-10	1	2	JIC-110510A1	44.91
LOADER LIFT	104516A1	1pc		P-U-10	1-3/8	2	JIC-110507A1	44.91
	D136838	1pc		P-U-10	1-1/4	2	JIC-N14639	35.66
MODEL 1825								
BUCKET TILT	D136128	1pc		P-U-10	1	2	JIC-N14638	29.07
LOADER BUCKET	104517A1	1pc		P-U-10	1	2	JIC-110510A1	44.91
LOADER LIFT	104516A1	1pc		P-U-10	1-3/8	2	JIC-110507A1	44.91
	D136838	1pc		P-U-10	1-1/4	2	JIC-N14639	35.66
MODEL 1835								
GRAPPLE	D61075	1pc		P-U-10	1	2	JIC-D61006	6.61
LOADER BUCKET		1pc		P-UB-10	1-1/4	2-1/2	JIC-G109476	27.34
	G103407	1pc		P-U-10	1-1/4	2-1/8	JIC-G105507	22.57
LOADER LIFT		1pc		P-UB-10	1-1/2	2-1/2	JIC-G109458	20.07
	G34864	1pc		P-U-10	1-1/4	2-1/8	JIC-G34819	20.25
MODEL 1835B								
GRAPPLE	D61075	1pc		P-U-10	1	2	JIC-D61006	6.61
LOADER BUCKET	G103407	1pc		P-UB-10	1-1/4	2-1/2	JIC-G109476	27.34
LOADER LIFT		1pc		P-UB-10	1-1/2	2-1/2	JIC-G109458	20.07
	G106818	1pc		P-UB-10	1-1/2	2-1/2	JIC-128725A1	24.36
MODEL 1835C								
BUCKET TILT	118110A1	1pc	JAF0130838-UP	P-U-10	1-1/4	2-1/2	JIC-128728A1	20.62
	G103407	1pc	-->JAF0130838	P-U-10	1-1/4	2-1/2	JIC-128728A1	20.62
GRAPPLE	D61075	1pc		P-U-10	1	2	JIC-D61006	6.61
LIFT		1pc		P-U-10	1-1/4	2-1/8	JIC-G34819	20.25
	117824A1	1pc	JAF0130838-UP	P-UB-10	1-1/2	2-1/2	JIC-128725A1	24.36
	G110666	1pc	-->JAF0130838	P-UB-10	1-1/2	2-1/2	JIC-128725A1	24.36
MODEL 1838								
BACKHOE BOOM, DIPPER, & BUCKET	G100936	1pc		P-UB-10	1-1/2	3	JIC-1543252C1	36.15
BACKHOE DIPPER	G109376	1pc		P-UB-10	1-1/2	3	JIC-1543313C1	42.91
BACKHOE SWING	H514125			P-OB-1	2-3/4		JIC-H53041	18.70
GRAPPLE	D61010	1pc		P-U-10	1	2	JIC-D61006	6.61
LOADER BUCKET TILT	118110A1	1pc		P-U-10	1-1/4	2-1/2	JIC-128728A1	20.62
LOADER LIFT	117824A1	1pc		P-UB-10	1-1/2	2-1/2	JIC-128725A1	24.36
STABILIZER (Fold Down)	101643A1	1pc		P-U-10	1-3/8	3	JIC-700710260	66.06
STABILIZER (Vertical)	H514117	1pc		P-U-10	1	2	JIC-H52704	13.77

CASE



CASE

Replacement Kits For

Skid Steer Loaders								
APPLICATION	CYL #	Piston	SERIAL #	CODE	ROD	BORE	KIT #	List \$
MODEL 1840								
BACKHOE BOOM	1346450C2	1pc		P-UB-10	1-1/2	3	JIC-1543256C1	34.04
BACKHOE BUCKET	1346397C2	1pc		P-UB-10	1-1/2	2-3/4	JIC-1346409C2	56.25
BACKHOE DIPPER	1346411C1	1pc		P-UB-10	1-1/2	3	JIC-1543256C1	34.04
BACKHOE SWING	H673149			P-OB-1	2-3/4		JIC-H53041	18.70
GRAPPLE	D61075	1pc		P-U-10	1	2	JIC-D61006	6.61
LOADER BUCKET TILT	118110A1	1pc		P-U-10	1-1/4	2-1/2	JIC-128728A1	20.62
	G103407	1pc		P-U-10	1-1/4	2-1/2	JIC-128728A1	20.62
LOADER LIFT	117824A1	1pc		P-UB-10	1-1/2	2-1/2	JIC-128725A1	24.36
	G110666	1pc		P-UB-10	1-1/2	2-1/2	JIC-128725A1	24.36
STABILIZER (Vertical)	H514117	1pc		P-U-10	1	2	JIC-H52704	13.77
MODEL 1845, 1845S								
4-IN-1 BUCKET	G33748	1pc		P-UB-10	1-1/2	3	JIC-1543313C1	42.91
BUCKET DUMP	G34926	1pc		P-U-10	1-1/4	2-1/8	JIC-G105507	22.57
LOADER LIFT - 1845	G37917	1pc		P-UB-10	1-1/2	2-1/2	JIC-128725A1	24.36
LOADER LIFT - 1845S	G100295	1pc		P-UB-10	1-1/2	2-1/2	JIC-128725A1	24.36
SCARIFIER	G33744	1pc		P-UB-10	1-1/2	3	JIC-1543313C1	42.91
MODEL 1845B								
LOADER BUCKET	G34926	1pc		P-UB-10	1-1/4	2-1/2	JIC-G109476	27.34
LOADER CLAM	G33748	1pc		P-UB-10	1-1/2	3	JIC-1543313C1	42.91
LOADER LIFT	G100295	1pc		P-UB-10	1-1/2	2-1/2	JIC-128725A1	24.36
SCARIFIER	G33744	1pc		P-UB-10	1-1/2	3	JIC-1543313C1	42.91
MODEL 1845C								
BACKHOE BOOM	1346450C2	1pc		P-UB-10	1-1/2	3	JIC-1543256C1	34.04
BACKHOE BUCKET	1346397C2	1pc		P-UB-10	1-1/2	2-3/4	JIC-1346409C2	56.25
BACKHOE DIPPER	1346411C1	1pc		P-UB-10	1-1/2	3	JIC-1543256C1	34.04
	G109376	1pc		P-UB-10	1-1/2	3	JIC-1543313C1	42.91
BACKHOE SWING	H673149			P-OB-1	2-3/4		JIC-H53041	18.70
BOOM, DIPPER, & BUCKET	G100936	1pc		P-UB-10	1-1/2	3	JIC-1543252C1	36.15
LOADER BUCKET	G34926	1pc		P-U-10	1-1/4	2-1/2	JIC-128728A1	20.62
LOADER LIFT	117903A1	1pc		P-UB-10	1-1/2	2-1/2	JIC-128725A1	24.36
	129011A1	1pc		P-UB-10	1-1/2	2-1/2	JIC-128725A1	24.36
	G109773	1pc		P-UB-10	1-1/2	2-1/2	JIC-128725A1	24.36
	G109777	1pc		P-UB-10	1-1/2	2-1/2	JIC-128725A1	24.36
STABILIZER	101643A1	1pc		P-U-10	1-3/8	3	JIC-700710260	66.06
	H514117	1pc		P-U-10	1	2	JIC-H52704	13.77
	H672226	1pc		P-U-10	1-3/8	3	JIC-700710260	66.06
SWING	H514125			P-OB-1	2-3/4		JIC-H53041	18.70
Track-Type Dozers/Loaders								
APPLICATION	CYL #	Piston	SERIAL #	CODE	ROD	BORE	KIT #	List \$
MODEL 310E, 310F with Backhoe Model 31								
BACKHOE BOOM		2pc		P-U-9	2	4	JIC-G32616	35.21
				I-U-1	2		JIC-D42876	14.20
		2pc		N-N-9		4	JIC-G33239	17.54
BACKHOE BUCKET		2pc		P-U-9	1-3/4	3-1/2	JIC-G105518	38.14



CASE

Replacement Kits For

Track-Type Dozers/Loaders								
APPLICATION	CYL #	Piston	SERIAL #	CODE	ROD	BORE	KIT #	List \$
MODEL 310E, 310F with Backhoe Model 31								
BACKHOE BUCKET				P-U-1	1-3/4		JIC-D42873	17.99
BACKHOE DIPPER				I-U-1	2		JIC-D42876	14.20
		2pc		P-UB-9	2	4	JIC-G105526	40.35
		2pc		N-N-9		4	JIC-G33239	17.54
BACKHOE STABILIZER		2pc		N-N-9		3-1/2	JIC-G33237	16.09
				P-U-1	1-3/4		JIC-D42873	17.99
BACKHOE SWING		2pc		N-N-9		4	JIC-G33239	17.54
			2019001-3023000	P-U-1	1-3/4		JIC-D42875	13.93
DOZER ANGLING				P-U-1	1-3/4		JIC-D42873	17.99
		2pc		N-N-9		3-1/2	JIC-G33237	16.09
DOZER LIFT				P-U-1	1-1/4		JIC-D42867	14.05
		2pc		N-N-9		2-1/2	JIC-G33193	14.17
DOZER TILT				P-U-1	1-1/4		JIC-D42867	14.05
		2pc		N-N-9		2-1/2	JIC-G33193	14.17
LOADER LIFT				P-U-1	1-3/4		JIC-D42873	17.99
		2pc		N-N-9		3-1/2	JIC-G33237	16.09
LOADER TILT				P-U-1	1-1/4		JIC-D42867	14.05
		2pc		N-N-9		2-1/2	JIC-G33193	14.17
SCARIFIER		2pc		N-N-9		3	JIC-G33151	14.53
				P-U-1	1-1/2		JIC-D42870	17.52
MODEL 310G with Backhoe Models 26, 26B, 26S, 32, 33								
BACKHOE BOOM		2pc	3023001.3032324	N-N-9		3-1/2	JIC-G33237	16.09
		2pc	3023001.3032325	P-UB-9	1-3/4	3-1/2	JIC-G105529	35.77
		2pc	3023001.3032332	N-N-9		4-1/2	JIC-DTVS4.5P	34.76
		2pc	3023001.3032328	N-N-9		4	JIC-G33239	17.54
			3023001.3032323	P-U-1	1-3/4		JIC-D42873	17.99
		2pc	3023001.3032330	P-UB-9	2	4	JIC-G105517	38.79
		2pc	3023001.3032329	P-U-9	2	4	JIC-G32299	38.14
		2pc	3023001.3032333	P-UB-9	2-1/4	4-1/2	JIC-G105520	62.28
			3023001.3032331	P-U-1	2-1/4		JIC-D42878	15.98
		2pc	3023001.3032326	P-UB-9	2-1/2	4	JIC-G34636	44.02
			3023001.3032327	I-U-1	2		JIC-D42876	14.20
BACKHOE BUCKET		2pc	3023001.3032335	N-N-9		3-1/2	JIC-G33237	16.09
		2pc	3023001.3032340	N-N-9		3-1/2	JIC-G33237	16.09
			3023001.3032339	I-U-1	2		JIC-D42874	11.82
			3023001.3032334	P-U-1	1-3/4		JIC-D42872	13.12
		2pc	3023001.3032341	P-U-9	2	3-1/2	JIC-G32293	34.48
		2pc	3023001.3032342	P-UB-9	2	3-1/2	JIC-G105527	42.05
		2pc	3023001.3032338	N-N-9		3-1/2	JIC-G33237	16.09
		2pc	3023001.3032336	P-UB-9	1-3/4	3	JIC-G105524	42.23
			3023001.3032337	P-U-1	1-3/4		JIC-D42873	17.99
BACKHOE DIPPER		2pc	3023001.3032349	P-U-9	2	4	JIC-G32299	38.14
			3023001.3032347	I-U-1	2		JIC-D42876	14.20
		2pc	3023001.3032344	N-N-9		3-1/2	JIC-G33237	16.09
		2pc	3023001.3032351	P-UB-9	1-1/2	3	JIC-G105512	38.33
			3023001.3032343	I-U-1	2		JIC-D42874	11.82

CASE



CASE

Replacement Kits For

Track-Type Dozers/Loaders								
APPLICATION	CYL #	Piston	SERIAL #	CODE	ROD	BORE	KIT #	List \$
MODEL 310G with Backhoe Models 26, 26B, 26S, 32, 33								
BACKHOE DIPPER		2pc	3023001.3032346	P-UB-9	2	3-1/2	JIC-G105527	42.05
		2pc	3023001.3032345	P-U-9	2	3-1/2	JIC-G32293	34.48
		2pc	3023001.3032348	N-N-9		4	JIC-G33239	17.54
		2pc	3023001.3032350	P-UB-9	2	4	JIC-G105517	38.79
BACKHOE STABILIZER			3023001.3032308	P-U-1	1-1/2		JIC-D42870	17.52
		2pc	3023001.3032309	N-N-9		3	JIC-G33151	14.53
		2pc	3023001.3032316	P-U-9	1-3/4	3-1/2	JIC-G105518	38.14
			3023001.3032310	P-U-1	1-3/4		JIC-D42872	13.12
		2pc	3023001.3032315	P-UB-9	1-3/4	3-1/2	JIC-G105529	35.77
			3023001.3032313	P-U-1	1-3/4		JIC-D42873	17.99
		2pc	3023001.3032311	N-N-9		3	JIC-G33151	14.53
		2pc	3023001.3032312	P-UB-9	1-3/4	3	JIC-G105524	42.23
		2pc	3023001.3032314	N-N-9		3-1/2	JIC-G33237	16.09
	BACKHOE SWING		2pc	3023001.3032322	N-N-9		4	JIC-G33239
		2pc	3023001.3032320	P-UB-9	1-3/4	4	JIC-G105519	36.58
			3023001.3032321	P-U-1	1-3/4		JIC-D42875	13.93
		2pc	3023001.3032318	N-N-9		3-1/2	JIC-G33237	16.09
		2pc	3023001.3032319	P-U-9	1-1/2	3-1/2	JIC-G34652	33.57
			3023001.3032317	P-U-1	1-1/2		JIC-D47896	14.14
DOZER ANGLING		2pc	3023001.3032304	P-UB-9	1-1/2	3	JIC-G105512	38.33
			3023001.3032302	P-U-1	1-1/2		JIC-D42870	17.52
		2pc	3023001.3032301	N-N-9		3-1/2	JIC-G33237	16.09
		2pc	3023001.3032301	P-U-9	1-3/4	3-1/2	JIC-G34622	38.14
			3023001.3032301	P-U-1	1-3/4		JIC-D42873	17.99
		2pc	3023001.3032303	N-N-9		3	JIC-G33151	14.53
DOZER LIFT		2pc	3023001.3032301	N-N-9		2-1/2	JIC-G33193	14.17
		2pc	3023001.3032301	P-U-9	1-1/4	2-1/2	JIC-G32295	31.87
			3023001.3032301	P-U-1	1-1/4		JIC-D42867	14.05
DOZER TILT			3023001.3032301	P-U-1	1-1/4		JIC-D42867	14.05
		2pc	3023001.3032301	N-N-9		2-1/2	JIC-G33193	14.17
		2pc	3023001.3032301	P-U-9	1-1/4	2-1/2	JIC-G32295	31.87
EXTENSION		2pc	3023001.3032354	P-UB-9	1-3/4	3-1/2	JIC-G105529	35.77
		2pc	3023001.3032353	N-N-9		3-1/2	JIC-G33237	16.09
			3023001.3032352	P-U-1	1-3/4		JIC-D42873	17.99
LOADER CLAM	G32460	2pc	3023001.3032301	P-UB-9	1-3/4	3	JIC-G105524	42.23
LOADER GRAPPLE		2pc	3023001.3032301	N-N-9		2-1/2	JIC-G33193	14.17
		2pc	3023001.3032301	P-U-9	1-1/2	2-1/2	JIC-G32294	26.40
			3023001.3032301	P-U-1	1-1/2		JIC-D42869	17.66
LOADER HYDRA-LEVELING	D33123	2pc	3023001.3032301	N-N-9		2-1/2	JIC-G33193	14.17
	D33123	2pc	3023001.3032301	P-U-1	1-1/2		JIC-D42869	17.66
	D33123	2pc	3023001.3032301	P-U-9	1-1/2	2-1/2	JIC-G32294	26.40
LOADER LIFT		2pc	3023001.3032301	P-UB-9	1-3/4	3	JIC-G105524	42.23
	D33121, D33122	2pc	3023001.3032301	N-N-9		3	JIC-G33151	14.53
	D33121,		3023001.3032301	P-U-1	1-3/4		JIC-D42872	13.12



CASE

Replacement Kits For

Track-Type Dozers/Loaders								
APPLICATION	CYL #	Piston	SERIAL #	CODE	ROD	BORE	KIT #	List \$
MODEL 310G with Backhoe Models 26, 26B, 26S, 32, 33								
LOADER TILT		2pc	3023001.3032301	N-N-9		2-1/2	JIC-G33193	14.17
	D33113, D33114	2pc	3023001.3032301	P-U-9	1-1/2	2-1/2	JIC-G32294	26.40
	D33113, D33114		3023001.3032301	P-U-1	1-1/2		JIC-D42869	17.66
RIPPER		2pc	3023001.3032306	N-N-9		3	JIC-G33151	14.53
		2pc	3023001.3032307	P-UB-9	1-1/2	3	JIC-G105512	38.33
			3023001.3032305	P-U-1	1-1/2		JIC-D42870	17.52
MODEL 350 with Backhoe Models 26, 26B, 26C, 26S								
BACKHOE BOOM		2pc		P-UB-9	2-1/2	4	JIC-G34636	44.02
		1pc		P-UB-10	2-1/4	4	JIC-G105556	43.45
				P-U-1	1-3/4		JIC-D42873	17.99
		2pc		N-N-9		3-1/2	JIC-G33237	16.09
		2pc		P-UB-9	1-3/4	3-1/2	JIC-G105529	35.77
BACKHOE BUCKET		2pc		P-UB-9	1-3/4	3	JIC-G105524	42.23
				P-U-1	1-3/4		JIC-D42872	13.12
		2pc		N-N-9		3-1/2	JIC-G33237	16.09
		1pc		P-UB-10	1-3/4	3	JIC-G105549	42.54
BACKHOE DIPPER		2pc		P-UB-9	2	3-1/2	JIC-G105527	42.05
		1pc		P-UB-10	2	3-1/2	JIC-G105546	37.63
		2pc		N-N-9		3-1/2	JIC-G33237	16.09
		2pc		P-U-9	2	3-1/2	JIC-G32293	34.48
				I-U-1	2		JIC-D42874	11.82
BACKHOE DIPPER EXT		2pc		P-UB-9	1-1/2	3	JIC-G105512	38.33
		1pc		P-UB-10	1-1/2	3	JIC-G105548	33.43
BACKHOE STABILIZER		2pc		P-U-9	1-3/4	3-1/2	JIC-G105518	38.14
		2pc		P-UB-9	1-3/4	3	JIC-G105524	42.23
		2pc		N-N-9		3	JIC-G33151	14.53
		2pc		P-UB-9	1-3/4	3-1/2	JIC-G105529	35.77
		2pc		N-N-9		3	JIC-G33151	14.53
				P-U-1	1-3/4		JIC-D42872	13.12
				P-U-1	1-1/2		JIC-D42870	17.52
BACKHOE SWING		2pc		P-UB-9	1-3/4	4	JIC-G105519	36.58
		2pc		P-U-9	1-1/2	3-1/2	JIC-G34652	33.57
				P-U-1	1-1/2		JIC-D47896	14.14
		2pc		N-N-9		3-1/2	JIC-G33237	16.09
		1pc		P-UB-10	1-1/2	3-1/2	JIC-G105555	31.46
DOZER ANGLE		2pc		P-U-9	1-3/4	3-1/2	JIC-G105518	38.14
		2pc		N-N-9		3-1/2	JIC-G33237	16.09
				P-U-1	1-3/4		JIC-D42873	17.99
DOZER ANGLE (Angle Tilt Dozer)		1pc		P-UB-10	1-1/2	3	JIC-G105548	33.43
				P-U-1	1-1/2		JIC-D42870	17.52
		2pc		N-N-9		3	JIC-G33151	14.53
		2pc		P-UB-9	1-1/2	3	JIC-G105512	38.33
DOZER LIFT				P-U-1	1-1/4		JIC-D42867	14.05
		2pc		N-N-9		2-1/2	JIC-G33193	14.17

CASE



CASE

Replacement Kits For

Track-Type Dozers/Loaders								
APPLICATION	CYL #	Piston	SERIAL #	CODE	ROD	BORE	KIT #	List \$
MODEL 350 with Backhoe Models 26, 26B, 26C, 26S								
DOZER LIFT		2pc		P-U-9	1-1/4	2-1/2	JIC-G32295	31.87
		1pc		P-UB-10	1-1/4	2-1/2	JIC-G105551	28.43
DOZER TILT				P-U-1	1-1/4		JIC-D42867	14.05
		1pc		P-UB-10	1-1/4	2-1/2	JIC-G105551	28.43
		2pc		N-N-9		2-1/2	JIC-G33193	14.17
		2pc		P-U-9	1-1/4	2-1/2	JIC-G32295	31.87
LOADER CLAM		2pc		P-UB-9	1-3/4	3	JIC-G105524	42.23
		1pc		P-UB-10	1-3/4	3	JIC-G105549	42.54
LOADER GRAPPLE				P-U-1	1-1/2		JIC-D42869	17.66
		1pc		P-UB-10	1-1/2	2-1/2	JIC-G105550	25.09
		2pc		N-N-9		2-1/2	JIC-G33193	14.17
		2pc		P-U-9	1-1/2	2-1/2	JIC-G32294	26.40
LOADER HYDRA-LEVELING		2pc		P-U-9	1-1/2	2-1/2	JIC-G32294	26.40
		1pc		P-UB-10	1-1/2	2-1/2	JIC-G105550	25.09
		2pc		N-N-9		2-1/2	JIC-G33193	14.17
				P-U-1	1-1/2		JIC-D42869	17.66
LOADER LIFT		2pc		P-U-9	1-3/4	3	JIC-G34643	33.74
		1pc		P-UB-10	1-3/4	3	JIC-G105549	42.54
		2pc		P-UB-9	1-3/4	3	JIC-G105524	42.23
		2pc		N-N-9		3	JIC-G33151	14.53
				P-U-1	1-3/4		JIC-D42872	13.12
LOADER TILT		1pc		P-UB-10	1-1/2	2-1/2	JIC-G105550	25.09
		2pc		P-U-9	1-1/2	2-1/2	JIC-G32294	26.40
				P-U-1	1-1/2		JIC-D42869	17.66
		2pc		N-N-9		2-1/2	JIC-G33193	14.17
RIPPER		1pc		P-UB-10	1-1/2	3	JIC-G105548	33.43
				P-U-1	1-1/2		JIC-D42870	17.52
		2pc		N-N-9		3	JIC-G33151	14.53
		2pc		P-UB-9	1-1/2	3	JIC-G105512	38.33
MODEL 350B with Backhoe Models 26C, 26D								
BACKHOE BOOM		2pc		P-UB-9	2-1/2	4	JIC-G34636	44.02
		1pc		P-UB-10	2-1/4	4	JIC-G105556	43.45
		1pc		P-UB-10	1-3/4	4	JIC-G105552	40.06
BACKHOE BUCKET		1pc		P-UB-10	2	3-1/4	JIC-G105553	42.15
		1pc		P-UB-10	1-3/4	3	JIC-G105549	42.54
		2pc		P-UB-9	1-3/4	3	JIC-G105524	42.23
BACKHOE DIPPER		1pc		P-UB-10	2	3-1/2	JIC-G105546	37.63
		2pc		P-UB-9	2	3-1/2	JIC-G105527	42.05
BACKHOE DIPPER EXT		1pc		P-UB-10	1-1/2	3	JIC-G105548	33.43
		2pc		P-UB-9	1-1/2	3	JIC-G105512	38.33
BACKHOE STABILIZER		1pc		P-UB-10	1-3/4	3	JIC-G105549	42.54
		2pc		P-U-9	1-3/4	3-1/2	JIC-G105518	38.14
BACKHOE SWING		2pc		P-U-9	1-1/2	3-1/2	JIC-G34652	33.57
		1pc		P-UB-10	1-1/2	3-1/2	JIC-G105555	31.46
DOZER ANGLE		1pc		P-UB-10	1-1/2	3	JIC-G109452	25.39



CASE

Replacement Kits For

Track-Type Dozers/Loaders								
APPLICATION	CYL #	Piston	SERIAL #	CODE	ROD	BORE	KIT #	List \$
MODEL 350B with Backhoe Models 26C, 26D								
DOZER LIFT		1pc		P-UB-10	1-1/4	2-1/2	JIC-G109475	28.43
DOZER TILT		1pc		P-UB-10	1-1/4	2-1/2	JIC-G109475	28.43
LOADER CLAM		1pc		P-UB-10	1-3/4	3	JIC-1543262C1	34.76
LOADER LIFT		1pc		P-UB-10	1-3/4	3	JIC-1543262C1	34.76
LOADER TILT		1pc		P-UB-10	1-1/2	2-1/2	JIC-1543253C1	36.88
RIPPER		1pc		P-UB-10	1-1/2	3	JIC-G109452	25.39
MODEL 420C								
BACKHOE BOOM				I-U-1	2		JIC-D42876	14.20
		2pc		N-N-9		4	JIC-G33239	17.54
BACKHOE BUCKET				P-U-1	1-3/4		JIC-D42873	17.99
		2pc		N-N-9		3-1/2	JIC-G33237	16.09
BACKHOE DIPPER				I-U-1	2		JIC-D42876	14.20
		2pc		N-N-9		4	JIC-G33239	17.54
BACKHOE STABILIZER				P-U-1	1-3/4		JIC-D42873	17.99
		2pc		N-N-9		3-1/2	JIC-G33237	16.09
DOZER ANGLING				P-U-1	1-3/4		JIC-D42873	17.99
		2pc		N-N-9		3-1/2	JIC-G33237	16.09
DOZER LIFT				P-U-1	1-1/4		JIC-D42867	14.05
		2pc		N-N-9		4	JIC-G33239	17.54
DOZER TILT		2pc		N-N-9		4	JIC-G33239	17.54
				P-U-1	1-1/4		JIC-D42867	14.05
LOADER LIFT		2pc		N-N-9		3-1/2	JIC-G33237	16.09
				P-U-1	1-3/4		JIC-D42873	17.99
LOADER TILT				P-U-1	1-1/4		JIC-D42867	14.05
		2pc		N-N-9		4	JIC-G33239	17.54
SCARIFIER		2pc		N-N-9		4	JIC-G33239	17.54
				P-U-1	1-1/2		JIC-D42870	17.52
MODEL 450 with Backhoe Models 26, 26B, 26C, 26S, 32, 33, 35								
BACKHOE BOOM		2pc		N-N-9		4-1/2	JIC-DTVS4.5P	34.76
		1pc		P-UB-10	1-3/4	3-1/4	JIC-G105547	38.44
		2pc		P-UB-9	2	4	JIC-G105517	38.79
		1pc		P-UB-10	2-1/4	4	JIC-G105556	43.45
				P-U-1	1-3/4		JIC-D42873	17.99
				P-U-1	2-1/4		JIC-D42878	15.98
		2pc		P-UB-9	2-1/2	4	JIC-G34636	44.02
		2pc		N-N-9		4	JIC-G33239	17.54
		2pc		P-UB-9	1-3/4	3-1/2	JIC-G105529	35.77
				I-U-1	2		JIC-D42876	14.20
		2pc		P-UB-9	1-3/4	3-1/4	JIC-G105528	36.68
		2pc		P-UB-9	2-1/4	4-1/2	JIC-G105520	62.28
		2pc		N-N-9		3-1/2	JIC-G33237	16.09
		2pc		P-U-9	2	4	JIC-G32299	38.14
BACKHOE BUCKET		2pc		P-U-9	2	3-1/2	JIC-G32293	34.48
		2pc		P-UB-9	2	3-1/2	JIC-G105527	42.05
		1pc		P-UB-10	2	3-1/2	JIC-G105546	37.63
				I-U-1	2		JIC-D42874	11.82

CASE



CASE

Replacement Kits For

Track-Type Dozers/Loaders								
APPLICATION	CYL #	Piston	SERIAL #	CODE	ROD	BORE	KIT #	List \$
MODEL 450 with Backhoe Models 26, 26B, 26C, 26S, 32, 33, 35								
BACKHOE BUCKET		2pc		P-UB-9	1-3/4	3	JIC-G105524	42.23
		1pc		P-UB-10	1-3/4	3	JIC-G105549	42.54
				P-U-1	1-3/4		JIC-D42872	13.12
				P-U-1	1-3/4		JIC-D42873	17.99
		2pc		N-N-9		3-1/2	JIC-G33237	16.09
BACKHOE DIPPER		2pc		P-UB-9	2	3-1/2	JIC-G105527	42.05
		2pc		N-N-9		3-1/2	JIC-G33237	16.09
		2pc		N-N-9		4	JIC-G33239	17.54
		2pc		P-U-9	2	3-1/2	JIC-G32293	34.48
				I-U-1	2		JIC-D42876	14.20
		2pc		P-U-9	2	4	JIC-G32299	38.14
		1pc		P-UB-10	2	3-1/2	JIC-G105546	37.63
				I-U-1	2		JIC-D42874	11.82
		2pc		P-UB-9	2	4	JIC-G105517	38.79
		1pc		P-UB-10	2	4	JIC-1543273C1	47.24
BACKHOE DIPPER EXT		2pc		P-UB-10	1-1/2	3	JIC-G105548	33.43
		2pc		P-UB-9	1-1/2	3	JIC-G105512	38.33
		2pc		P-U-1	1-3/4		JIC-D42873	17.99
		2pc		P-UB-9	1-3/4	3-1/2	JIC-G105529	35.77
		2pc		N-N-9		3-1/2	JIC-G33237	16.09
BACKHOE STABILIZER				P-U-1	1-3/4		JIC-D42873	17.99
		2pc		P-U-9	1-3/4	3-1/2	JIC-G105518	38.14
		1pc		P-UB-10	2	4	JIC-1543273C1	47.24
				P-U-1	1-3/4		JIC-D42872	13.12
				P-U-1	1-1/2		JIC-D42870	17.52
		2pc		P-UB-9	1-3/4	3-1/2	JIC-G105529	35.77
		2pc		N-N-9		3-1/2	JIC-G33237	16.09
		2pc		P-UB-9	2	4	JIC-G105517	38.79
		2pc		N-N-9		3	JIC-G33151	14.53
		2pc		P-UB-9	1-3/4	3	JIC-G105524	42.23
BACKHOE SWING				P-U-1	1-3/4		JIC-D42875	13.93
		1pc		P-UB-10	2	4	JIC-1543273C1	47.24
		2pc		P-UB-9	1-3/4	4	JIC-G105519	36.58
		2pc		N-N-9		3-1/2	JIC-G33237	16.09
		2pc		N-N-9		4	JIC-G33239	17.54
		1pc		P-UB-10	1-1/2	3-1/2	JIC-G105555	31.46
		2pc		P-UB-9	2	4	JIC-G105517	38.79
				P-U-1	1-1/2		JIC-D47896	14.14
DOZER ANGLING (Angle Dozer)		2pc		P-UB-9	1-1/2	2	JIC-G105503	31.83
		2pc		I-U-9	1-1/2	2	JIC-D37361	22.01
DOZER ANGLING (Angle Tilt Dozer)		1pc		P-UB-10	2	4	JIC-1543273C1	47.24
		2pc		P-UB-9	2	4	JIC-G105526	40.35
		2pc		N-N-9		4	JIC-G33239	17.54



CASE

Replacement Kits For

Track-Type Dozers/Loaders								
APPLICATION	CYL #	Piston	SERIAL #	CODE	ROD	BORE	KIT #	List \$
MODEL 450 with Backhoe Models 26, 26B, 26C, 26S, 32, 33, 35								
DOZER ANGLING (Angle Tilt Dozer)				I-U-1	2		JIC-D42876	14.20
DOZER LIFT		2pc		P-U-9	1-1/4	2-1/2	JIC-G32295	31.87
				P-U-1	1-1/4		JIC-D42867	14.05
		1pc		P-UB-10	1-1/4	2-1/2	JIC-G105551	28.43
		2pc		N-N-9		2-1/2	JIC-G33193	14.17
DOZER TILT		1pc		P-UB-10	2	3-1/2	JIC-G105546	37.63
				I-U-1	2		JIC-D42874	11.82
		2pc		P-UB-9	2	3-1/2	JIC-G105521	36.68
		2pc		N-N-9		3-1/2	JIC-G33237	16.09
		2pc		P-U-9	2	3-1/2	JIC-G34648	38.89
LOADER CLAM		2pc		N-N-9		3	JIC-G33151	14.53
				P-U-1	1-1/2		JIC-D42870	17.52
		2pc		P-UB-9	1-1/2	3	JIC-G105512	38.33
		1pc		P-UB-10	1-1/2	3	JIC-G105548	33.43
LOADER HYDRA-LEVELING				P-U-1	1-3/4		JIC-D42872	13.12
		1pc		P-UB-10	1-3/4	3	JIC-G105549	42.54
		2pc		P-UB-9	1-3/4	3	JIC-G105524	42.23
		2pc		N-N-9		3	JIC-G33151	14.53
LOADER LIFT		2pc		N-N-9		3-1/2	JIC-G33237	16.09
		2pc		P-U-9	2	3-1/2	JIC-G34648	38.89
		2pc		P-UB-9	2	3-1/2	JIC-G105521	36.68
		1pc		P-UB-10	2	3-1/2	JIC-G105546	37.63
				I-U-1	2		JIC-D42874	11.82
LOADER TILT		2pc		N-N-9		3	JIC-G33151	14.53
		1pc		P-UB-10	1-3/4	3	JIC-G105549	42.54
				P-U-1	1-3/4		JIC-D42872	13.12
		2pc		P-U-9	1-3/4	3	JIC-G34643	33.74
		2pc		P-UB-9	1-3/4	3	JIC-G105524	42.23
RIPPER		1pc		P-UB-10	1-1/2	3	JIC-G105548	33.43
		2pc		P-UB-9	1-1/2	3	JIC-G105512	38.33
		2pc		N-N-9		3-1/2	JIC-G33237	16.09
				P-U-1	1-1/2		JIC-D42870	17.52
MODEL 450B, 450C, 455B, 455C with Backhoe Models 26D, 35								
BACKHOE BOOM		1pc		P-UB-10	1-3/4	4	JIC-G105552	40.06
		2pc		P-UB-9	1-3/4	3-1/4	JIC-G105528	36.68
		1pc		P-UB-10	1-3/4	3-1/4	JIC-G105547	38.44
BACKHOE BUCKET		2pc		P-UB-9	2	3-1/2	JIC-G105527	42.05
		1pc		P-UB-10	2	3-1/4	JIC-G105553	42.15
		1pc		P-UB-10	2	3-1/2	JIC-G105546	37.63
BACKHOE DIPPER		1pc		P-UB-10	2	4	JIC-1543273C1	47.24
		2pc		P-UB-9	2	4	JIC-G105517	38.79
		1pc		P-UB-10	2	3-1/2	JIC-G105546	37.63
BACKHOE DIPPER EXT		1pc		P-UB-10	1-1/2	3	JIC-G105548	33.43
		2pc		P-UB-9	1-1/2	3	JIC-G105512	38.33

CASE



CASE

Replacement Kits For

Track-Type Dozers/Loaders								
APPLICATION	CYL #	Piston	SERIAL #	CODE	ROD	BORE	KIT #	List \$
MODEL 450B, 450C, 455B, 455C with Backhoe Models 26D, 35								
BACKHOE STABILIZER		1pc		P-UB-10	1-3/4	3	JIC-G105549	42.54
		2pc		P-UB-9	2	4	JIC-G105517	38.79
		1pc		P-UB-10	2	4	JIC-1543273C1	47.24
BACKHOE SWING		2pc		P-UB-10	2	4	JIC-1543273C1	47.24
		2pc		P-UB-9	2	4	JIC-G105517	38.79
		1pc		P-UB-10	1-1/2	3-1/2	JIC-G105555	31.46
DOZER ANGLE		1pc		P-UB-10	2	4	JIC-1543273C1	47.24
DOZER LIFT		1pc		P-UB-10	1-1/4	2-1/2	JIC-G105551	28.43
DOZER TILT		1pc		P-UB-10	2	3-1/2	JIC-G105546	37.63
LOADER CLAM		1pc		P-UB-10	1-1/2	3	JIC-G105548	33.43
LOADER HYDRA-LEVELING		1pc		P-UB-10	2	4	JIC-1543273C1	47.24
LOADER LIFT		1pc		P-UB-10	2	3-1/2	JIC-G105546	37.63
LOADER TILT		1pc		P-UB-10	1-1/2	3	JIC-G105548	33.43
RIPPER		1pc		P-UB-10	1-1/2	3	JIC-G105548	33.43
MODEL 475 Cable Layer								
DOZER TILT		2pc		P-U-9	2	3-1/2	JIC-G34648	38.89
		1pc		P-UB-10	2	3-1/2	JIC-G105546	37.63
PLOW LIFT		2pc		P-UB-9	2	4-1/2	JIC-G105525	49.88
PLOW SWING		1pc		P-UB-10	1-1/2	3-1/2	JIC-G105555	31.46
		2pc		P-U-9	1-1/2	3-1/2	JIC-G34646	33.01
REEL & DOZER LIFT		2pc		P-U-9	1-1/4	2-1/2	JIC-G32295	31.87
		1pc		P-UB-10	1-1/4	2-1/2	JIC-G105551	28.43
MODEL 550E								
ANGLE	140146A1			P-UB-10	2	4	JIC-1543273C1	47.24
LIFT	1542565C1			I-UB-10	1-1/2	2-1/2	JIC-1542764C2	44.07
RIPPER	G101230			P-UB-10	1-1/2	3	JIC-1543252C1	36.15
TILT	1542717C1			P-UB-10	1-1/2	3	JIC-1543256C1	34.04
MODEL 550G								
ANGLE	140146A1			P-UB-10	2	4	JIC-1543273C1	47.24
LIFT	1542565C1			I-UB-10	1-1/2	2-1/2	JIC-1542764C2	44.07
RIPPER	G101230			P-UB-10	1-1/2	3	JIC-1543252C1	36.15
TILT	1542717C1			P-UB-10	1-1/2	3	JIC-1543256C1	34.04
MODEL 650G								
ANGLE	116969A1			P-UB-10	1-3/4	3-1/2	JIC-1543266C1	42.86
	190595A1			P-UB-10	1-3/4	3-1/2	JIC-1543266C1	42.86
LIFT	116211A1			P-UB-10	1-3/4	3-1/2	JIC-1543266C1	42.86
RIPPER	G101214			P-UB-10	1-3/4	3-1/4	JIC-1543265C1	43.07
	G101215			P-UB-10	1-3/4	3-1/4	JIC-1543265C1	43.07
TILT	117511A1			P-UB-10	1-3/4	3-1/2	JIC-1543266C1	42.86
MODEL 750 with Backhoe Models 32, 33S, 34								
BACKHOE BOOM		2pc		P-U-9	2	4	JIC-G32299	38.14
				I-U-1	2		JIC-D42876	14.20
				P-U-1	2-1/4		JIC-D42878	15.98
		2pc		N-N-9		4-1/2	JIC-DTVS4.5P	34.76
		2pc		P-UB-9	2-1/4	4-1/2	JIC-G105520	62.28



CASE

Replacement Kits For

Track-Type Dozers/Loaders								
APPLICATION	CYL #	Piston	SERIAL #	CODE	ROD	BORE	KIT #	List \$
MODEL 750 with Backhoe Models 32, 33S, 34								
BACKHOE BOOM		2pc		N-N-9		4	JIC-G33239	17.54
BACKHOE BUCKET		2pc		N-N-9		4	JIC-G33239	17.54
				P-U-1	1-3/4		JIC-D42873	17.99
				I-U-1	2		JIC-D42874	11.82
		2pc		N-N-9		3-1/2	JIC-G33237	16.09
				I-U-1	2-1/4		JIC-D42877	13.02
		2pc		P-U-9	2	3-1/2	JIC-G32293	34.48
BACKHOE DIPPER		2pc		P-U-9	2	4	JIC-G32299	38.14
				P-U-1	2-1/4		JIC-D42878	15.98
		2pc		N-N-9		4-1/2	JIC-DTVS4.5P	34.76
				I-U-1	2		JIC-D42876	14.20
		2pc		N-N-9		4	JIC-G33239	17.54
BACKHOE STABILIZER		2pc		P-UB-9	1-3/4	3-1/2	JIC-G105529	35.77
				P-U-1	1-3/4		JIC-D42873	17.99
		2pc		N-N-9		3-1/2	JIC-G33237	16.09
BACKHOE SWING		2pc		P-UB-9	1-3/4	4	JIC-G105519	36.58
				P-U-1	1-3/4		JIC-D42875	13.93
		2pc		N-N-9		4	JIC-G33239	17.54
DOZER ANGLE		2pc		I-U-9	1-1/2	2-1/2	JIC-D37360	24.05
DOZER TILT		2pc		N-N-9		3-1/2	JIC-G33237	16.09
				P-U-1	1-3/4		JIC-D42873	17.99
LOADER LIFT		2pc		N-N-9		3	JIC-G33151	14.53
				P-U-1	1-1/2		JIC-D42870	17.52
LOADER TILT				I-U-1	2		JIC-D42876	14.20
		2pc		N-N-9		4	JIC-G33239	17.54
RIPPER				P-U-1	1-3/4		JIC-D42873	17.99
		2pc		N-N-9		3-1/2	JIC-G33237	16.09
MODEL 750H								
ANGLE	190595A1			P-UB-10	1-3/4	3-1/2	JIC-1543266C1	42.86
LIFT	116211A2			P-UB-10	1-3/4	3-1/2	JIC-1543266C1	42.86
RIPPER	G101214			P-UB-10	1-3/4	3-1/4	JIC-1543265C1	43.07
	G101215			P-UB-10	1-3/4	3-1/4	JIC-1543265C1	43.07
TILT	117511A2			P-UB-10	1-3/4	3-1/2	JIC-1543266C1	42.86
MODEL 850 with Backhoe Models 34, 35, 36								
BACKHOE BOOM				P-U-1	2-1/4		JIC-D42878	15.98
		2pc		P-U-9	2-1/4	5	JIC-G32696	49.15
		2pc		P-UB-9	1-3/4	3-1/4	JIC-G105528	36.68
		1pc		P-UB-10	1-3/4	3-1/4	JIC-G105547	38.44
		2pc		N-N-9		4-1/2	JIC-DTVS4.5P	34.76
BACKHOE BUCKET		2pc		N-N-9		4	JIC-G33239	17.54
		2pc		P-UB-9	2	3-1/2	JIC-G105527	42.05
		1pc		P-UB-10	2	3-1/2	JIC-G105546	37.63
				I-U-1	2-1/4		JIC-D42877	13.02
		2pc		P-UB-9	2-1/2	4	JIC-G34636	44.02
BACKHOE DIPPER		1pc		P-UB-10	2	4	JIC-1543273C1	47.24
		2pc		P-UB-9	2-1/4	4-1/2	JIC-G105520	62.28

CASE



CASE

Replacement Kits For

Track-Type Dozers/Loaders								
APPLICATION	CYL #	Piston	SERIAL #	CODE	ROD	BORE	KIT #	List \$
MODEL 850 with Backhoe Models 34, 35, 36								
BACKHOE DIPPER				P-U-1	2-1/4		JIC-D42878	15.98
		2pc		P-UB-9	2	4	JIC-G105517	38.79
		2pc		N-N-9		4-1/2	JIC-DTVS4.5P	34.76
		2pc		P-UB-9	2-1/2	4-1/2	JIC-G105513	64.23
BACKHOE DIPPER EXT		2pc		P-UB-9	1-1/2	3	JIC-G105512	38.33
		1pc		P-UB-10	1-1/2	3	JIC-G105548	33.43
BACKHOE STABILIZER		2pc		N-N-9		4	JIC-G33239	17.54
				I-U-1	2		JIC-D42876	14.20
		2pc		P-UB-9	2	4	JIC-G105517	38.79
		2pc		P-U-9	2	4	JIC-G32299	38.14
		1pc		P-UB-10	2	4	JIC-1543273C1	47.24
BACKHOE SWING		2pc		N-N-9		4	JIC-G33239	17.54
		2pc		P-U-9	2	4-1/2	JIC-G32695	51.36
		2pc		P-UB-9	2	4-1/2	JIC-G105525	49.88
		1pc		P-UB-10	2	4	JIC-1543273C1	47.24
		2pc		P-UB-9	2	4	JIC-G105517	38.79
				P-U-1	1-3/4		JIC-D42875	13.93
DOZER ANGLING		2pc		I-U-9	1-1/2	2-1/2	JIC-D37360	24.05
		2pc		P-UB-9	1-1/2	2-1/2	JIC-G105505	25.97
DOZER LIFT		2pc		N-N-9		3	JIC-G33151	14.53
		2pc		P-UB-9	1-1/2	3	JIC-G105512	38.33
				P-U-1	1-1/2		JIC-D42870	17.52
DOZER TILT		2pc		P-U-9	1-3/4	3-1/2	JIC-G105518	38.14
				P-U-1	1-3/4		JIC-D42873	17.99
		2pc		N-N-9		3-1/2	JIC-G33237	16.09
DOZER TILT & PITCH		2pc		P-UB-9	2	3-1/2	JIC-G105521	36.68
LOADER CLAM		2pc		P-U-9	2	4	JIC-G32299	38.14
LOADER HYDRA-LEVELING		2pc		N-N-9		4	JIC-G33239	17.54
		2pc		P-UB-9	2	4	JIC-G105517	38.79
				I-U-1	2		JIC-D42876	14.20
		2pc		P-U-9	2	4	JIC-G32299	38.14
LOADER LIFT		2pc		N-N-9		4-1/2	JIC-DTVS4.5P	34.76
				P-UB-9	2-1/4	4-1/2	JIC-G105520	62.28
				P-U-1	2-1/4		JIC-D42878	15.98
LOADER TILT		2pc		P-U-9	1-3/4	3-1/2	JIC-G105508	41.52
		2pc		P-U-9	1-3/4	3-1/2	JIC-G32228	34.04
				P-U-1	1-3/4		JIC-D42873	17.99
		2pc		N-N-9		3-1/2	JIC-G33237	16.09
RIPPER		2pc		P-U-9	1-3/4	4	JIC-G34626	39.61
		2pc		N-N-9		4	JIC-G33239	17.54
				P-U-1	1-3/4		JIC-D42875	13.93
MODEL 850B with Backhoe Model 35								
BACKHOE BOOM		2pc		P-UB-9	1-3/4	3-1/4	JIC-G105528	36.68
		1pc		P-UB-10	1-3/4	3-1/4	JIC-G105547	38.44
BACKHOE BUCKET		1pc		P-UB-10	2	3-1/2	JIC-G105546	37.63



CASE

Replacement Kits For

Track-Type Dozers/Loaders								
APPLICATION	CYL #	Piston	SERIAL #	CODE	ROD	BORE	KIT #	List \$
MODEL 850B with Backhoe Model 35								
BACKHOE BUCKET		2pc		P-UB-9	2	3-1/2	JIC-G105527	42.05
BACKHOE DIPPER		1pc		P-UB-10	2	4	JIC-1543273C1	47.24
		2pc		P-UB-9	2	4	JIC-G105517	38.79
BACKHOE DIPPER EXT		1pc		P-UB-10	1-1/2	3	JIC-G105548	33.43
		2pc		P-UB-9	1-1/2	3	JIC-G105512	38.33
BACKHOE STABILIZER		1pc		P-UB-10	2	4	JIC-1543273C1	47.24
		2pc		P-UB-9	2	4	JIC-G105517	38.79
BACKHOE SWING		1pc		P-UB-10	2	4	JIC-1543273C1	47.24
		2pc		P-UB-9	2	4	JIC-G105517	38.79
DOZER ANGLE		2pc		P-UB-9	2	4-1/2	JIC-G105525	49.88
DOZER LIFT		1pc		P-UB-10	1-3/4	3	JIC-G105549	42.54
		1pc		P-UB-10	1-1/2	3	JIC-G105548	33.43
DOZER TILT		1pc		P-UB-10	2	4	JIC-1543273C1	47.24
		1pc		P-UB-10	1-3/4	4	JIC-G105552	40.06
LOADER CLAM		1pc		P-UB-10	2	3-1/2	JIC-G105546	37.63
LOADER LIFT		1pc		P-UB-10	2	4	JIC-1543273C1	47.24
LOADER TILT		1pc		P-UB-10	2	3-1/2	JIC-G105546	37.63
RIPPER		1pc		P-UB-10	1-3/4	3-1/4	JIC-G105547	38.44
MODEL 850C, 855C with Backhoe Models 35A, 35A, 35C WL, 3								
BACKHOE BOOM		1pc		P-UB-10	1-3/4	3-1/4	JIC-G105547	38.44
BACKHOE BUCKET		1pc		P-UB-10	2-1/2	4	JIC-G109424	43.95
		1pc		P-UB-10	2	3-1/2	JIC-G105546	37.63
		1pc		P-UB-10	2-1/2	3-1/2	JIC-G109504	37.16
BACKHOE DIPPER		1pc		P-UB-10	2	4	JIC-1543273C1	47.24
BACKHOE DIPPER EXT		1pc		P-UB-10	1-1/2	3	JIC-G105548	33.43
BACKHOE STABILIZER		1pc		P-UB-10	2	4	JIC-1543273C1	47.24
BACKHOE SWING		1pc		P-UB-10	2	4	JIC-1543273C1	47.24
DOZER ANGLE		2pc		P-UB-9	2	4-1/2	JIC-G105525	49.88
DOZER LIFT		1pc		P-UB-10	1-1/2	3	JIC-G105548	33.43
		1pc		P-UB-10	1-3/4	3	JIC-G105549	42.54
DOZER TILT		1pc		P-UB-10	2	4	JIC-1543273C1	47.24
				P-UB-10	1-3/4	4	JIC-G105552	40.06
LOADER CLAM		1pc		P-UB-10	2	3-1/2	JIC-G105546	37.63
LOADER LIFT		1pc		P-UB-10	2	4	JIC-1543273C1	47.24
LOADER TILT		1pc		P-UB-10	2	3-1/2	JIC-G105546	37.63
RIPPER		1pc		P-UB-10	1-3/4	3-1/4	JIC-G105547	38.44
MODEL 850D with Backhoe Models 35C, 35C WL								
BACKHOE BOOM		1pc		P-UB-10	1-3/4	3-1/4	JIC-1543265C1	43.07
BACKHOE BUCKET		1pc		P-UB-10	2-1/2	3-1/2	JIC-G109504	37.16
		1pc		P-UB-10	2-1/2	4	JIC-G109424	43.95
BACKHOE DIPPER		1pc		P-UB-10	2	4	JIC-1543273C1	47.24
BACKHOE DIPPER EXT		1pc		P-UB-10	1-1/2	3	JIC-G109452	25.39
BACKHOE STABILIZER		1pc		P-UB-10	2	4	JIC-1543273C1	47.24
BACKHOE SWING		1pc		P-UB-10	2	4	JIC-1543273C1	47.24
DOZER LIFT		1pc		P-UB-10	1-1/2	3	JIC-G109452	25.39
DOZER TILT		1pc		P-UB-10	2	4	JIC-1543273C1	47.24

CASE



CASE

Replacement Kits For

Track-Type Dozers/Loaders

APPLICATION	CYL #	Piston	SERIAL #	CODE	ROD	BORE	KIT #	List \$
MODEL 850D with Backhoe Models 35C, 35C WL								
LOADER CLAM		1pc		P-UB-10	2	3-1/2	JIC-G109453	37.63
LOADER LIFT		1pc		P-UB-10	2	4	JIC-1543273C1	47.24
LOADER TILT		1pc		P-UB-10	2	3-1/2	JIC-G109453	37.63
RIPPER		1pc		P-UB-10	1-3/4	3-1/4	JIC-1543265C1	43.07
MODEL 850E, 855E								
DOZER ANGLE	1542644C1			P-UB-10	2	4	JIC-1543273C1	47.24
	G103467			P-UB-9	2	4-1/2	JIC-1543270C1	60.90
DOZER LIFT	G101217			P-UB-10	1-1/2	3	JIC-1543252C1	36.15
DOZER TILT	G109485			P-UB-10	2	4	JIC-1543273C1	47.24
LOADER BUCKET	G101210			P-UB-10	2	3-1/2	JIC-1543274C1	48.24
LOADER CLAM	G101211			P-UB-10	2	3-1/2	JIC-1543274C1	48.24
LOADER LIFT L/H	G101213			P-UB-10	2	4	JIC-1543273C1	47.24
LOADER LIFT R/H	G101212			P-UB-10	2	4	JIC-1543273C1	47.24
RIPPER L/H	G101215			P-UB-10	1-3/4	3-1/4	JIC-1543265C1	43.07
RIPPER R/H	G101214			P-UB-10	1-3/4	3-1/4	JIC-1543265C1	43.07
MODEL 850G								
ANGLE	116969A1			P-UB-10	1-3/4	3-1/2	JIC-1543266C1	42.86
	190595A1			P-UB-10	1-3/4	3-1/2	JIC-1543266C1	42.86
LIFT	116211A1			P-UB-10	1-3/4	3-1/2	JIC-1543266C1	42.86
RIPPER L/H	G101215			P-UB-10	1-3/4	3-1/4	JIC-1543265C1	43.07
RIPPER R/H	G101214			P-UB-10	1-3/4	3-1/4	JIC-1543265C1	43.07
TILT	117511A1			P-UB-10	1-3/4	3-1/2	JIC-1543266C1	42.86
MODEL 1150 with Backhoe Models 32, 34, 36								
BACKHOE BOOM				I-U-1	2		JIC-D42876	14.20
		2pc		N-N-9		4	JIC-G33239	17.54
		2pc		P-U-9	2-1/4	5	JIC-G32696	49.15
				P-U-1	2-1/4		JIC-D42878	15.98
		2pc		N-N-9		4-1/2	JIC-DTVS4.5P	34.76
BACKHOE BUCKET				I-U-1	2-1/4		JIC-D42877	13.02
		2pc		N-N-9		4	JIC-G33239	17.54
		2pc		N-N-9		3-1/2	JIC-G33237	16.09
				P-U-1	1-3/4		JIC-D42873	17.99
		2pc		P-UB-9	2-1/2	4	JIC-G34636	44.02
BACKHOE DIPPER				P-U-1	2-1/4		JIC-D42878	15.98
				I-U-1	2		JIC-D42876	14.20
		2pc		N-N-9		4-1/2	JIC-DTVS4.5P	34.76
		2pc		N-N-9		4	JIC-G33239	17.54
		2pc		P-UB-9	2-1/2	4-1/2	JIC-G105513	64.23
		2pc		P-UB-9	2-1/4	4-1/2	JIC-G105520	62.28
BACKHOE STABILIZER		2pc		P-U-9	2	4	JIC-G32299	38.14
		2pc		N-N-9		4	JIC-G33239	17.54
				P-U-1	1-3/4		JIC-D42873	17.99
		2pc		P-UB-9	2	4	JIC-G105517	38.79
		2pc		N-N-9		3-1/2	JIC-G33237	16.09
				I-U-1	2		JIC-D42876	14.20
BACKHOE SWING		2pc		N-N-9		4	JIC-G33239	17.54



CASE

Replacement Kits For

Track-Type Dozers/Loaders								
APPLICATION	CYL #	Piston	SERIAL #	CODE	ROD	BORE	KIT #	List \$
MODEL 1150 with Backhoe Models 32, 34, 36								
BACKHOE SWING		2pc		P-U-9	2	4-1/2	JIC-G32695	51.36
		2pc		P-UB-9	2	4-1/2	JIC-G105525	49.88
				P-U-1	1-3/4		JIC-D42875	13.93
DOZER LIFT		2pc		P-UB-9	1-3/4	3-1/2	JIC-G105529	35.77
		2pc		P-U-9	1-3/4	3-1/2	JIC-G105508	41.52
				P-U-1	1-3/4		JIC-D42873	17.99
		2pc		P-U-9	1-3/4	3-1/2	JIC-G105518	38.14
		2pc		N-N-9		3-1/2	JIC-G33237	16.09
DOZER TILT				P-U-1	1-3/4		JIC-D42873	17.99
		2pc		P-U-9	1-3/4	3-1/2	JIC-G105518	38.14
		2pc		N-N-9		3-1/2	JIC-G33237	16.09
LOADER CLAM		2pc		N-N-9		4	JIC-G33239	17.54
		2pc		P-U-9	2	4	JIC-G32299	38.14
		2pc		P-UB-9	2-1/4	4-1/2	JIC-G105520	62.28
				I-U-1	2		JIC-D42876	14.20
LOADER LIFT		2pc		P-U-9	2-1/2	5-1/2	JIC-G33823	46.63
LOADER TILT		2pc		P-U-9	2-1/4	5	JIC-G32696	49.15
PIPPER		2pc		P-UB-9	2	4	JIC-G105526	40.35
		2pc		P-UB-9	2	4	JIC-G105517	38.79
		2pc		N-N-9		4	JIC-G33239	17.54
				I-U-1	2		JIC-D42876	14.20
MODEL 1150B								
DOZER ANGLE		1pc		P-UB-10	1-3/4	3	JIC-G105549	42.54
		2pc		P-U-9	1-3/4	3	JIC-G34643	33.74
		2pc		P-UB-9	1-3/4	3	JIC-G105523	36.68
DOZER TILT		2pc		P-UB-9	2-1/4	4-1/2	JIC-G105520	62.28
DOZER TILT & PITCH		2pc		P-UB-9	2-1/2	4	JIC-G34636	44.02
		1pc		P-UB-10	2-1/4	4	JIC-G105556	43.45
FELLER BUNCHER		2pc		P-UB-9	2-1/4	4-1/2	JIC-G105520	62.28
LOADER CLAM		2pc		P-UB-9	2-1/4	4-1/2	JIC-G105520	62.28
LOADER LIFT		2pc		P-U-9	2-1/4	5	JIC-G32696	49.15
		2pc		P-UB-9	2-1/4	5	JIC-G105530	62.35
LOADER TILT		2pc		P-UB-9	2-1/4	4-1/2	JIC-G105520	62.28
RIPPER		2pc		P-UB-9	2	4	JIC-G105526	40.35
		1pc		P-UB-10	2	4	JIC-1543273C1	47.24
MODEL 1150C, 1150D, 1155D								
DOZER ANGLE		1pc		P-UB-10	1-3/4	3	JIC-1543262C1	34.76
DOZER LIFT		1pc		P-UB-10	1-3/4	3-1/2	JIC-G109471	36.68
DOZER TILT		2pc		P-UB-9	2-1/4	4-1/2	JIC-G105520	62.28
DOZER TILT & PITCH		1pc		P-UB-10	2-1/4	4	JIC-G109505	39.90
LOADER CLAM		2pc		P-UB-9	2-1/4	4-1/2	JIC-G105520	62.28
LOADER LIFT		2pc		P-UB-9	2-1/4	5	JIC-G109501	57.69
LOADER TILT		2pc		P-UB-9	2-1/4	4-1/2	JIC-G105520	62.28
RIPPER		1pc		P-UB-10	2	4	JIC-1543273C1	47.24
MODEL 1150G								
ANGLE	G110702			P-UB-10	2-1/2	5	JIC-1542915C2	51.36

CASE



CASE

Replacement Kits For

Track-Type Dozers/Loaders

APPLICATION	CYL #	Piston	SERIAL #	CODE	ROD	BORE	KIT #	List \$
MODEL 1150G								
LIFT	G109819			P-UB-10	1-3/4	3-1/4	JIC-1543265C1	43.07
RIPPER	G101272			P-UB-10	2	4	JIC-1543273C1	47.24
	G101273			P-UB-10	2	4	JIC-1543273C1	47.24
TILT	G110694			P-UB-10	2-1/2	5	JIC-1542915C2	51.36
MODEL 1450								
DOZER ANGLE		1pc		P-UB-10	2	4	JIC-1543273C1	47.24
DOZER LIFT		1pc		P-UB-10	2	4	JIC-1543273C1	47.24
		2pc		P-UB-9	2	4	JIC-G105517	38.79
DOZER TILT		2pc		P-UB-9	3	6	JIC-G105516	64.64
DOZER TILT & PITCH		2pc		P-UB-9	2-1/2	5	JIC-G105515	52.56
LOADER CLAM		2pc		P-UB-9	2-1/4	4-1/2	JIC-G105520	62.28
LOADER LIFT		2pc		P-UB-9	2-1/2	5-1/2	JIC-G105514	55.50
LOADER TILT		2pc		P-UB-9	2-1/2	5	JIC-G105515	52.56
RIPPER		2pc		P-UB-9	2	4	JIC-G105526	40.35
		1pc		P-UB-10	2	4	JIC-1543273C1	47.24
MODEL 1450B, 1455B								
DOZER ANGLE		1pc		P-UB-10	2-1/4	4	JIC-G105556	43.45
DOZER LIFT		1pc		P-UB-10	2	4	JIC-1543273C1	47.24
DOZER TILT		2pc		P-UB-9	3	6	JIC-G105516	64.64
DOZER TILT & PITCH		2pc		P-UB-9	2-1/2	5	JIC-G105515	52.56
LOADER CLAM		2pc		P-UB-9	2-1/4	4-1/2	JIC-G105520	62.28
LOADER LIFT		2pc		P-UB-9	2-1/2	5-1/2	JIC-G105514	55.50
LOADER TILT		2pc		P-UB-9	2-1/2	5	JIC-G105515	52.56
RIPPER		1pc		P-UB-10	2	4	JIC-1543273C1	47.24
Uni-Loaders								
APPLICATION	CYL #	Piston	SERIAL #	CODE	ROD	BORE	KIT #	List \$
MODEL 1530B								
BUCKET		1pc		P-UB-10	1-1/2	3	JIC-G105502	32.46
BUCKET CLAM		1pc		P-UB-10	1-1/2	3	JIC-G105502	32.46
GRAPPLE		1pc		P-U-10	1	2	JIC-D61006	6.61
LIFT		1pc	9818251-UP	P-UB-10	1-1/2	2-1/2	JIC-G109458	20.07
		1pc	-->9818250	P-UB-10	1-1/2	3	JIC-G105502	32.46
SCARIFIER		1pc		P-UB-10	1-1/2	3	JIC-G105502	32.46
WOOD TICK		1pc		P-UB-10	1-1/2	3	JIC-G105502	32.46
MODEL 1700								
BUCKET		1pc		P-UB-10	1-1/2	3	JIC-G105502	32.46
BUCKET CLAM		1pc		P-UB-10	1-1/2	3	JIC-G105502	32.46
GRAPPLE		1pc		P-U-10	1	2	JIC-D61006	6.61
LIFT		1pc		P-UB-10	1-1/2	3	JIC-G105502	32.46
SCARIFIER		1pc		P-UB-10	1-1/2	3	JIC-G105502	32.46
WOOD TICK		1pc		P-UB-10	1-1/2	3	JIC-G105502	32.46
MODEL 1816B, 1816C								
BUCKET		1pc		P-U-10	1	2	JIC-D61006	6.61
GRAPPLE		1pc		P-U-10	1	2	JIC-D61006	6.61
LIFT		1pc		P-U-10	1	2	JIC-D61006	6.61



CASE

Replacement Kits For

Uni-Loaders								
APPLICATION	CYL #	Piston	SERIAL #	CODE	ROD	BORE	KIT #	List \$
MODEL 1818								
BUCKET TILT	D136128			P-U-10	1	2	JIC-N14638	29.07
LOADER LIFT	D136838			P-U-10	1-1/4	2	JIC-N14639	35.66
MODEL 1825								
BUCKET 4-IN-1	E99740			P-U-10	1	2	JIC-N14638	29.07
BUCKET TILT	D136128			P-U-10	1	2	JIC-N14638	29.07
LOADER LIFT	D136838			P-U-10	1-1/4	2	JIC-N14639	35.66
MODEL 1830								
BUCKET		1pc		P-U-10	1	2-1/2	JIC-G34807	14.11
		1pc		P-U-10	1	2-1/2	JIC-G35378	13.62
		1pc		P-U-10	1-1/4	2-1/8	JIC-G105507	22.57
GRAPPLE		1pc		P-U-10	1	2	JIC-D61006	6.61
LIFT		1pc		P-U-10	1-1/4	2-1/8	JIC-G34819	20.25
SCARIFIER		1pc		P-UB-10	1-1/2	3	JIC-G105502	32.46
MODEL 1835, 1835B								
BUCKET		1pc		P-UB-10	1-1/4	2-1/2	JIC-G109476	27.34
GRAPPLE		1pc		P-U-10	1	2	JIC-D61006	6.61
LIFT		1pc		P-UB-10	1-1/2	2-1/2	JIC-G109458	20.07
		1pc		P-U-10	1-1/4	2-1/8	JIC-G34819	20.25
MODEL 1840								
BUCKET TILT	118110A1			P-U-10	1-1/4	2-1/2	JIC-128728A1	20.62
	G103407			P-U-10	1-1/4	2-1/2	JIC-128728A1	20.62
GRAPPLE	D61075			P-U-10	1	2	JIC-D61006	6.61
LOADER LIFT	117824A1			P-UB-10	1-1/2	2-1/2	JIC-128725A1	24.36
	G110666	1pc		P-UB-10	1-1/2	2-1/2	JIC-G109458	20.07
MODEL 1845, 1845B, 1845C, 1845S								
BUCKET		1pc		P-UB-10	1-1/4	2-1/2	JIC-G109476	27.34
CLAM		1pc		P-UB-10	1-1/2	3	JIC-G109418	25.21
LIFT		1pc		P-UB-10	1-1/2	2-1/2	JIC-G109458	20.07
SCARIFIER		1pc		P-UB-10	1-1/2	3	JIC-G109418	25.21
Unimogs								
APPLICATION	CYL #	Piston	SERIAL #	CODE	ROD	BORE	KIT #	List \$
MODEL MB4/94 with Model 26C Backhoe, P80 Cable Plow, T70								
3-PT HITCH LIFT		2pc		P-UB-9	1-1/2	3	JIC-G105512	38.33
		1pc		P-UB-10	1-1/2	3	JIC-G105548	33.43
3-PT HITCH PITCH		1pc		P-U-10	1-1/4	2-1/8	JIC-G105507	22.57
BACKHOE BOOM		1pc		P-UB-10	2-1/4	4	JIC-G105556	43.45
		2pc		P-UB-9	2-1/2	4	JIC-G34636	44.02
BACKHOE BUCKET		1pc		P-UB-10	1-3/4	3	JIC-G105549	42.54
		2pc		P-UB-9	1-3/4	3	JIC-G105524	42.23
BACKHOE DIPPER		1pc		P-UB-10	2	3-1/2	JIC-G105546	37.63
		2pc		P-UB-9	2	3-1/2	JIC-G105527	42.05
BACKHOE DIPPER EXT		1pc		P-UB-10	1-1/2	3	JIC-G105548	33.43
		2pc		P-UB-9	1-1/2	3	JIC-G105512	38.33
BACKHOE STABILIZER		2pc		P-UB-9	1-3/4	3	JIC-G105524	42.23
		2pc		P-U-9	1-3/4	3-1/2	JIC-G105518	38.14
		1pc		P-UB-10	1-3/4	3	JIC-G105549	42.54

CASE



CASE

Replacement Kits For

Unimogs								
APPLICATION	CYL #	Piston	SERIAL #	CODE	ROD	BORE	KIT #	List \$
MODEL MB4/94 with Model 26C Backhoe, P80 Cable Plow, T70								
BACKHOE SWING		2pc		P-U-9	1-1/2	3-1/2	JIC-G34652	33.57
		1pc		P-UB-10	1-1/2	3-1/2	JIC-G105555	31.46
CABLE PLOW SHIFT		1pc		P-UB-10	1-1/2	2-1/2	JIC-G105550	25.09
FORKLIFT MAST TILT		1pc		P-UB-10	1-1/4	3	JIC-G105510	23.07
LIFT		2pc		P-UB-9	1-3/4	3	JIC-G105524	42.23
TILT		1pc		P-UB-10	1-1/2	3	JIC-G105502	32.46
		2pc		P-U-9	1-1/2	3-1/2	JIC-G34646	33.01
Wheel Loaders - 21-Series								
APPLICATION	CYL #	Piston	SERIAL #	CODE	ROD	BORE	KIT #	List \$
MODEL 621								
LOADER CLAM	S300146	1pc	-->JAK0021701	I-U-10	2	4	JIC-S300163	19.81
	S301479	1pc	JAK0021701-UP	I-U-10	2	4	JIC-S301442	30.11
LOADER LIFT	134596C1		JAK0021701-UP	P-UB-10	3	5	JIC-1543305C1	76.14
	G110354	1pc	JAK0021700-UP	P-UB-10	3	5	JIC-1543305C1	76.14
	G110355	1pc	-->JAK0021700	P-UB-10	3	5	JIC-1543305C1	76.14
LOADER TILT	1343552C2	1pc	JAK0020901-UP	P-UB-10	3	6	JIC-G110526	77.34
	1980354C1		JAK0020286- JAK0020900	P-UB-10	3	6	JIC-G110526	77.34
	G110312	1pc	-->JAK0020286	P-UB-10	3	6	JIC-G110526	77.34
STEERING	1976862C1	1pc	ALL	P-UB-10	1-3/4	3	JIC-G110049	32.94
MODEL 621B								
LOADER CLAM	S301431	1pc		I-U-10	2	4	JIC-S301442	30.11
LOADER LIFT	1343595C1			P-UB-10	3	5	JIC-1543305C1	76.14
	1343596C1	1pc		P-UB-10	3	5	JIC-1543305C1	76.14
LOADER TILT, XT LOADER	112551A1	1pc		P-UB-10	2-1/4	4-1/2	JIC-1543279C1	48.40
LOADER TILT, Z-BAR	1343552C2	1pc		P-UB-10	3	6	JIC-G110526	77.34
STEERING	1976862C1	1pc		P-UB-10	1-3/4	3	JIC-1543267C1	42.08
MODEL 621C								
LOADER LIFT	280706A1		ALL	P-UB-10	3	5	JIC-1543305C1	76.14
LOADER TILT	112551A1		ALL	P-UB-10	2-1/4	4-1/2	JIC-1543279C1	48.40
	125872A1		ALL	P-UB-10	3	6	JIC-1543306C1	91.82
	1343552C2		ALL	P-UB-10	3	6	JIC-1543306C1	91.82
STEERING	1976862C1		ALL	P-UB-10	1-3/4	3	JIC-1543267C1	42.08
MODEL 721								
LOADER CLAM	S300146	1pc		I-U-10	2	4	JIC-S300163	19.81
	S301431			I-U-10	2	4	JIC-S301442	30.11
	S301479	1pc		I-U-10	2	4	JIC-S301442	30.11
LOADER LIFT	1343595C1			P-UB-10	3	5	JIC-1543305C1	76.14
	1343596C1			P-UB-10	3	5	JIC-1543305C1	76.14
	G110354	1pc		P-UB-10	3	5	JIC-1543305C1	76.14
	G110355			P-UB-10	3	5	JIC-1543305C1	76.14
LOADER TILT	1345991C1	1pc	JAK0022102- JAK0022217	P-UB-10	3	6-1/2	JIC-1543303C1	127.60
	1980347C4	1pc	JAK002218-UP	P-UB-10	3	6-1/2	JIC-1543303C1	127.60
STEERING	1976862C1	1pc		P-UB-10	1-3/4	3	JIC-G110049	32.94



CASE

Replacement Kits For

Wheel Loaders - 21-Series								
APPLICATION	CYL #	Piston	SERIAL #	CODE	ROD	BORE	KIT #	List \$
MODEL 721B								
LOADER CLAM	S301431	1pc		I-U-10	2	4	JIC-S301442	30.11
LOADER LIFT	1343595C1	1pc		P-UB-10	3	5	JIC-1543305C1	76.14
	1343596C1	1pc		P-UB-10	3	5	JIC-1543305C1	76.14
LOADER TILT, XT LOADER	112551A1	1pc		P-UB-10	2-1/4	4-1/2	JIC-1543279C1	48.40
LOADER TILT, Z-BAR	1980347C4	1pc		P-UB-10	3	6-1/2	JIC-1543303C1	127.60
STEERING	1976862C1	1pc		P-UB-10	1-3/4	3	JIC-1543267C1	42.08
MODEL 721C								
LOADER LIFT	280706A1		ALL	P-UB-10	3	5	JIC-1543305C1	76.14
LOADER TILT	112551A1		ALL	P-UB-10	2-1/4	4-1/2	JIC-1543279C1	48.40
	125873A1		ALL	P-UB-10	3	6-1/2	JIC-1543303C1	127.60
	308986A1		ALL	P-UB-10	3	6-1/2	JIC-1543303C1	127.60
STEERING	1976862C1		ALL	P-UB-10	1-3/4	3	JIC-1543267C1	42.08
MODEL 821								
LOADER CLAM	S301000	1pc		I-U-10	2-1/2	5	JIC-S301013	47.24
LOADER LIFT	1340743C3	1pc		P-UB-10	3	6	JIC-G110526	77.34
	1986601C1	1pc		P-UB-10	3-1/2	6	JIC-1986823C2	127.33
LOADER TILT	1980385C3	1pc		P-UB-10	3-1/2	7	JIC-1543309C1	133.30
STEERING	1986978C1		JAK0024132-UP	P-UB-10	1-3/4	3-1/2	JIC-G110621	34.30
	1994558C1	1pc	JAK0024132	P-UB-10	1-3/4	3-1/2	JIC-G110621	34.30
MODEL 821B								
LOADER CLAM	S301000	1pc		I-U-10	2-1/2	5	JIC-S301013	47.24
LOADER LIFT	1986601C1	1pc		P-UB-10	3-1/2	6	JIC-1986823C2	127.33
LOADER TILT	1980386C3	1pc		P-UB-10	3-1/2	7	JIC-1543309C1	133.30
STEERING	1986978C1	1pc		P-UB-10	1-3/4	3-1/2	JIC-1543266C1	42.86
MODEL 821C								
LOADER LIFT	1986601C1		ALL	P-UB-10	3-1/2	6	JIC-1986823C2	127.33
LOADER TILT	190385C3		ALL	P-UB-10	3-1/2	7	JIC-1543309C1	133.30
STEERING	229402A1		ALL	P-UB-10	1-3/4	3-1/2	JIC-1543266C1	42.86
MODEL 921								
LOADER LIFT	1986603C1	1pc		P-UB-10	4	7	JIC-1986920C2	146.71
LOADER TILT	1346171C3	1pc		P-UB-10	4	8	JIC-1346357C2	191.36
STEERING	1346169C2	1pc	1346269C1 Gland	P-UB-10	2	4	JIC-1543269C1	43.21
	1346169C2	1pc	1346267C1 & 1346268C1	P-UB-10	2	4	JIC-1543269C1	43.21
MODEL 921C								
LOADER LIFT	1986603C1		ALL	P-UB-10	4	7	JIC-1986920C2	146.71
LOADER TILT	1346171C3		ALL	P-UB-10	4	8	JIC-1346357C2	191.36
STEERING	1346169C4		ALL	P-UB-10	2	4	JIC-1543269C1	43.21
Wheel Loaders - W-Series								
APPLICATION	CYL #	Piston	SERIAL #	CODE	ROD	BORE	KIT #	List \$
MODEL W3								
BACKHOE BOOM		2pc		N-N-9		4	JIC-G33239	17.54
				I-U-1	2		JIC-D42876	14.20
BACKHOE BUCKET				P-U-1	1-3/4		JIC-D42873	17.99
		2pc		N-N-9		3-1/2	JIC-G33237	16.09

CASE



CASE

Replacement Kits For

Wheel Loaders - W-Series								
APPLICATION	CYL #	Piston	SERIAL #	CODE	ROD	BORE	KIT #	List \$
MODEL W3								
BACKHOE DIPPER				I-U-1	2		JIC-D42876	14.20
		2pc		N-N-9		4	JIC-G33239	17.54
BACKHOE STABILIZER		2pc		N-N-9		3-1/2	JIC-G33237	16.09
				P-U-1	1-3/4		JIC-D42873	17.99
LOADER LIFT				P-U-1	1-1/2		JIC-D42870	17.52
		2pc		N-N-9		3	JIC-G33151	14.53
LOADER TILT				P-U-1	1-1/2		JIC-D42869	17.66
		2pc		N-N-9		2-1/2	JIC-G33193	14.17
MODEL W7, W7C, W7E								
BACKHOE BOOM		2pc		P-U-9	2	4	JIC-G32299	38.14
		2pc		N-N-9		3	JIC-G33151	14.53
				P-U-1	2-1/4		JIC-D42878	15.98
				I-U-1	2		JIC-D42876	14.20
		2pc		P-UB-9	2-1/4	4-1/2	JIC-G105520	62.28
		2pc		N-N-9		4-1/2	JIC-DTVS4.5P	34.76
BACKHOE BUCKET		2pc		P-U-9	2	3-1/2	JIC-G32293	34.48
		2pc		N-N-9		4	JIC-G33239	17.54
				I-U-1	2		JIC-D42874	11.82
		2pc		N-N-9		3-1/2	JIC-G33237	16.09
		2pc		P-UB-9	2-1/2	4	JIC-G34636	44.02
				I-U-1	2-1/4		JIC-D42877	13.02
BACKHOE DIPPER				P-U-1	1-3/4		JIC-D42873	17.99
		2pc		P-U-9	2	4	JIC-G32299	38.14
				I-U-1	2		JIC-D42876	14.20
				P-U-1	2-1/4		JIC-D42878	15.98
		2pc		N-N-9		4	JIC-G33239	17.54
		2pc		P-UB-9	2-1/4	4-1/2	JIC-G105520	62.28
BACKHOE STABILIZER		2pc		N-N-9		4-1/2	JIC-DTVS4.5P	34.76
		2pc		N-N-9		3-1/2	JIC-G33237	16.09
		2pc		N-N-9		4	JIC-G33239	17.54
				P-U-1	1-3/4		JIC-D42873	17.99
				I-U-1	2		JIC-D42876	14.20
		2pc		P-UB-9	1-3/4	3-1/2	JIC-G105529	35.77
BACKHOE SWING		2pc		P-U-9	1-3/4	3-1/2	JIC-G105518	38.14
		2pc		P-U-9	2	4	JIC-G32299	38.14
		2pc		P-U-1	1-3/4	4	JIC-G105519	36.58
		2pc		N-N-9		4	JIC-G33239	17.54
LOADER LIFT				P-UB-9	1-3/4	4	JIC-G105519	36.58
				I-U-1	2		JIC-D42876	14.20
LOADER TILT		2pc		P-U-9	2	4	JIC-G32299	38.14
		2pc		N-N-9		4	JIC-G33239	17.54
LOADER TILT		2pc		P-UB-9	1-1/2	3	JIC-G105512	38.33
MODEL W8E								
LOADER LIFT		2pc		P-U-9	2-1/2	5	JIC-G32184	44.99
LOADER TILT		2pc		P-U-9	1-3/4	3-1/2	JIC-G32228	34.04



CASE

Replacement Kits For

Wheel Loaders - W-Series								
APPLICATION	CYL #	Piston	SERIAL #	CODE	ROD	BORE	KIT #	List \$
MODEL W9, W9A, W9B, W9C, W9E, W10, W10B, W10C, W10E								
BACKHOE BOOM		2pc		N-N-9		4-1/2	JIC-DTVS4.5P	34.76
		2pc		P-U-9	2	4	JIC-G32299	38.14
				I-U-1	2		JIC-D42876	14.20
		2pc		P-UB-9	2-1/4	4-1/2	JIC-G105520	62.28
				P-U-1	2-1/4		JIC-D42878	15.98
		2pc		N-N-9		4	JIC-G33239	17.54
BACKHOE BUCKET				I-U-1	2-1/4		JIC-D42877	13.02
		2pc		N-N-9		3-1/2	JIC-G33237	16.09
				P-U-1	1-3/4		JIC-D42873	17.99
		2pc		N-N-9		4	JIC-G33239	17.54
		2pc		P-U-9	2	3-1/2	JIC-G32293	34.48
		2pc		I-U-1	2		JIC-D42874	11.82
BACKHOE DIPPER				P-UB-9	2-1/2	4	JIC-G34636	44.02
				P-U-1	2-1/4		JIC-D42878	15.98
		2pc		N-N-9		4-1/2	JIC-DTVS4.5P	34.76
		2pc		P-UB-9	2-1/4	4-1/2	JIC-G105520	62.28
		2pc		P-U-9	2	4	JIC-G32299	38.14
				I-U-1	2		JIC-D42876	14.20
BACKHOE STABILIZER		2pc		N-N-9		4	JIC-G33239	17.54
				P-U-1	1-3/4		JIC-D42873	17.99
		2pc		N-N-9		3-1/2	JIC-G33237	16.09
		2pc		N-N-9		4	JIC-G33239	17.54
		2pc		P-U-9	1-3/4	3-1/2	JIC-G105518	38.14
				I-U-1	2		JIC-D42876	14.20
BACKHOE SWING		2pc		P-UB-9	1-3/4	3-1/2	JIC-G105529	35.77
		2pc		P-U-9	2	4	JIC-G32299	38.14
	BACKHOE SWING	2pc		P-UB-9	1-3/4	4	JIC-G105519	36.58
				P-U-1	1-3/4		JIC-D42875	13.93
		2pc		N-N-9		4	JIC-G33239	17.54
	LOADER LIFT		2pc		P-U-9	2-1/2	5	JIC-G32184
LOADER TILT		2pc		P-U-9	1-3/4	3-1/2	JIC-G32228	34.04
MODEL W11, W11B								
LOADER CLAM		1pc		P-UB-10	1-3/4	3	JIC-1543262C1	34.76
LOADER LIFT		1pc		P-UB-10	2	3-1/2	JIC-G109453	37.63
LOADER TILT		1pc		P-UB-10	1-1/2	2-1/2	JIC-1543253C1	36.88
STEERING		1pc		P-UB-10	1-1/2	3	JIC-G109452	25.39
MODEL W14, W14L, W14H								
BACKHOE BOOM		1pc		P-UB-10	1-3/4	3-1/4	JIC-1543265C1	43.07
		1pc		P-UB-10	2-1/4	4	JIC-G109505	39.90
		2pc		P-UB-9	1-3/4	3-1/4	JIC-G105528	36.68
		2pc		P-UB-9	2-1/2	4	JIC-G34636	44.02
BACKHOE BUCKET		2pc		P-UB-9	2	3-1/2	JIC-G109454	27.94
		2pc		P-UB-9	1-3/4	3	JIC-G109462	29.11
		2pc		P-UB-10	1-1/2	3	JIC-G109452	25.39
		1pc		P-UB-10	2-1/2	4	JIC-G109424	43.95
		1pc		P-UB-10	2-1/2	3-1/2	JIC-G109504	37.16

CASE



CASE

Replacement Kits For

Wheel Loaders - W-Series								
APPLICATION	CYL #	Piston	SERIAL #	CODE	ROD	BORE	KIT #	List \$
MODEL W14, W14L, W14H								
BACKHOE BUCKET		1pc		P-UB-10	1-3/4	3	JIC-1543262C1	34.76
		1pc		P-UB-10	2	3-1/2	JIC-G109453	37.63
BACKHOE DIPPER		2pc		P-UB-9	2	4	JIC-G109421	29.43
		1pc		P-UB-10	2	4	JIC-1543273C1	47.24
		2pc		P-UB-9	2	3-1/2	JIC-G109454	27.94
		1pc		P-UB-10	2	3-1/2	JIC-G109453	37.63
BACKHOE DIPPER EXT		1pc		P-UB-10	1-1/2	3	JIC-G109452	25.39
		2pc		P-UB-9	1-1/2	3	JIC-G105512	38.33
BACKHOE STABILIZER		2pc		P-UB-9	1-3/4	3-1/2	JIC-G109470	32.97
		1pc		P-UB-10	2	4	JIC-1543273C1	47.24
		2pc		P-UB-9	2	4	JIC-G109421	29.43
		1pc		P-UB-10	1-3/4	3-1/2	JIC-G109471	36.68
BACKHOE SWING		2pc		P-U-9	1-1/2	3-1/2	JIC-G34652	33.57
		2pc		P-UB-9	2	4	JIC-G109421	29.43
		1pc		P-UB-10	2	4	JIC-1543273C1	47.24
		1pc		P-UB-10	1-1/2	3-1/2	JIC-G109472	34.68
LOADER CLAM		2pc		P-UB-9	1-1/2	3	JIC-G105512	38.33
		1pc		P-UB-10	1-1/2	3	JIC-G109452	25.39
LOADER GRAPPLE		1pc		P-UB-10	1-1/2	3	JIC-G109418	25.21
LOADER LIFT		2pc		P-UB-9	2-1/4	4-1/2	JIC-G105520	62.28
LOADER TILT		1pc		P-UB-10	1-3/4	3	JIC-1543262C1	34.76
		2pc		P-UB-9	1-3/4	3	JIC-G109462	29.11
STEERING		2pc		P-U-9	1-1/4	2-1/2	JIC-G32295	31.87
		1pc		P-UB-10	1-1/4	2-1/2	JIC-G109475	28.43
MODEL W14B								
LOADER CLAM		1pc		P-UB-10	1-1/2	3	JIC-G109452	25.39
LOADER GRAPPLE		1pc		P-UB-10	1-1/2	3	JIC-G109418	25.21
LOADER LIFT		2pc		P-UB-9	2-1/4	4-1/2	JIC-G105520	62.28
LOADER TILT		1pc		P-UB-10	2	3-1/2	JIC-G109453	37.63
STEERING		1pc		P-UB-10	1-1/4	2-1/2	JIC-G109475	28.43
MODEL W18, W20, W20B								
LOADER CLAM		2pc		P-U-9	2	4	JIC-G32299	38.14
		1pc		P-UB-10	2	4	JIC-1543273C1	47.24
LOADER LIFT		2pc	-->9115602	P-U-9	3	5	JIC-G32668	52.00
		2pc	9123140-UP	P-UB-9	2-1/2	5	JIC-G105515	52.56
		2pc	9115603-9123139	P-U-9	3	5	JIC-G109502	59.33
LOADER TILT		2pc		P-UB-9	2	4	JIC-G109421	29.43
		1pc		P-UB-10	2	4	JIC-1543273C1	47.24
STEERING		1pc		P-UB-10	1-1/2	3	JIC-G109452	25.39
		2pc		P-UB-9	1-1/2	3	JIC-G105512	38.33
MODEL W18B, W20C								
LOADER LIFT		2pc	ALL	P-UB-9	2-1/2	5	JIC-G105515	52.56
LOADER TILT		1pc		P-UB-10	2	4	JIC-1543273C1	47.24
STEERING		1pc		P-UB-10	1-1/2	3	JIC-G109452	25.39
MODEL W24								
LOADER CLAM		2pc		N-N-9		4	JIC-G33239	17.54



CASE

Replacement Kits For

Wheel Loaders - W-Series								
APPLICATION	CYL #	Piston	SERIAL #	CODE	ROD	BORE	KIT #	List \$
MODEL W24								
LOADER CLAM		2pc		P-U-9	2	4	JIC-G32299	38.14
				I-U-1	2		JIC-D42876	14.20
LOADER LIFT		2pc		P-U-9	3	5	JIC-G32668	52.00
LOADER TILT		2pc		P-UB-9	2-1/2	4-1/2	JIC-G105513	64.23
STEERING		2pc	9105109-UP	P-UB-9	1-1/2	3	JIC-G105512	38.33
		2pc		N-N-9		3	JIC-G33151	14.53
			-->9105108	P-U-1	1-1/2		JIC-D42870	17.52
MODEL W24B								
LOADER CLAM		1pc		P-UB-10	2	4	JIC-1543273C1	47.24
		2pc		P-U-9	2	4	JIC-G32299	38.14
		2pc		P-U-9	2	4	JIC-G34335	35.95
LOADER LIFT		2pc		P-U-9	3	5	JIC-G34334	64.11
		2pc		P-U-9	3	5	JIC-G32668	52.00
		2pc		P-UB-9	3	5	JIC-G105531	60.15
LOADER TILT		2pc		P-UB-9	2-1/2	4-1/2	JIC-G105513	64.23
STEERING		1pc		P-UB-10	1-1/2	3	JIC-G105548	33.43
		2pc		P-UB-9	1-1/2	3	JIC-G105512	38.33
MODEL W24C								
LOADER CLAM		1pc		P-UB-10	2	4	JIC-1543273C1	47.24
LOADER LIFT		2pc		P-UB-9	3	5	JIC-G105531	60.15
LOADER TILT		2pc		P-UB-9	2-1/2	4-1/2	JIC-G105513	64.23
STEERING		1pc		P-UB-10	1-1/2	3	JIC-G105548	33.43
MODEL W26B, W26FL								
LOADER LIFT		2pc	9107499-UP	P-UB-9	3	6	JIC-G105516	64.64
LOADER TILT		2pc		P-U-9	2-1/2	5	JIC-G32184	44.99
		2pc		P-UB-9	2-1/2	5	JIC-G105515	52.56
STEERING		2pc		P-UB-9	2	3-1/2	JIC-G105527	42.05
				I-U-1	2		JIC-D42874	11.82
		2pc		P-U-9	2	3-1/2	JIC-G32293	34.48
		2pc		N-N-9		3-1/2	JIC-G33237	16.09
MODEL W30								
LOADER CLAM		1pc		P-UB-10	2	4	JIC-1543273C1	47.24
LOADER TILT		2pc		P-UB-9	2-1/4	4-1/2	JIC-G105520	62.28
STEERING		1pc		P-UB-10	1-3/4	3-1/4	JIC-G105547	38.44
MODEL W36								
LOADER LIFT		2pc		P-UB-9	3	6	JIC-G105516	64.64
LOADER TILT		2pc		P-UB-9	2-1/4	4-1/2	JIC-G105520	62.28
STEERING		2pc		P-UB-9	2	4	JIC-G105517	38.79
		1pc		P-UB-10	2	4	JIC-1543273C1	47.24
Wheeled Backhoe Loaders								
APPLICATION	CYL #	Piston	SERIAL #	CODE	ROD	BORE	KIT #	List \$
MODEL 380LL								
LIFT		2pc		P-U-9	1-1/2	2-1/2	JIC-G32294	26.40
TILT		2pc		P-U-9	1-1/2	2-1/2	JIC-G32294	26.40
MODEL 430 with Backhoe Models 21, 22, 23								
BACKHOE BOOM				P-U-1	1-3/4		JIC-D42873	17.99

CASE



CASE

Replacement Kits For

Wheeled Backhoe Loaders								
APPLICATION	CYL #	Piston	SERIAL #	CODE	ROD	BORE	KIT #	List \$
MODEL 430 with Backhoe Models 21, 22, 23								
BACKHOE BOOM		2pc		N-N-9		3	JIC-G33151	14.53
				P-U-1	1-3/4		JIC-D42872	13.12
		2pc		N-N-9		3-1/2	JIC-G33237	16.09
BACKHOE BUCKET				I-U-1	2		JIC-D42874	11.82
		2pc		N-N-9		3	JIC-G33151	14.53
BACKHOE DIPPER				I-U-1	2		JIC-D42874	11.82
		2pc		N-N-9		3-1/2	JIC-G33237	16.09
		2pc		N-N-9		3	JIC-G33151	14.53
BACKHOE STABILIZER		2pc		N-N-9		2-1/2	JIC-G33193	14.17
				P-U-1	1-1/4		JIC-D42867	14.05
BACKHOE SWING				P-U-1	1-1/4		JIC-D42867	14.05
		2pc		N-N-9		2-1/2	JIC-G33193	14.17
LOADER LIFT				P-U-1	1-1/2		JIC-D42869	17.66
		2pc		N-N-9		2-1/2	JIC-G33193	14.17
LOADER TILT		2pc		N-N-9		3	JIC-G33151	14.53
				P-U-1	1-1/2		JIC-D42870	17.52
MODEL 480, 480B with Backhoe Models 23, 26, 26B, 26S								
3-PT HITCH LIFT		2pc		P-UB-9	1-1/2	3	JIC-G105512	38.33
3-PT HITCH PITCH		2pc		P-U-9	1-1/4	2-1/2	JIC-G32295	31.87
		1pc		P-U-10	1-1/4	2-1/8	JIC-G105507	22.57
3-PT HITCH TILT		2pc		P-U-9	1-1/4	2-1/2	JIC-G32295	31.87
BACKHOE BOOM				P-U-1	1-3/4		JIC-D42873	17.99
		2pc		P-UB-9	2-1/2	4	JIC-G34636	44.02
		2pc		N-N-9		3-1/2	JIC-G33237	16.09
		2pc		P-UB-9	1-3/4	3-1/2	JIC-G105529	35.77
BACKHOE BUCKET				P-U-1	1-3/4		JIC-D42872	13.12
				P-U-1	1-1/2		JIC-D42870	17.52
		2pc		N-N-9		3	JIC-G33151	14.53
		2pc		P-UB-9	1-3/4	3	JIC-G105524	42.23
BACKHOE DIPPER		2pc		P-UB-9	2	3-1/2	JIC-G105527	42.05
				I-U-1	2		JIC-D42874	11.82
		2pc		N-N-9		3-1/2	JIC-G33237	16.09
		2pc		P-U-9	2	3-1/2	JIC-G32293	34.48
BACKHOE DIPPER EXT		2pc		P-UB-9	1-1/2	3	JIC-G105512	38.33
BACKHOE STABILIZER				P-U-1	1-3/4		JIC-D42872	13.12
		2pc		P-UB-9	1-3/4	3-1/2	JIC-G105529	35.77
				P-U-1	1-1/4		JIC-D42867	14.05
		2pc		P-UB-9	1-3/4	3	JIC-G105524	42.23
				P-U-1	1-1/2		JIC-D42870	17.52
		2pc		N-N-9		2-1/2	JIC-G33193	14.17
		2pc		N-N-9		3	JIC-G33151	14.53
		2pc		P-U-9	1-3/4	3-1/2	JIC-G105518	38.14
BACKHOE SWING				P-U-1	1-1/4		JIC-D42867	14.05
		2pc		N-N-9		3-1/2	JIC-G33237	16.09
				P-U-1	1-1/2		JIC-D47896	14.14
		2pc		P-U-9	1-1/2	3-1/2	JIC-G34652	33.57

NORTH AMERICA
 PHONE 1-800-777-5617
 FAX 1-800-759-6391

SALES OFFICE HOURS
 8 A.M. TO 8 P.M. EASTERN TIME
 www.HerculesUS.com

WORLDWIDE
 PHONE 1-727-796-1300
 FAX 1-727-797-8849



CASE

Replacement Kits For

Wheeled Backhoe Loaders								
APPLICATION	CYL #	Piston	SERIAL #	CODE	ROD	BORE	KIT #	List \$
MODEL 480, 480B with Backhoe Models 23, 26, 26B, 26S								
BACKHOE SWING		2pc		N-N-9		2-1/2	JIC-G33193	14.17
		2pc		P-UB-9	1-3/4	4	JIC-G105519	36.58
LOADER LIFT		2pc		N-N-9		2-1/2	JIC-G33193	14.17
				P-U-1	1-1/2		JIC-D42869	17.66
		2pc		P-U-9	1-1/2	2-1/2	JIC-G32294	26.40
LOADER TILT		2pc		P-U-9	1-1/2	2-1/2	JIC-G32294	26.40
		2pc		N-N-9		3	JIC-G33151	14.53
				P-U-1	1-1/2		JIC-D42870	17.52
		2pc		P-UB-9	1-1/2	3	JIC-G105512	38.33
STEERING		1pc	87357171-UP	I-O-3	3/4	1-1/2	JIC-A44644	8.89
MODEL 480C								
3-PT HITCH LIFT		1pc		P-UB-10	1-1/2	3	JIC-G109452	25.39
		2pc		P-UB-9	1-1/2	3	JIC-G105512	38.33
3-PT HITCH PITCH		1pc		P-UB-10	1-1/4	2-1/2	JIC-G109476	27.34
3-PT HITCH TILT		2pc		P-U-9	1-1/4	2-1/2	JIC-G32295	31.87
		1pc		P-UB-10	1-1/4	2-1/2	JIC-G109475	28.43
BACKHOE BOOM		2pc		P-UB-9	2-1/2	4	JIC-G34636	44.02
		1pc		P-UB-10	2-1/4	4	JIC-G109505	39.90
BACKHOE BUCKET		2pc		P-UB-9	1-3/4	3	JIC-G109462	29.11
		1pc		P-UB-10	1-3/4	3	JIC-1543262C1	34.76
BACKHOE DIPPER		2pc		P-UB-9	2	3-1/2	JIC-G109454	27.94
		1pc		P-UB-10	2	3-1/2	JIC-G109453	37.63
BACKHOE DIPPER EXT		1pc		P-UB-10	1-1/2	3	JIC-G109452	25.39
		2pc		P-UB-9	1-1/2	3	JIC-G105512	38.33
BACKHOE STABILIZER		2pc		P-UB-9	1-3/4	3	JIC-G109462	29.11
		2pc		P-UB-9	1-3/4	3-1/2	JIC-G109470	32.97
		1pc		P-UB-10	1-3/4	3-1/2	JIC-G109471	36.68
		1pc		P-UB-10	1-3/4	3	JIC-1543262C1	34.76
BACKHOE SWING				P-U-9	1-1/2	3-1/2	JIC-G34652	33.57
		1pc		P-UB-10	1-1/2	3-1/2	JIC-G109472	34.68
LOADER LIFT		1pc		P-UB-10	1-1/2	2-1/2	JIC-1543253C1	36.88
		2pc		P-UB-9	1-1/2	2-1/2	JIC-G109484	30.69
LOADER TILT		2pc		P-UB-9	1-1/2	2-1/2	JIC-G109484	30.69
		1pc		P-UB-10	1-1/2	2-1/2	JIC-1543253C1	36.88
STEERING		1pc	-->8980833	I-O-3	3/4	1-1/2	JIC-A44644	8.89
		1pc	8980834-UP	I-U-10	3/4	1-1/2	JIC-D148100	13.38
MODEL 480D, 480D LL								
3-PT HITCH LIFT		1pc		P-UB-10	1-1/2	3	JIC-G109452	25.39
3-PT HITCH PITCH		1pc		P-UB-10	1-1/4	2-1/2	JIC-G109476	27.34
3-PT HITCH TILT		1pc		P-UB-10	1-1/4	2-1/2	JIC-G109475	28.43
BACKHOE BUCKET		1pc		P-UB-10	2	3-1/4	JIC-G109465	39.86
		1pc		P-UB-10	2-1/2	3-1/2	JIC-G109504	37.16
BACKHOE DIPPER		1pc		P-UB-10	2	3-1/2	JIC-G109453	37.63
BACKHOE DIPPER EXT		1pc		P-UB-10	1-1/2	3	JIC-G109452	25.39
BACKHOE STABILIZER		1pc		P-UB-10	1-3/4	3	JIC-1543262C1	34.76
		1pc		P-UB-10	1-3/4	3-1/2	JIC-G109471	36.68

CASE



CASE

Replacement Kits For

Wheeled Backhoe Loaders								
APPLICATION	CYL #	Piston	SERIAL #	CODE	ROD	BORE	KIT #	List \$
MODEL 480D, 480D LL								
BACKHOE SWING		1pc		P-UB-10	1-1/2	3-1/2	JIC-G109472	34.68
LOADER LIFT		1pc		P-UB-10	1-1/2	2-1/2	JIC-1543253C1	36.88
LOADER TILT		1pc		P-UB-10	1-1/2	2-1/2	JIC-1543253C1	36.88
STEERING		1pc	ALL	I-U-10	3/4	1-1/2	JIC-D148100	13.38
MODEL 480E, 480E LL								
3-PT HITCH LIFT		1pc		P-UB-10	1-1/2	3	JIC-G109452	25.39
3-PT HITCH PITCH		1pc		P-UB-10	1-1/4	2-1/2	JIC-G109476	27.34
3-PT HITCH TILT		1pc		P-UB-10	1-1/4	2-1/2	JIC-G109475	28.43
BACKHOE BUCKET		1pc		P-UB-10	2	3-1/4	JIC-G109465	39.86
BACKHOE DIPPER		1pc		P-UB-10	2	3-1/2	JIC-G109453	37.63
BACKHOE DIPPER EXT		1pc		P-UB-10	1-1/2	3	JIC-G109452	25.39
BACKHOE STABILIZER		1pc		P-UB-10	1-3/4	3-1/2	JIC-G109471	36.68
BACKHOE SWING				P-UB-10	1-1/2	3-1/2	JIC-G109472	34.68
LOADER LIFT		1pc		P-UB-10	1-1/2	2-1/2	JIC-1543253C1	36.88
LOADER TILT		1pc		P-UB-10	1-1/2	2-1/2	JIC-1543253C1	36.88
STEERING		1pc	ALL	I-U-10	3/4	1-1/2	JIC-D148100	13.38
MODEL 480F, 480F LL								
3-PT HITCH LIFT	G101188	1pc		P-UB-10	1-1/4	2-1/2	JIC-1543250C1	31.43
	G101189	1pc		P-UB-10	1-1/2	3	JIC-1543252C1	36.15
3-PT HITCH PITCH	1976884C1	1pc		P-UB-10	1-1/4	2-1/2	JIC-1543249C1	39.53
BACKHOE BOOM	G102835	1pc		P-UB-10	1-3/4	4	JIC-1543264C1	43.79
BACKHOE BUCKET	G109342	1pc		P-UB-10	2-1/2	3-1/2	JIC-1543294C1	39.59
BACKHOE STAB. 480F	1340827C1	1pc		P-UB-10	1-3/4	3-1/2	JIC-1543266C1	42.86
BACKHOE SWING	G110395	1pc		P-UB-10	1-1/2	3-1/2	JIC-1543254C1	39.58
BUCKET 480F ONLY	G103503	1pc		P-UB-10	2	3-1/4	JIC-1543268C1	40.29
DIPPER (12ft)	G104844	1pc		P-UB-10	2	3-1/2	JIC-1543274C1	48.24
DIPPER (14ft)	1980159C1	1pc		P-UB-10	2	3-3/4	JIC-1980181C2	49.21
DIPPER EXT. 480F only	G101203	1pc		P-UB-10	1-1/2	3	JIC-1543252C1	36.15
LOADER BUCKET	G101186	1pc		P-UB-10	1-1/2	2-1/2	JIC-1543253C1	36.88
LOADER CLAM	1346189C1	1pc		P-UB-10	1-3/4	3	JIC-1543267C1	42.08
	G101190	1pc		P-UB-10	1-3/4	3	JIC-1543262C1	34.76
LOADER LIFT	1340792C1	1pc		P-UB-10	1-3/4	3	JIC-1543267C1	42.08
MODEL 530 with Backhoe Models 31, 32, 32S								
BACKHOE BOOM		2pc		N-N-9		4	JIC-G33239	17.54
		2pc		P-U-9	2	4	JIC-G32616	35.21
				I-U-1	2		JIC-D42876	14.20
BACKHOE BUCKET		2pc		P-U-9	1-3/4	3-1/2	JIC-G105518	38.14
				P-U-1	1-3/4		JIC-D42873	17.99
		2pc		N-N-9		3-1/2	JIC-G33237	16.09
BACKHOE DIPPER		2pc		N-N-9		4	JIC-G33239	17.54
				I-U-1	2		JIC-D42876	14.20
		2pc		P-UB-9	2	4	JIC-G105526	40.35
BACKHOE STABILIZER		2pc		P-UB-9	1-3/4	3-1/2	JIC-G105529	35.77
				P-U-1	1-3/4		JIC-D42873	17.99
		2pc		N-N-9		3-1/2	JIC-G33237	16.09
		2pc		P-U-9	1-3/4	3-1/2	JIC-G105518	38.14



CASE

Replacement Kits For

Wheeled Backhoe Loaders								
APPLICATION	CYL #	Piston	SERIAL #	CODE	ROD	BORE	KIT #	List \$
MODEL 530 with Backhoe Models 31, 32, 32S								
BACKHOE SWING				P-U-1	1-3/4		JIC-D42875	13.93
		2pc		P-U-9	1-3/4	4	JIC-G32617	36.68
		2pc		N-N-9		4	JIC-G33239	17.54
LOADER HYDRA-LEVELING				P-U-1	1-3/4		JIC-D42872	13.12
		2pc		N-N-9		3	JIC-G33151	14.53
LOADER LIFT				P-U-1	1-1/2		JIC-D42869	17.66
				P-U-1	1-1/2		JIC-D42870	17.52
		2pc		N-N-9		2-1/2	JIC-G33193	14.17
		2pc		N-N-9		3	JIC-G33151	14.53
LOADER TILT				P-U-1	1-1/4		JIC-D42867	14.05
				P-U-1	1-1/2		JIC-D42869	17.66
		2pc		N-N-9		2-1/2	JIC-G33193	14.17
MODEL 580 with Backhoe Models 33, 33S								
3-PT HITCH LIFT		2pc		P-U-9	1-1/2	2-1/2	JIC-G32294	26.40
3-PT HITCH PITCH		1pc		P-U-10	1-1/4	2-1/8	JIC-G105507	22.57
		2pc		P-U-9	1-1/4	2-1/2	JIC-G32295	31.87
3-PT HITCH TILT		2pc		P-UB-9	1-1/2	3	JIC-G105512	38.33
BACKHOE BOOM		2pc		P-U-9	2	4	JIC-G32299	38.14
		2pc		N-N-9		4	JIC-G33239	17.54
		2pc		P-UB-9	2	4	JIC-G105517	38.79
				I-U-1	2		JIC-D42876	14.20
		1pc		P-UB-9	2-1/4	4-1/2	JIC-G105520	62.28
				P-U-1	2-1/4		JIC-D42878	15.98
		2pc		N-N-9		4-1/2	JIC-DTVS4.5P	34.76
		2pc		P-UB-9	2	3-1/2	JIC-G105527	42.05
BACKHOE BUCKET		2pc		I-U-1	2		JIC-D42874	11.82
				P-U-1	2-1/4		JIC-D42878	15.98
		2pc		P-U-1	1-3/4		JIC-D42873	17.99
		2pc		N-N-9		3-1/2	JIC-G33237	16.09
		2pc		P-U-9	2	3-1/2	JIC-G32293	34.48
		2pc		P-UB-9	2	4	JIC-G105517	38.79
BACKHOE DIPPER		2pc		I-U-1	2		JIC-D42876	14.20
		2pc		P-U-9	2	4	JIC-G32299	38.14
		2pc		N-N-9		4	JIC-G33239	17.54
		2pc		P-UB-9	1-1/2	3	JIC-G105512	38.33
BACKHOE DIPPER EXT		2pc		P-UB-9	1-3/4	3-1/2	JIC-G105529	35.77
				P-U-1	1-3/4		JIC-D42873	17.99
		2pc		N-N-9		3-1/2	JIC-G33237	16.09
				P-U-1	1-3/4		JIC-D42873	17.99
BACKHOE STABILIZER				P-U-1	1-3/4		JIC-D42873	17.99
		2pc		P-U-9	1-3/4	3-1/2	JIC-G105518	38.14
		2pc		N-N-9		3-1/2	JIC-G33237	16.09
		2pc		P-UB-9	1-3/4	3-1/2	JIC-G105529	35.77
BACKHOE SWING		2pc		P-UB-9	1-3/4	4	JIC-G105519	36.58
		2pc		N-N-9		4	JIC-G33239	17.54
				P-U-1	1-3/4		JIC-D42875	13.93

CASE



CASE

Replacement Kits For

Wheeled Backhoe Loaders								
APPLICATION	CYL #	Piston	SERIAL #	CODE	ROD	BORE	KIT #	List \$
MODEL 580 with Backhoe Models 33, 33S								
LOADER CLAM		2pc		P-UB-9	1-3/4	3	JIC-G105524	42.23
LOADER GRAPPLE		2pc		N-N-9		2-1/2	JIC-G33193	14.17
		2pc		P-U-9	1-1/2	2-1/2	JIC-G32294	26.40
				P-U-1	1-1/2		JIC-D42869	17.66
LOADER HYDRA-LEVELING		2pc		P-UB-9	1-3/4	3	JIC-G105524	42.23
		2pc		N-N-9		3	JIC-G33151	14.53
				P-U-1	1-3/4		JIC-D42872	13.12
LOADER LIFT		2pc		N-N-9		3	JIC-G33151	14.53
		2pc		P-UB-9	1-1/2	3	JIC-G105512	38.33
				P-U-1	1-1/2		JIC-D42870	17.52
LOADER TILT		2pc		N-N-9		2-1/2	JIC-G33193	14.17
				P-U-1	1-1/2		JIC-D42869	17.66
		2pc		P-U-9	1-1/2	2-1/2	JIC-G32294	26.40
MODEL 580B with Backhoe Model 35								
3-PT HITCH LIFT		2pc		P-UB-9	1-1/2	3	JIC-G105512	38.33
		1pc		P-UB-10	1-1/2	3	JIC-G105548	33.43
3-PT HITCH PITCH		2pc		P-U-9	1-1/4	2-1/2	JIC-G32295	31.87
		1pc		P-U-10	1-1/4	2-1/8	JIC-G105507	22.57
3-PT HITCH TILT		2pc		P-U-9	1-1/4	2-1/2	JIC-G32295	31.87
		1pc		P-UB-10	1-1/4	2-1/2	JIC-G105551	28.43
BACKHOE BOOM		1pc		P-UB-10	1-3/4	3-1/4	JIC-G105547	38.44
		2pc		P-UB-9	1-3/4	3-1/4	JIC-G105528	36.68
BACKHOE BUCKET		2pc		P-UB-9	2	3-1/2	JIC-G105527	42.05
		1pc		P-UB-10	2	3-1/2	JIC-G105546	37.63
BACKHOE DIPPER		2pc		P-UB-9	2	4	JIC-G105517	38.79
		1pc		P-UB-10	2	4	JIC-1543273C1	47.24
BACKHOE DIPPER EXT		1pc		P-UB-10	1-1/2	3	JIC-G105548	33.43
		2pc		P-UB-9	1-1/2	3	JIC-G105512	38.33
BACKHOE STABILIZER		2pc		P-UB-9	1-3/4	3-1/2	JIC-G105529	35.77
		2pc		P-UB-9	2	4	JIC-G105517	38.79
		2pc		P-UB-9	2	3-1/2	JIC-G105527	42.05
		1pc		P-UB-10	2	4	JIC-1543273C1	47.24
BACKHOE SWING		2pc		P-UB-9	2	4	JIC-G105517	38.79
		1pc		P-UB-10	2	4	JIC-1543273C1	47.24
LOADER CLAM		2pc		P-UB-9	1-3/4	3	JIC-G105524	42.23
		1pc		P-UB-10	1-3/4	3	JIC-G105549	42.54
LOADER HYDRA-LEVELING		2pc		P-UB-9	1-3/4	3	JIC-G105524	42.23
		1pc		P-UB-10	1-3/4	3	JIC-G105549	42.54
LOADER LIFT		2pc		P-UB-9	1-1/2	3	JIC-G105512	38.33
		1pc		P-UB-10	1-1/2	3	JIC-G105548	33.43
LOADER TILT		1pc		P-UB-10	1-1/2	2-1/2	JIC-G105550	25.09
		2pc		P-U-9	1-1/2	2-1/2	JIC-G32294	26.40
LOGGING FORK GRAPPLE		1pc		P-UB-10	1-1/2	2-1/2	JIC-G105550	25.09
		2pc		P-U-9	1-1/2	2-1/2	JIC-G32294	26.40



CASE

Replacement Kits For

Wheeled Backhoe Loaders								
APPLICATION	CYL #	Piston	SERIAL #	CODE	ROD	BORE	KIT #	List \$
MODEL 580B with Backhoe Model 35								
STEERING		1pc		I-O-3	3/4	1-1/2	JIC-A44644	8.89
MODEL 580C								
3-PT HITCH LIFT		1pc		P-UB-10	1-1/2	3	JIC-G109452	25.39
		2pc		P-UB-9	1-1/2	3	JIC-G105512	38.33
3-PT HITCH PITCH		1pc		P-UB-10	1-1/4	2-1/2	JIC-G109476	27.34
3-PT HITCH TILT		2pc		P-U-9	1-1/4	2-1/2	JIC-G32295	31.87
		1pc		P-UB-10	1-1/4	2-1/2	JIC-G109475	28.43
BACKHOE BOOM		2pc		P-UB-9	1-3/4	3-1/4	JIC-G105528	36.68
		1pc		P-UB-10	1-3/4	3-1/4	JIC-1543265C1	43.07
BACKHOE BUCKET		2pc		P-UB-9	2	3-1/2	JIC-G109454	27.94
		1pc		P-UB-10	2	3-1/2	JIC-G109453	37.63
BACKHOE DIPPER		1pc		P-UB-10	2	4	JIC-1543273C1	47.24
		2pc		P-UB-9	2	4	JIC-G109421	29.43
BACKHOE DIPPER EXT		1pc		P-UB-10	1-1/2	3	JIC-G109452	25.39
		2pc		P-UB-9	1-1/2	3	JIC-G105512	38.33
BACKHOE STABILIZER		2pc		P-UB-9	2	4	JIC-G109421	29.43
		1pc		P-UB-10	2	4	JIC-1543273C1	47.24
BACKHOE SWING		2pc		P-UB-9	2	4	JIC-G109421	29.43
		1pc		P-UB-10	2	4	JIC-1543273C1	47.24
LOADER CLAM		1pc		P-UB-10	1-3/4	3	JIC-1543262C1	34.76
		2pc		P-UB-9	1-3/4	3	JIC-G109462	29.11
LOADER GRAPPLE		2pc		P-UB-9	1-1/2	2-1/2	JIC-G109484	30.69
		1pc		P-UB-10	1-1/2	2-1/2	JIC-1543253C1	36.88
LOADER LIFT		2pc		P-UB-9	1-3/4	3	JIC-G109462	29.11
		1pc		P-UB-10	1-3/4	3	JIC-1543262C1	34.76
LOADER TILT		2pc		P-UB-9	1-1/2	2-1/2	JIC-G109484	30.69
		1pc		P-UB-10	1-1/2	2-1/2	JIC-1543253C1	36.88
STEERING		1pc	8983288-UP	I-U-10	3/4	1-1/2	JIC-D148100	13.38
		1pc	-->8983287	I-O-3	3/4	1-1/2	JIC-A44644	8.89
MODEL 580D, 580 Super D								
3-PT HITCH LIFT		1pc		P-UB-10	1-1/2	3	JIC-G109452	25.39
3-PT HITCH PITCH		1pc		P-UB-10	1-1/4	2-1/2	JIC-G109476	27.34
3-PT HITCH TILT		1pc		P-UB-10	1-1/4	2-1/2	JIC-G109475	28.43
BACKHOE BOOM		1pc		P-UB-10	1-3/4	3-1/4	JIC-1543265C1	43.07
BACKHOE BUCKET		1pc		P-UB-10	2-1/2	3-1/2	JIC-G109504	37.16
		1pc		P-UB-10	2	3-1/2	JIC-G109453	37.63
BACKHOE DIPPER		1pc		P-UB-10	2-1/2	4	JIC-G109424	43.95
		1pc		P-UB-10	2	4	JIC-1543273C1	47.24
BACKHOE DIPPER EXT		1pc		P-UB-10	1-1/2	3	JIC-G109452	25.39
BACKHOE STABILIZER		1pc		P-UB-10	2	4	JIC-1543273C1	47.24
BACKHOE SWING		1pc		P-UB-10	2	4	JIC-1543273C1	47.24
LOADER CLAM		1pc		P-UB-10	1-3/4	3	JIC-1543262C1	34.76
LOADER LIFT		1pc		P-UB-10	1-3/4	3	JIC-1543262C1	34.76
LOADER TILT		1pc		P-UB-10	1-1/2	2-1/2	JIC-1543253C1	36.88
STEERING		1pc		I-U-10	3/4	1-1/2	JIC-D148100	13.38

CASE



CASE

Replacement Kits For

Wheeled Backhoe Loaders								
APPLICATION	CYL #	Piston	SERIAL #	CODE	ROD	BORE	KIT #	List \$
MODEL 580 Super E								
3-PT HITCH LIFT		1pc		P-UB-10	1-1/2	3	JIC-G109452	25.39
3-PT HITCH PITCH		1pc		P-UB-10	1-1/4	2-1/2	JIC-G109476	27.34
3-PT HITCH TILT		1pc		P-UB-10	1-1/4	2-1/2	JIC-G109475	28.43
BACKHOE BOOM		1pc		P-UB-10	1-3/4	3-1/4	JIC-1543265C1	43.07
BACKHOE BUCKET		1pc		P-UB-10	2-1/2	3-1/2	JIC-G109504	37.16
		1pc		P-UB-10	2-1/2	4	JIC-G109424	43.95
BACKHOE DIPPER		1pc		P-UB-10	2	4	JIC-1543273C1	47.24
BACKHOE DIPPER EXT		1pc		P-UB-10	1-1/2	3	JIC-G109452	25.39
BACKHOE STABILIZER		1pc		P-UB-10	2	4	JIC-1543273C1	47.24
BACKHOE SWING		1pc		P-UB-10	2	4	JIC-1543273C1	47.24
LOADER CLAM		1pc		P-UB-10	1-3/4	3	JIC-1543262C1	34.76
LOADER LIFT		1pc		P-UB-10	1-3/4	3	JIC-1543262C1	34.76
LOADER TILT		1pc		P-UB-10	1-1/2	2-1/2	JIC-1543253C1	36.88
STEERING		1pc		I-U-10	3/4	1-1/2	JIC-D148100	13.38
MODEL 580F								
BACKHOE BOOM		1pc		P-UB-10	1-3/4	3-1/4	JIC-G105547	38.44
		2pc		P-UB-9	1-3/4	3-1/4	JIC-G105528	36.68
BACKHOE BUCKET		2pc		P-UB-9	2	3-1/2	JIC-G105527	42.05
		1pc		P-UB-10	2	3-1/2	JIC-G105546	37.63
BACKHOE DIPPER		2pc		P-UB-9	2	4	JIC-G105517	38.79
		1pc		P-UB-10	2	4	JIC-1543273C1	47.24
BACKHOE STABILIZER		1pc	3.785.896-UP	P-UB-10	1-3/4	3	JIC-G105549	42.54
		2pc	-->3.785.895	P-UB-9	1-3/4	3	JIC-G105524	42.23
		2pc	-->3.775.176	P-UB-9	2	4	JIC-G105517	38.79
		1pc	3.775.177-UP	P-UB-10	2	4	JIC-1543273C1	47.24
BACKHOE SWING		2pc	-->3.785.922	P-U-9	1-3/4	4	JIC-G34626	39.61
		1pc	3.785.923-3.787.235	P-UB-10	1-3/4	4	JIC-G105552	40.06
		2pc	-->3.775.161	P-UB-9	2	4	JIC-G105517	38.79
		1pc	3.775.162-UP	P-UB-10	2	4	JIC-1543273C1	47.24
BOOM EXTENSION		2pc		P-UB-9	1-1/2	3	JIC-G105512	38.33
		1pc		P-UB-10	1-1/2	3	JIC-G105548	33.43
LOADER CLAM		1pc		P-UB-10	1-3/4	3	JIC-G105549	42.54
		2pc		P-UB-9	1-3/4	3	JIC-G105524	42.23
LOADER LIFT		1pc		P-UB-10	2	3-1/4	JIC-G105553	42.15
LOADER TILT		2pc		P-U-9	1-1/2	2-1/2	JIC-G32294	26.40
		1pc		P-UB-10	1-1/2	2-1/2	JIC-G105550	25.09
STEERING		1pc	3.736.937-UP	I-U-10	3/4	1-1/2	JIC-D148100	13.38
MODEL 580K								
3-PT HITCH LIFT & TILT		1pc		P-UB-10	1-1/4	3	JIC-G110048	26.15
		1pc		P-UB-10	1-1/4	2-3/4	JIC-G110047	27.68
BACKHOE BOOM		1pc		P-UB-10	2-1/4	5	JIC-G110583	107.08
BACKHOE BUCKET		1pc		P-UB-10	2-1/2	3-1/2	JIC-G110046	36.83
BACKHOE DIPPER		1pc		P-UB-10	2-1/2	5	JIC-1542915C2	51.36
BACKHOE DIPPER EXT		1pc		P-UB-10	1-3/4	3	JIC-G110049	32.94
BACKHOE STABILIZER		1pc		P-UB-10	2	4-1/4	JIC-1543275C1	45.65

NORTH AMERICA
PHONE 1-800-777-5617
FAX 1-800-759-6391

SALES OFFICE HOURS
8 A.M. TO 8 P.M. EASTERN TIME
www.HerculesUS.com

WORLDWIDE
PHONE 1-727-796-1300
FAX 1-727-797-8849



CASE

Replacement Kits For

Wheeled Backhoe Loaders								
APPLICATION	CYL #	Piston	SERIAL #	CODE	ROD	BORE	KIT #	List \$
MODEL 580K								
BACKHOE SWING		1pc		P-UB-10	1-3/4	3-1/2	JIC-G110621	34.30
		1pc		P-UB-10	1-3/4	3-1/4	JIC-G110053	30.21
LOADER CLAM		1pc		P-UB-10	1-3/4	3	JIC-1543262C1	34.76
LOADER LIFT		1pc		P-UB-10	1-3/4	3-1/4	JIC-G110053	30.21
LOADER TILT		1pc		P-UB-10	1-1/2	3	JIC-G110050	29.07
SIDE SHIFT STABILIZER		1pc		P-UB-10	1-3/4	3	JIC-1543262C1	34.76
SIDE SHIFT SWING		1pc		P-UB-10	2	4	JIC-1543269C1	43.21
STEERING		1pc		P-U-10	1-1/2	2-3/4	JIC-G110045	38.14
MODEL 580 Super K								
BACKHOE BOOM		1pc		P-UB-10	2-1/4	5	JIC-G110583	107.08
BACKHOE BUCKET		1pc		P-UB-10	2-1/2	3-1/2	JIC-G110046	36.83
BACKHOE DIPPER		1pc		P-UB-10	2-1/2	5	JIC-G110582	44.59
BACKHOE DIPPER EXT		1pc		P-UB-10	1-3/4	3	JIC-G110049	32.94
BACKHOE STABILIZER		1pc		P-UB-10	2	4-1/4	JIC-1543275C1	45.65
BACKHOE SWING		1pc		P-UB-10	1-3/4	3-1/2	JIC-G110621	34.30
LOADER CLAM		1pc		P-UB-10	1-3/4	3	JIC-1543262C1	34.76
LOADER LIFT		1pc		P-UB-10	1-3/4	3-1/2	JIC-G110621	34.30
LOADER TILT		1pc		P-UB-10	1-1/2	3	JIC-G110050	29.07
SIDE SHIFT SWING		1pc		P-UB-10	2-1/4	4-1/2	JIC-1543279C1	48.40
MODEL 580L								
3-PT HITCH LIFT	137512A1	1pc		P-UB-10	1-1/2	3	JIC-1543256C1	34.04
	137912A1	1pc		P-U-10	1-1/4	2-1/2	JIC-183286A1	39.21
	196832A1	1pc		P-UB-10	1-1/2	3	JIC-1543256C1	34.04
3-PT HITCH PITCH	138235A1	1pc		P-U-10	1-1/4	2-1/2	JIC-183286A1	39.21
BACKHOE BOOM	182106A1	1pc		P-UB-10	2-1/4	4-1/2	JIC-182218A1	76.63
BACKHOE BUCKET	128760A1	1pc		P-UB-10	2-1/4	3-1/4	JIC-131750A2	53.22
BACKHOE DIPPER	175774A1	1pc		P-UB-10	2-1/4	4-1/4	JIC-234844A1	79.55
	233114A1	1pc		P-UB-10	2-1/4	4-1/4	JIC-234844A1	79.55
BACKHOE DIPPER EXT	1340970C2	1pc		P-UB-10	1-3/4	3	JIC-1543267C1	42.08
BACKHOE STABILIZER	143574A1	1pc		P-UB-10	2	4	JIC-1543269C1	43.21
	143575A1	1pc		P-UB-10	2	4	JIC-1543269C1	43.21
	195503A1	1pc		P-UB-10	2	4	JIC-1543269C1	43.21
	195504A1	1pc		P-UB-10	2	4	JIC-1543269C1	43.21
BACKHOE SWING	139808A1	1pc		P-UB-10	2	4	JIC-122535A1	72.81
	139808A2	1pc		P-UB-10	2	4	JIC-122535A1	72.81
	188027A1	1pc		P-UB-10	2	3-3/4	JIC-191747A1	72.93
LOADER BUCKET	175238A1	1pc		P-UB-10	1-1/2	2-3/4	JIC-175251A1	55.29
LOADER CLAM	1346189C1	1pc		P-UB-10	1-3/4	3	JIC-1543267C1	42.08
LOADER LIFT	131417A1	1pc		P-UB-10	1-3/4	3	JIC-1543267C1	42.08
MODEL 580 Super L Construction King								
BACKHOE BOOM	144200A1			P-UB-10	2-1/4	5	JIC-1542919C2	116.21
BACKHOE BUCKET	110290A1			P-UB-10	2-1/2	3-1/2	JIC-1542923C2	54.33
	235916A1			P-UB-10	2-1/2	3-1/2	JIC-1542923C2	54.33
BACKHOE DIPPER	126151A1			P-UB-10	2-1/2	5	JIC-1542915C2	51.36
	183795A1			P-UB-10	2-1/2	5	JIC-1542915C2	51.36
BACKHOE DIPPER EXT	1340969C2			P-UB-10	1-3/4	3	JIC-1543267C1	42.08

CASE

NORTH AMERICA
 PHONE 1-800-777-5617
 FAX 1-800-759-6391

SALES OFFICE HOURS
 8 A.M. TO 8 P.M. EASTERN TIME
www.HerculesUS.com

WORLDWIDE
 PHONE 1-727-796-1300
 FAX 1-727-797-8849



CASE

Replacement Kits For

Wheeled Backhoe Loaders

APPLICATION	CYL #	Piston	SERIAL #	CODE	ROD	BORE	KIT #	List \$
MODEL 580 Super L Construction King								
BACKHOE SWING	139808A1			P-UB-10	2	4	JIC-122535A1	72.81
	139808A2			P-UB-10	2	4	JIC-122535A1	72.81
LOADER BUCKET	113133A2			P-UB-10	1-1/2	3	JIC-1543256C1	34.04
LOADER CLAM - LH	1346189C1			P-UB-10	1-3/4	3	JIC-1543267C1	42.08
LOADER CLAM - RH	1346190C1			P-UB-10	1-3/4	3	JIC-1543267C1	42.08
LOADER LIFT	112366A2			P-UB-10	1-3/4	3-1/4	JIC-1543260C1	43.07
STABILIZER - LH	143697A1			P-UB-10	2	4-1/4	JIC-1543275C1	45.65
	199721A1			P-UB-10	2	4-1/4	JIC-1543275C1	45.65
STABILIZER - RH	143695A1			P-UB-10	2	4-1/4	JIC-1543275C1	45.65
	199720A1			P-UB-10	2	4-1/4	JIC-1543275C1	45.65
MODEL 580 Super L								
BACKHOE BOOM	144200A1	1pc		P-UB-10	2-1/4	5	JIC-1542919C2	116.21
BACKHOE BUCKET	110290A1	1pc		P-UB-10	2-1/2	3-1/2	JIC-1542923C2	54.33
	235916A1	1pc		P-UB-10	2-1/2	3-1/2	JIC-1542923C2	54.33
BACKHOE DIPPER	126151A1	1pc		P-UB-10	2-1/2	5	JIC-1542915C2	51.36
	183795A1	1pc		P-UB-10	2-1/2	5	JIC-1542915C2	51.36
	183795A2	1pc		P-UB-10	2-1/2	5	JIC-1542915C2	51.36
BACKHOE DIPPER EXT	1340969C2	1pc		P-UB-10	1-3/4	3	JIC-1543267C1	42.08
BACKHOE STABILIZER	143695A1	1pc		P-UB-10	2	4-1/4	JIC-1543275C1	45.65
	143697A1	1pc		P-UB-10	2	4-1/4	JIC-1543275C1	45.65
	199720A1	1pc		P-UB-10	2	4-1/4	JIC-1543275C1	45.65
	199721A1	1pc		P-UB-10	2	4-1/4	JIC-1543275C1	45.65
BACKHOE SWING	139808A1	1pc		P-UB-10	2	4	JIC-122535A1	72.81
LOADER BUCKET	113133A2	1pc		P-UB-10	1-1/2	3	JIC-1543256C1	34.04
LOADER CLAM	1346189C1	1pc		P-UB-10	1-3/4	3	JIC-1543267C1	42.08
	1346190C1	1pc		P-UB-10	1-3/4	3	JIC-1543267C1	42.08
LOADER LIFT	112366A2	1pc		P-UB-10	1-3/4	3-1/4	JIC-1543260C1	43.07
MODEL 580M								
BACKHOE BOOM	189653A2			P-UB-10	2-1/4	4-1/2	JIC-182218A1	76.63
BACKHOE BUCKET	128760A1			P-UB-10	2-1/4	3-1/4	JIC-131750A2	53.22
BACKHOE DIPPER	233114A2			P-UB-10	2-1/4	4-1/4	JIC-234844A1	79.55
BACKHOE EXT. DIPPER	1340969C2			P-UB-10	1-3/4	3	JIC-1543267C1	42.08
BACKHOE STABILIZER	195503A1			P-UB-10	2	4	JIC-1543269C1	43.21
BACKHOE SWING	188027A2			P-UB-10	2	3-3/4	JIC-191747A1	72.93
LOADER BUCKET	113133A2			P-UB-10	1-1/2	3	JIC-1543256C1	34.04
LOADER CLAM	1346189C1			P-UB-10	1-3/4	3	JIC-1543267C1	42.08
LOADER LIFT	384240A1			P-UB-10	1-3/4	3-1/4	JIC-1543260C1	43.07
MODEL 580 Super M								
BACKHOE BOOM				P-UB-10	2-1/4	5	JIC-1542919C4	126.82
MODEL 590								
BACKHOE BOOM	1980395C5	1pc		P-UB-10	2-1/2	5-1/2	JIC-1980412C2	155.04
	1980395C6	1pc		P-UB-10	2-1/2	5-1/2	JIC-1980412C2	155.04
BACKHOE BUCKET	1986902C1	1pc		P-UB-10	2-1/2	3-1/2	JIC-1542923C2	54.33
	1986902C2	1pc		P-UB-10	2-1/2	3-1/2	JIC-1542923C2	54.33
BACKHOE DIPPER	1994520C1	1pc		P-UB-10	2-3/4	5-1/2	JIC-1994527C2	150.74
	1994520C2	1pc		P-UB-10	2-3/4	5-1/2	JIC-1994527C2	150.74



CASE

Replacement Kits For

Wheeled Backhoe Loaders								
APPLICATION	CYL #	Piston	SERIAL #	CODE	ROD	BORE	KIT #	List \$
MODEL 590								
BACKHOE DIPPER EXT	1340853C2	1pc		P-UB-10	1-3/4	3	JIC-1543267C1	42.08
BACKHOE STABILIZER	110885A1	1pc		P-UB-10	2-1/4	5	JIC-1543289C2	66.28
	110886A1	1pc		P-UB-10	2-1/4	5	JIC-1543289C2	66.28
	1986810C1	1pc		P-UB-10	2-1/4	5	JIC-1543289C2	66.28
	1986811C1	1pc		P-UB-10	2-1/4	5	JIC-1543289C2	66.28
BACKHOE SWING	1343584C1	1pc		P-UB-10	2	3-3/4	JIC-1980181C2	49.21
	1343584C2	1pc		P-UB-10	2	3-3/4	JIC-1980181C2	49.21
LOADER BUCKET	110306A1	1pc		P-UB-10	1-1/2	3	JIC-1543256C1	34.04
	110309A1	1pc		P-UB-10	1-1/2	3	JIC-1543256C1	34.04
	G108486	1pc		P-UB-10	1-1/2	3	JIC-1543256C1	34.04
	G108487	1pc		P-UB-10	1-1/2	3	JIC-1543256C1	34.04
LOADER CLAM	1346189C1	1pc		P-UB-10	1-3/4	3	JIC-1543267C1	42.08
	1346190C1	1pc		P-UB-10	1-3/4	3	JIC-1543267C1	42.08
LOADER LIFT	110875A1	1pc		P-UB-10	1-3/4	3-1/2	JIC-1543266C1	42.86
	1542743C1	1pc		P-UB-10	1-3/4	3-1/2	JIC-1543266C1	42.86
	1980220C2	1pc		P-UB-10	1-3/4	3-1/2	JIC-1543266C1	42.86
MODEL 590 Super L								
BACKHOE BOOM	175785A1	1pc		P-UB-10	2-1/2	5-1/2	JIC-1980412C2	155.04
BACKHOE BUCKET	1986902C2	1pc		P-UB-10	2-1/2	3-1/2	JIC-1542923C2	54.33
	238435A1	1pc		P-UB-10	2-1/2	3-1/2	JIC-1542923C2	54.33
BACKHOE DIPPER	140965A1	1pc		P-UB-10	2-3/4	5-1/2	JIC-179011A1	119.03
BACKHOE DIPPER EXT	1340853C2	1pc		P-UB-10	1-3/4	3	JIC-1543267C1	42.08
BACKHOE STABILIZER	177256A1	1pc		P-UB-10	2-1/4	5	JIC-1543289C2	66.28
	177257A1	1pc		P-UB-10	2-1/4	5	JIC-1543289C2	66.28
BACKHOE SWING	139808A1	1pc		P-UB-10	2	4	JIC-122535A1	72.81
LOADER BUCKET	113133A2	1pc		P-UB-10	1-1/2	3	JIC-1543256C1	34.04
LOADER CLAM	1346189C1	1pc		P-UB-10	1-3/4	3	JIC-1543267C1	42.08
	1346190C1	1pc		P-UB-10	1-3/4	3	JIC-1543267C1	42.08
LOADER LIFT	133936A1	1pc		P-UB-10	1-3/4	3-1/2	JIC-1543266C1	42.86
MODEL 590 Super M								
BACKHOE BOOM	175785A1			P-UB-10	2-1/2	5-1/2	JIC-1980412C2	155.04
BACKHOE DIPPER	140965A1			P-UB-10	2-3/4	5-1/2	JIC-179011A1	119.03
BACKHOE EXT. DIPPER	1340853C1			P-UB-10	1-3/4	3	JIC-1543267C1	42.08
BACKHOE SWING	139808A2			P-UB-10	2	4	JIC-122535A1	72.81
LOADER BUCKET	255756A1			P-UB-10	1-3/4	3-1/4	JIC-1543260C1	43.07
LOADER CLAM	1346189C1			P-UB-10	1-3/4	3	JIC-1543267C1	42.08
	1346190C1			P-UB-10	1-3/4	3	JIC-1543267C1	42.08
LOADER LIFT	133936A1			P-UB-10	1-3/4	3-1/2	JIC-1543266C1	42.86
STEERING	1986518C2			P-U-10	1-1/2	2-3/4	JIC-G110045	38.14
MODEL 680								
3-PT HITCH PITCH		1pc	ALL	P-UB-10	1-1/4	2-1/2	JIC-G110055	42.88
BACKHOE BOOM				P-U-1	2-1/4		JIC-D42878	15.98
		2pc		N-N-9		4-1/2	JIC-DTVS4.5P	34.76
BACKHOE BUCKET		2pc		N-N-9		4	JIC-G33239	17.54
				I-U-1	2-1/4		JIC-D42877	13.02
BACKHOE DIPPER				P-U-1	2-1/4		JIC-D42878	15.98

CASE



CASE

Replacement Kits For

Wheeled Backhoe Loaders								
APPLICATION	CYL #	Piston	SERIAL #	CODE	ROD	BORE	KIT #	List \$
MODEL 680								
BACKHOE DIPPER		2pc		N-N-9		4-1/2	JIC-DTVS4.5P	34.76
BACKHOE STABILIZER				P-U-1	1-3/4		JIC-D42873	17.99
		2pc		N-N-9		3-1/2	JIC-G33237	16.09
BACKHOE SWING				P-U-1	1-3/4		JIC-D42875	13.93
		2pc		N-N-9		4	JIC-G33239	17.54
LOADER TILT				P-U-1	1-3/4		JIC-D42873	17.99
		2pc		N-N-9		3-1/2	JIC-G33237	16.09
MODEL 680B								
BACKHOE BOOM		2pc		P-U-9	2-1/4	5	JIC-G32696	49.15
BACKHOE BUCKET		2pc		P-UB-9	2-1/2	4	JIC-G34636	44.02
		2pc		N-N-9		4	JIC-G33239	17.54
				I-U-1	2-1/4		JIC-D42877	13.02
BACKHOE DIPPER		2pc		P-UB-9	2-1/4	4-1/2	JIC-G105520	62.28
		2pc		N-N-9		4-1/2	JIC-DTVS4.5P	34.76
				P-U-1	2-1/4		JIC-D42878	15.98
BACKHOE STABILIZER				I-U-1	2		JIC-D42876	14.20
		2pc		P-U-9	2	4	JIC-G32299	38.14
		2pc		N-N-9		4	JIC-G33239	17.54
BACKHOE SWING		2pc		P-UB-9	2	4-1/2	JIC-G105525	49.88
		2pc		P-U-9	2	4-1/2	JIC-G32695	51.36
LOADER HYDRA-LEVELING		2pc		P-UB-9	1-3/4	3	JIC-G105524	42.23
		2pc		N-N-9		3	JIC-G33151	14.53
				P-U-1	1-3/4		JIC-D42872	13.12
LOADER LIFT		2pc		N-N-9		3-1/2	JIC-G33237	16.09
				I-U-1	2		JIC-D42874	11.82
		2pc		P-U-9	2	3-1/2	JIC-G34648	38.89
LOADER TILT		2pc		N-N-9		3	JIC-G33151	14.53
		2pc		P-UB-9	1-3/4	3	JIC-G105524	42.23
				P-U-1	1-3/4		JIC-D42872	13.12
MODEL 680C								
3-PT HITCH PITCH		1pc		P-UB-10	1-1/2	2-1/2	JIC-G105550	25.09
		2pc		P-U-9	1-1/2	2-1/2	JIC-G32294	26.40
3-PT HITCH TILT		2pc		P-U-9	1-1/2	2-1/2	JIC-G32294	26.40
		1pc		P-UB-10	1-1/2	2-1/2	JIC-G105550	25.09
BACKHOE BOOM		2pc		P-U-9	2-1/4	5	JIC-G32696	49.15
BACKHOE BUCKET		1pc		P-UB-10	1-1/4	2-1/2	JIC-G105551	28.43
		2pc		P-UB-9	2-1/2	4	JIC-G34636	44.02
BACKHOE DIPPER		2pc		N-N-9		4-1/2	JIC-DTVS4.5P	34.76
		2pc		P-UB-9	2-1/4	4-1/2	JIC-G105520	62.28
				P-U-1	2-1/4		JIC-D42878	15.98
		2pc		P-UB-9	1-1/2	3	JIC-G105512	38.33
BACKHOE DIPPER EXT		2pc		P-UB-9	1-1/2	3	JIC-G105512	38.33
BACKHOE STABILIZER		2pc		N-N-9		4	JIC-G33239	17.54
		1pc		P-UB-10	2	4	JIC-1543273C1	47.24
		2pc		P-U-9	2	4	JIC-G32299	38.14



Replacement Kits For

CASE

Wheeled Backhoe Loaders								
APPLICATION	CYL #	Piston	SERIAL #	CODE	ROD	BORE	KIT #	List \$
MODEL 680C								
BACKHOE STABILIZER				I-U-1	2		JIC-D42876	14.20
		2pc		P-UB-9	2	4	JIC-G105517	38.79
BACKHOE SWING		2pc		P-UB-9	2	4-1/2	JIC-G105525	49.88
		2pc		P-U-9	2	4-1/2	JIC-G32695	51.36
LOADER CLAM		2pc		P-UB-9	1-1/2	3	JIC-G105512	38.33
		1pc		P-UB-10	1-1/2	3	JIC-G105548	33.43
LOADER HYDRA-LEVELING		1pc		P-UB-10	1-1/2	3	JIC-G105548	33.43
		2pc		P-UB-9	1-3/4	3	JIC-G105524	42.23
LOADER LIFT		2pc		P-U-9	2	3-1/2	JIC-G34648	38.89
		2pc		P-UB-9	2	3-1/2	JIC-G105521	36.68
		1pc		P-UB-10	2	3-1/2	JIC-G105546	37.63
LOADER TILT		1pc		P-UB-10	1-3/4	3	JIC-G105549	42.54
		2pc		P-U-9	1-3/4	3	JIC-G34643	33.74
		2pc		P-UB-9	1-3/4	3	JIC-G105524	42.23
MODEL 680CK								
BACKHOE BOOM				P-U-1	2-1/4		JIC-D42878	15.98
		2pc		N-N-9		4-1/2	JIC-DTVS4.5P	34.76
BACKHOE BUCKET				I-U-1	2-1/4		JIC-D42877	13.02
		2pc		N-N-9		4	JIC-G33239	17.54
BACKHOE DIPPER				P-U-1	2-1/4		JIC-D42878	15.98
		2pc		N-N-9		4-1/2	JIC-DTVS4.5P	34.76
BACKHOE STABILIZER		2pc		N-N-9		4	JIC-G33239	17.54
				I-U-1	2		JIC-D42876	14.20
BACKHOE SWING		2pc		N-N-9		4	JIC-G33239	17.54
				P-U-1	1-3/4		JIC-D42875	13.93
LOADER HYDRA-LEVELING		2pc		N-N-9		3	JIC-G33151	14.53
				P-U-1	1-3/4		JIC-D42872	13.12
LOADER LIFT				I-U-1	2		JIC-D42874	11.82
		2pc		N-N-9		3-1/2	JIC-G33237	16.09
LOADER TILT				P-U-1	1-3/4		JIC-D42872	13.12
		2pc		N-N-9		3	JIC-G33151	14.53
MODEL 680E								
BACKHOE BOOM		1pc		P-UB-10	2-1/4	4	JIC-G105556	43.45
		2pc		P-U-9	2-1/4	4	JIC-G34827	44.02
BACKHOE BUCKET		2pc		P-UB-9	2-1/2	4	JIC-G34636	44.02
		1pc		P-UB-10	2-1/4	4	JIC-G105556	43.45
BACKHOE DIPPER		2pc		P-UB-9	2-1/2	4-1/2	JIC-G105513	64.23
BACKHOE DIPPER EXT		1pc		P-UB-10	1-1/2	3	JIC-G105548	33.43
		2pc		P-UB-9	1-1/2	3	JIC-G105512	38.33
BACKHOE STABILIZER		2pc		P-UB-9	2	4-1/2	JIC-G105525	49.88
BACKHOE SWING		2pc		P-UB-9	2	4	JIC-G105517	38.79
		1pc		P-UB-10	2	4	JIC-1543273C1	47.24
LOADER CLAM		1pc		P-UB-10	1-1/2	3	JIC-G105548	33.43
		2pc		P-UB-9	1-1/2	3	JIC-G105512	38.33

CASE



CASE

Replacement Kits For

Wheeled Backhoe Loaders

APPLICATION	CYL #	Piston	SERIAL #	CODE	ROD	BORE	KIT #	List \$
MODEL 680E								
LOADER LIFT		2pc		P-UB-9	2	3-1/2	JIC-G105521	36.68
		1pc		P-UB-10	2	3-1/2	JIC-G105546	37.63
LOADER TILT		1pc		P-UB-10	1-3/4	3	JIC-G105549	42.54
		2pc		P-U-9	1-3/4	3	JIC-G34643	33.74
STEERING		1pc		I-U-10	1-1/4	2-1/8	JIC-A43296	18.65
		1pc		P-U-10	1-1/4	2-1/8	JIC-G34819	20.25
		1pc		P-U-10	1-1/4	2-1/8	JIC-G101021	19.68
MODEL 680G, 680H								
BACKHOE BOOM		1pc		P-UB-10	2-1/4	4	JIC-G105556	43.45
BACKHOE BUCKET		1pc		P-UB-10	2-1/4	4	JIC-G105556	43.45
BACKHOE DIPPER		2pc		P-UB-9	2-1/2	4-1/2	JIC-G105513	64.23
BACKHOE DIPPER EXT		1pc		P-UB-10	1-1/2	3	JIC-G105548	33.43
BACKHOE STABILIZER		2pc		P-UB-9	2	4-1/2	JIC-G105525	49.88
BACKHOE SWING		1pc		P-UB-10	2	4	JIC-1543273C1	47.24
LOADER CLAM		1pc		P-UB-10	1-1/2	3	JIC-G105548	33.43
LOADER LIFT		1pc		P-UB-10	2	3-1/2	JIC-G105546	37.63
LOADER TILT		1pc		P-UB-10	1-3/4	3	JIC-G105549	42.54
STEERING		1pc		P-U-10	1-1/4	2-1/8	JIC-G34819	20.25
MODEL 680K								
BACKHOE BOOM		1pc		P-UB-10	2-1/4	4	JIC-G109505	39.90
BACKHOE BUCKET		1pc		P-UB-10	2-1/4	4	JIC-G109505	39.90
BACKHOE DIPPER		2pc		P-UB-9	2-1/2	4-1/2	JIC-G109498	59.24
BACKHOE DIPPER EXT		1pc		P-UB-10	1-1/2	3	JIC-G109452	25.39
BACKHOE SWING		1pc		P-UB-10	2	4	JIC-1543273C1	47.24
LOADER CLAM		1pc		P-UB-10	1-1/2	3	JIC-G109452	25.39
LOADER LIFT		1pc		P-UB-10	2	3-1/2	JIC-G109453	37.63
LOADER TILT		1pc		P-UB-10	1-3/4	3	JIC-1543262C1	34.76
STEERING		1pc		P-U-10	1-1/4	2-1/8	JIC-G34819	20.25
MODEL 680L								
BACKHOE BOOM	1343567C1	1pc		P-UB-10	2-1/4	4	JIC-1346478C2	72.23
	G101256	1pc		P-UB-10	2-1/4	4	JIC-1543277C1	48.67
BACKHOE BUCKET	1343602C1	1pc		P-UB-10	2-1/4	4	JIC-1346478C2	72.23
	G103856	1pc		P-UB-10	2-1/4	4	JIC-1543277C1	48.67
BACKHOE DIPPER	1345994C1	1pc		P-UB-10	2-1/2	4-1/2	JIC-1343707C2	57.53
	G101348	2pc		P-UB-9	2-1/2	4-1/2	JIC-1543291C1	62.74
BACKHOE DIPPER EXT	1980375C1	1pc		P-UB-10	1-1/2	3	JIC-1543256C1	34.04
BACKHOE STABILIZER	1986853C1	1pc		P-UB-10	2	4-1/2	JIC-1986856C2	62.43
	G102276	2pc		P-UB-9	2	4-1/2	JIC-1543270C1	60.90
BACKHOE SWING	1978339C1	1pc		P-UB-10	2	4	JIC-1543269C1	43.21
LOADER CLAM	D143217	1pc		P-UB-10	2	4	JIC-D143215	25.77
LOADER LIFT	G103073	1pc	-->JJG007050523, 526, 540, 547 & UP	P-UB-10	2-1/4	4	JIC-1543277C1	48.67
	G103457	1pc	-->JJG0070547; except 423, 526, & 540	P-UB-10	2	3-1/2	JIC-1543274C1	48.24
LOADER TILT	G101220	1pc		P-UB-10	1-3/4	3	JIC-1543262C1	34.76

NORTH AMERICA
PHONE 1-800-777-5617
FAX 1-800-759-6391

SALES OFFICE HOURS
8 A.M. TO 8 P.M. EASTERN TIME
www.HerculesUS.com

WORLDWIDE
PHONE 1-727-796-1300
FAX 1-727-797-8849



Replacement Kits For

CASE

Wheeled Backhoe Loaders								
APPLICATION	CYL #	Piston	SERIAL #	CODE	ROD	BORE	KIT #	List \$
MODEL 780								
BACKHOE BOOM		2pc		P-UB-9	2-1/2	4-1/2	JIC-G105513	64.23
BACKHOE BUCKET		2pc	5500550-UP	P-UB-9	3	5	JIC-G105531	60.15
		2pc	-->5500549	P-U-9	3	5	JIC-G32668	52.00
BACKHOE DIPPER		2pc		P-UB-9	3	6	JIC-G105516	64.64
BACKHOE DIPPER EXT		2pc		P-UB-9	2-1/2	4	JIC-G34636	44.02
		1pc		P-UB-10	2-1/4	4	JIC-G105556	43.45
BACKHOE STABILIZER		2pc		P-UB-9	2-1/2	4-1/2	JIC-G105513	64.23
BACKHOE SWING		2pc		P-UB-9	2-1/4	4-1/2	JIC-G105520	62.28
LOADER CLAM		1pc		P-UB-10	2	4	JIC-1543273C1	47.24
		2pc		P-U-9	2	4	JIC-G32299	38.14
LOADER HYDRA-LEVELING		2pc		P-UB-9	2	4	JIC-G105517	38.79
LOADER LIFT		2pc		P-UB-9	2-1/4	4-1/2	JIC-G105520	62.28
LOADER TILT		2pc		P-U-9	1-3/4	3-1/2	JIC-G105508	41.52
		2pc		P-U-9	1-3/4	3-1/2	JIC-G32228	34.04
MODEL 780B								
BACKHOE BOOM		1pc	ALL	P-UB-10	2-1/2	4-1/2	JIC-G105560	41.76
BACKHOE BUCKET		1pc	ALL	P-UB-10	2-1/2	4-1/2	JIC-G105560	41.76
BACKHOE DIPPER		1pc		P-UB-10	2-3/4	5	JIC-G105562	62.68
BACKHOE DIPPER EXT		1pc		P-UB-10	1-1/2	3	JIC-G105548	33.43
BACKHOE STABILIZER		1pc		P-UB-10	2-1/4	4-1/2	JIC-G105557	55.97
BACKHOE SWING		1pc		P-UB-10	2	4	JIC-1543273C1	47.24
LOADER CLAM		1pc		P-UB-10	2	4	JIC-1543273C1	47.24
LOADER LIFT		1pc		P-UB-10	2-1/4	4	JIC-G105556	43.45
LOADER TILT		1pc		P-UB-10	2	3-1/2	JIC-G105546	37.63
STEERING		1pc		P-U-10	1-1/4	2-1/8	JIC-G34819	20.25

CASE



REPLACEMENT KITS FOR CASE EQUIPMENT

IMPORTANT - PLEASE READ

If a kit part number is unknown, the machine model number, serial number, and cylinder application will help identify the repair kit you need.

Example: Model Number **580C**
 Serial Number **5411021**
 Cylinder Application **Backhoe Swing**

If none of the above information is known, size and description of the parts needed will almost always be sufficient.

CASE

Kit Number	Code (Pg. xiv)	Rod X Bore Size	List Price
JIC-110507A1	P-U-10	1-3/8 X 2	\$ 44.91
JIC-110510A1	P-U-10	1 X 2	44.91
JIC-122535A1	P-UB-10	2 X 4	72.81
JIC-128725A1	P-UB-10	1-1/2 X 2-1/2	24.36
JIC-128728A1	P-U-10	1-1/4 X 2-1/2	20.62
JIC-131750A2	P-UB-10	2-1/4 X 3-1/4	53.22
JIC-131790A1	P-UB-10	2-1/4 X 4-1/4	36.12
JIC-1343707C2	P-UB-10	2-1/2 X 4-1/2	57.53
JIC-1346357C2	P-UB-10	4 X 8	191.36
JIC-1346409C2	P-UB-10	1-1/2 X 2-3/4	56.25
JIC-1346478C2	P-UB-10	2-1/4 X 4	72.23
JIC-1542764C2	I-UB-10	1-1/2 X 2-1/2	44.07
JIC-1542874C1	N-UB-1	1-1/2	10.96
JIC-1542875C1	N-UB-1	1-3/4	13.55
JIC-1542877C1	N-UB-1	2-1/4	13.94
JIC-1542915C2	P-UB-10	2-1/2 X 5	51.36
JIC-1542919C2	P-UB-10	2-1/4 X 5	116.21
JIC-1542919C4	P-UB-10	2-1/4 X 5	126.82
JIC-1542923C2	P-UB-10	2-1/2 X 3-1/2	54.33
JIC-1543249C1	P-UB-10	1-1/4 X 2-1/2	39.53
JIC-1543250C1	P-UB-10	1-1/4 X 2-1/2	31.43
JIC-1543252C1	P-UB-10	1-1/2 X 3	36.15
JIC-1543253C1	P-UB-10	1-1/2 X 2-1/2	36.88
JIC-1543254C1	P-UB-10	1-1/2 X 3-1/2	39.58
JIC-1543256C1	P-UB-10	1-1/2 X 3	34.04
JIC-1543260C1	P-UB-10	1-3/4 X 3-1/4	43.07
JIC-1543261C1	p-ub-10	1-3/4 x 3-1/2	39.59
JIC-1543262C1	P-UB-10	1-3/4 X 3	34.76
JIC-1543263C1	P-UB-9	1-3/4 X 3	45.46
JIC-1543264C1	P-UB-10	1-3/4 X 4	43.79
JIC-1543265C1	P-UB-10	1-3/4 X 3-1/4	43.07
JIC-1543266C1	P-UB-10	1-3/4 X 3-1/2	42.86
JIC-1543267C1	P-UB-10	1-3/4 X 3	42.08
JIC-1543268C1	P-UB-10	2 X 3-1/4	40.29

Kit Number	Code (Pg. xiv)	Rod X Bore Size	List Price
JIC-1543269C1	P-UB-10	2 X 4	\$ 43.21
JIC-1543270C1	P-UB-10	2 X 4-1/2	60.90
JIC-1543271C1	P-UB-9	2 X 4	33.91
JIC-1543273C1	P-UB-10	2 X 4	47.24
JIC-1543274C1	P-UB-10	2 X 3-1/2	48.24
JIC-1543275C1	P-UB-10	2 X 4-1/4	45.65
JIC-1543276C1	P-UB-9	2-1/4 X 4-1/2	70.84
JIC-1543277C1	P-UB-10	2-1/4 X 4	48.67
JIC-1543279C1	P-UB-10	2-1/4 X 4-1/2	48.40
JIC-1543289C2	P-UB-10	2-1/4 X 5	66.28
JIC-1543291C1	P-UB-10	2-1/2 X 4-1/2	62.74
JIC-1543294C1	P-UB-10	2-1/2 X 3-1/2	39.59
JIC-1543303C1	P-UB-10	3 X 6-1/2	127.60
JIC-1543305C1	P-UB-10	3 X 5	76.14
JIC-1543306C1	P-UB-10	3 X 6	91.82
JIC-1543309C1	P-UB-10	3-1/2 X 7	133.30
JIC-1543312C1	P-UB-9	2-1/2 X 5	65.97
JIC-1543313C1	P-UB-10	1-1/2 X 3	42.91
JIC-1543378C1	P-UB-9	1-1/2X3	58.11
JIC-1543383C1	P-UB-9	2 X 3-1/2	57.87
JIC-156002A1	P-UB-10	110 X 160 mm	395.90
JIC-158846A1	P-UB-10	95 X 140 mm	308.57
JIC-160227A1	P-UB-10	105 X 150 mm	320.33
JIC-160229A1	P-UB-10	90 X 135 mm	241.27
JIC-160577A1	P-UB-10	85 X 125 mm	217.29
JIC-160579A1	P-UB-10	100 X 135 mm	307.62
JIC-160581A1	P-UB-10	80 X 120 mm	200.29
JIC-161912A1	P-UB-10	80 X 115 mm	227.16
JIC-161913A1	P-UB-10	90 X 125 mm	271.31
JIC-161914A1	P-UB-10	75 X 105 mm	238.49
JIC-162976A1	P-UB-10	70 X 95 mm	209.39
JIC-164183A1	P-UB-10	85 X 125 mm	214.61
JIC-164493A1	P-UB-10	75 X 100 mm	149.65
JIC-164494A1	P-UB-10	80 X 115 mm	239.37

REPLACEMENT KITS FOR CASE EQUIPEMENT

Kit Number	Code (Pg. xiv)	Rod X Bore Size	List Price
JIC-175251A1	P-UB-10	1-1/2 X 2-3/4	\$ 55.29
JIC-179011A1	P-UB-10,12	2-1/2 X 5-1/2	119.03
JIC-182218A1	P-UB-10,12	2-1/4 X 4-1/2	76.63
JIC-183286A1	P-U-10	1-1/4 X 2-1/2	39.21
JIC-191747A1	P-UB-10,12	2 X 3-3/4	72.93
JIC-1980161C1	P-UB-10	2 X 3-1/2	44.46
JIC-1980181C2	P-UB-10	2 X 3-3/4	49.21
JIC-1980412C2	P-UB-10	2-1/2 X 5-1/2	155.04
JIC-198376A2	P-UB-10	1-3/4 X 2-1/2	42.91
JIC-1986823C2	P-UB-10	3-1/2 X 6	127.33
JIC-1986856C2	P-UB-10	2 X 4-1/2	62.43
JIC-1986920C2	P-UB-10	4 X 7	146.71
JIC-1994527C2	P-UB-10	2-3/4 X 5-1/2	150.74
JIC-234844A1	P-UB-10,12	2-1/4 X 4-1/4	79.55
JIC-235933A1	P-U-10	1-3/4 X 3-1/2	26.65
JIC-55355C91	I-OB-10	1 X 2-1/2	59.78
JIC-700710260	P-U-10	1-3/8 X 3	66.06
JIC-907001	P-N-5	2 X 2	21.87
JIC-907001	TRACK ADJUSTER		21.87
JIC-A43296	I-U-10	1-1/4 X 2-1/8	18.65
JIC-A44644	I-O-3	3/4 X 1-1/2	8.89
JIC-D143215	I-U-10	2 X 4	25.77
JIC-D148100	I-U-13	3/4 X 1-1/2	13.38
JIC-D37360	I-U-9	1-1/2 X 2-1/2	24.05
JIC-D37361	I-U-9	1-1/2 X 2	22.01
JIC-D42867	I-U-1	1-1/4 ROD	14.05
JIC-D42869	I-U-1	1-1/2 ROD	17.66
JIC-D42870	I-U-1	1-1/2 ROD	17.52
JIC-D42872	I-U-1	1-3/4 ROD	13.12
JIC-D42873	I-U-1	1-3/4 ROD	17.99
JIC-D42874	I-U-1	2 ROD	11.82
JIC-D42875	I-U-1	1-3/4 ROD	13.93
JIC-D42876	I-U-1	2 ROD	14.20
JIC-D42877	I-U-1	2-1/4 ROD	13.02
JIC-D42878	P-U-1	2-1/4 ROD	15.98
JIC-D47651	I-U-1	2 ROD	12.43
JIC-D47896	I-U-1	1-1/2 ROD	14.14
JIC-D50279	I-U-9	3 X 5	41.90
JIC-D61006	P-U-10	1 X 2	6.61
JIC-D83184	I-U-11	3/4 X 1-1/2	13.38
JIC-G101021	P-U-10	1-1/4 X 2-1/8	19.68
JIC-G102401	USE JIC-G105545		

Kit Number	Code (Pg. xiv)	Rod X Bore Size	List Price
JIC-G102402	USE JIC-G105546		
JIC-G102403	USE JIC-G105547		
JIC-G102404	USE JIC-G105548		
JIC-G102405	USE JIC-G105549		
JIC-G102406	USE JIC-G105550		
JIC-G102407	USE JIC-G105551		
JIC-G102408	P-U-10	1-3/4 X 4	\$ 38.58
JIC-G102410	P-U-10	1-3/4 X 3-1/2	36.34
JIC-G102411	USE JIC-G105555		
JIC-G102412	USE JIC-G105556		
JIC-G105206	P-UB-10	1-1/2 X 2-3/4	38.45
JIC-G105502	P-UB-10	1-1/2 X 3	32.46
JIC-G105503	P-UB-9	1-1/2 X 2	31.83
JIC-G105505	P-UB-9	1-1/2 X 2-1/2	25.97
JIC-G105507	P-UB-10	1-1/4 X 2-1/2	22.57
JIC-G105508	P-U-9	1-3/4 X 3-1/2	41.52
JIC-G105510	P-UB-10	1-1/4 X 3	23.07
JIC-G105512	P-UB-9	1-1/2 X 3	38.33
JIC-G105513	P-UB-9	2-1/2 X 4-1/2	64.23
JIC-G105514	P-UB-9	2-1/2 X 5-1/2	55.50
JIC-G105515	P-UB-9	2-1/2 X 5	52.56
JIC-G105516	P-UB-9	3 X 6	64.64
JIC-G105517	P-UB-9	2 X 4	38.79
JIC-G105518	P-U-9	1-3/4 X 3-1/2	38.14
JIC-G105519	P-UB-9	1-3/4 X 4	36.58
JIC-G105520	P-UB-9	2-1/4 X 4-1/2	62.28
JIC-G105521	P-UB-9	2 X 3-1/2	36.68
JIC-G105523	P-UB-9	1-3/4 X 3	36.68
JIC-G105524	P-UB-9	1-3/4 X 3	42.23
JIC-G105525	P-UB-9	2 X 4-1/2	49.88
JIC-G105526	P-UB-9	2 X 4	40.35
JIC-G105527	P-UB-9	2 X 3-1/2	42.05
JIC-G105528	P-UB-8	1-3/4 X 3-1/4	36.68
JIC-G105529	P-UB-9	1-3/4 X 3-1/2	35.77
JIC-G105530	P-UB-9	2-1/4 X 5	62.35
JIC-G105531	P-UB-9	3 X 5	60.15
JIC-G105545	P-UB-10	2 X 4	42.54
JIC-G105546	P-UB-10	2 X 3-1/2	37.63
JIC-G105547	P-UB-10	1-3/4 X 3-1/4	38.44
JIC-G105548	P-UB-10	1-1/2 X 3	33.43
JIC-G105549	P-UB-10	1-3/4 X 3	42.54
JIC-G105550	P-UB-10	1-1/2 X 2-1/2	25.09

CASE



REPLACEMENT KITS FOR CASE EQUIPEMENT

CASE

Kit Number	Code (Pg. xiv)	Rod X Bore Size	List Price
JIC-G105551	P-UB-10	1-1/4 X 2-1/2	\$ 28.43
JIC-G105552	P-UB-10	1-3/4 X 4	40.06
JIC-G105553	P-UB-10	2 X 3-1/4	42.15
JIC-G105555	P-UB-10	1-1/2 X 3-1/2	31.46
JIC-G105556	P-UB-10	2-1/4 X 4	43.45
JIC-G105557	P-UB-10	2-1/4 X 4-1/2	55.97
JIC-G105560	P-UB-10	2-1/2 X 4-1/2	41.76
JIC-G105561	P-UB-10	2-1/2 X 4	38.14
JIC-G105562	P-UB-10	2-3/4 X 5	62.68
JIC-G105563	P-UB-10	2-1/2 X 3-1/2	42.11
JIC-G105566	P-UB-9	2-3/4 X 5-1/2	89.58
JIC-G109417	P-UB-10	1-3/4 X 3-1/4	38.44
JIC-G109418	P-UB-10	1-1/2 X 3	25.21
JIC-G109421	P-UB-9	2 X 4	29.43
JIC-G109423	P-UB-10	2 X 4	42.54
JIC-G109424	P-UB-10	2-1/2 X 4	43.95
JIC-G109452	P-UB-10	1-1/2 X 3	25.39
JIC-G109453	P-UB-10	2 X 3-1/2	37.63
JIC-G109454	P-UB-9	2 X 3-1/2	27.94
JIC-G109456	P-UB-10	1-1/2 X 2-1/2	25.09
JIC-G109458	P-UB-10	1-1/2 X 2-1/2	20.07
JIC-G109460	P-UB-10	1-3/4 X 3	27.59
JIC-G109462	P-UB-9	1-3/4 X 3	29.11
JIC-G109465	P-UB-10	2 X 3-1/4	39.86
JIC-G109470	P-UB-9	1-3/4 X 3-1/2	32.97
JIC-G109471	P-UB-10	1-3/4 X 3-1/2	36.68
JIC-G109472	P-UB-10	1-1/2 X 3-1/2	34.68
JIC-G109475	P-UB-10	1-1/4 X 2-1/2	28.43
JIC-G109476	P-UB-10	1-1/4 X 2-1/2	27.34
JIC-G109484	P-UB-9	1-1/2 X 2-1/2	30.69
JIC-G109498	P-UB-9	2-1/2 X 4-1/2	59.24
JIC-G109499	P-UB-9	2-1/2 X 5`	69.28
JIC-G109500	P-UB-9	3 X 5-1/2	79.91
JIC-G109501	P-UB-9	2-1/4 X 5	57.69
JIC-G109502	P-U-9	3 X 5	59.33
JIC-G109503	P-U-10	2-1/2 X 4-1/2	37.62
JIC-G109504	P-UB-10	2-1/2 X 3-1/2	37.16
JIC-G109505	P-UB-10	2-1/4 X 4	39.90
JIC-G110045	P-U-10	1-1/2 X 2-3/4	38.14
JIC-G110046	P-UB-10	2-1/2 X 3-1/2	36.83
JIC-G110047	P-UB-10	1-1/4 X 2-3/4	27.68
JIC-G110048	P-UB-10	1-1/4 X 3	26.15

Kit Number	Code (Pg. xiv)	Rod X Bore Size	List Price
JIC-G110049	P-UB-10	1-3/4 X 3	\$ 32.94
JIC-G110050	P-UB-10	1-1/2 X 3	29.07
JIC-G110053	P-UB-10	1-3/4 X 3-1/4	30.21
JIC-G110055	P-UB-10	1-1/4 X 2-1/2	42.88
JIC-G110526	P-UB-10	3 X 6	77.34
JIC-G110537	P-UB-10	2 X 4-1/4	40.83
JIC-G110582	P-UB-10	2-1/2 X 5	44.59
JIC-G110583	P-UB-10	2-1/4 X 5	107.08
JIC-G110621	P-UB-10	1-3/4 X 3-1/2	34.30
JIC-G32184	P-U-9	2-1/2 X 5	44.99
JIC-G32228	P-U-9	1-3/4 X 3-1/2	34.04
JIC-G32293	P-U-9	2 X 3-1/2	34.48
JIC-G32294	P-U-9	1-1/2 X 2-1/2	26.40
JIC-G32295	P-U-9	1-1/4 X 2-1/2	31.87
JIC-G32299	P-U-9	2 X 4	38.14
JIC-G32616	P-U-9	2 X 4	35.21
JIC-G32617	P-U-9	1-3/4 X 4	36.68
JIC-G32668	P-U-9	3 X 5	52.00
JIC-G32695	P-U-9	2 X 4-1/2	51.36
JIC-G32696	P-U-9	2-1/4 X 5	49.15
JIC-G32827	USE JIC-G105505		
JIC-G33141	USE JIC-G105507		
JIC-G33823	P-U-9	2-1/2 X 5-1/2	46.63
JIC-G34172	USE JIC-G105507		
JIC-G34205	USE JIC-G105510		
JIC-G34277	USE JIC-G109458		
JIC-G34332	USE JIC-G105512		
JIC-G34333	USE JIC-G105513		
JIC-G34334	P-U-9	3 X 5	64.11
JIC-G34335	P-U-9	2 X 4	35.95
JIC-G34536	USE JIC-G105514		
JIC-G34537	USE JIC-G105515		
JIC-G34569	USE JIC-G105516		
JIC-G34594	P-U-9	2 X 4	36.36
JIC-G34622	P-U-9	1-3/4 X 3-1/2	38.14
JIC-G34624	P-U-9	1-3/4 X 3-1/2	36.68
JIC-G34626	P-U-9	1-3/4 X 4	39.61
JIC-G34628	USE JIC-G105520		
JIC-G34630	USE JIC-G105521		
JIC-G34631	P-U-9	1-3/4 X 3-1/2	36.68
JIC-G34634	USE JIC-G105523		
JIC-G34636	P-U-9	2-1/4 X 4	44.02

REPLACEMENT KITS FOR CASE EQUIPEMENT

Kit Number	Code (Pg. xiv)	Rod X Bore Size	List Price
JIC-G34642	USE JIC-G105524		
JIC-G34643	P-U-9	1-3/4 X 3	\$ 33.74
JIC-G34644	USE JIC-G105525		
JIC-G34646	P-U-9	1-1/2 X 3.5	33.01
JIC-G34647	USE JIC-G105526		
JIC-G34648	P-U-9	2 X 3-1/2	38.89
JIC-G34651	USE JIC-G105527		
JIC-G34652	P-U-9	1-1/2 X 3-1/2	33.57
JIC-G34653	USE JIC-G105528		
JIC-G34655	P-U-9	1-3/4 X 3-1/2	34.48
JIC-G34656	P-U-10	1-1/2 X 3	30.81
JIC-G34752	USE JIC-G105530		
JIC-G34753	USE JIC-G105531		
JIC-G34807	P-U-10	1 X 2-1/2	14.11
JIC-G34819	P-U-10	1-1/4 X 2-1/8	20.25
JIC-G34827	P-U-9	2-1/4 X 4	44.02

Kit Number	Code (Pg. xiv)	Rod X Bore Size	List Price
JIC-G35374	P-U-10	1 X 3	\$ 21.51
JIC-G35378	P-U-10	1 X 2-1/2	13.62
JIC-H52704	P-OB-3	1 X 2	13.77
JIC-H53041	P-OB-1	3-3/4 Rod Kit	18.70
JIC-LZ00522	P-UB-10	70 X 95 mm	209.39
JIC-LZ00533	P-UB-10	90 X 130 mm	251.44
JIC-LZ00539	P-UP-10	75 X 100 mm	142.55
JIC-N14638	P-U-10	1 X 2	29.07
JIC-N14639	P-U-10	1-1/4 X 2	35.66
JIC-S300163	I-U-10	2 X 4	19.81
JIC-S301013	I-U-10	2-1/2 X 5	47.24
JIC-S301442	I-U-10	2 X 4	30.11
JIC-S92713	P-U-9	2-1/2 X 5	43.83
JIC-S92714	P-U-9	2-1/2 X 5-1/2	46.77
JIC-S92724	P-U-9	2-3/4 X 5-1/2	62.12

CASE



REPLACEMENT PARTS FOR CASE EQUIPEMENT

NOTE: Case part numbers are used as a reference only. We do not imply that these kits are original REPLACEMENT PARTS.

U-SEALS

Part Number	Rod Diameter	List Price
JIC-G34803	1	\$ 4.63
JIC-G35372	1	4.18
JIC-D36968	1-1/4	4.86
JIC-D60999	1-1/4	5.09
JIC-D36969	1-1/2	5.47
JIC-G107921	1-1/2	10.15
JIC-H436694	1-3/8	5.90
JIC-1542999C1	1-3/4	11.42
JIC-D36970	1-3/4	6.24
JIC-G107922	1-3/4	7.02
JIC-D36971	2	6.83
JIC-G107923	2	13.11
JIC-1986572C1	2-1/4	7.87
JIC-D39359	2-1/4	7.87
JIC-D45571	2-1/2	8.88
JIC-S220100	2-3/4	9.39
JIC-D45572	3	9.85
JIC-A137343	3-1/2	11.57
JIC-S118038	3-1/2	33.13

PISTON SEALS

Part Number	Bore Diameter	List Price
JIC-D60995	2	\$ 3.88
JIC-A61430	2-1/8	7.28
JIC-191319A1	2-1/2	12.46
JIC-G100712	2-1/2	18.66
JIC-G102289	2-1/2	7.90
JIC-G33140	2-1/2	7.08
JIC-258546A2	2-3/4	15.63
JIC-G102288	3	20.59
JIC-G32034	3	11.32
JIC-H120188	3	4.40
JIC-G102287	3-1/4	18.29
JIC-G100709	3-1/2	8.87
JIC-G102286	3-1/2	17.69
JIC-G1340764C1	3-3/4	18.50
JIC-G102285	4	18.29
JIC-G110531	4-1/4	20.15
JIC-G101994	4-1/2	18.81
JIC-S228607	6-1/2	31.32

WIPERS

Part Number	Rod Diameter	List Price
JIC-A44651	3/4	\$ 0.97
JIC-D60997	1	2.27
JIC-H746297	1	2.76
JIC-D27705	1-1/4	4.95
JIC-D95141	1-1/4	11.02
JIC-D27706	1-1/2	2.02
JIC-D95142	1-1/2	11.25
JIC-226847A1	1-3/8	11.15
JIC-H436692	1-3/8	2.49
JIC-403845R1	1-3/4	12.17
JIC-D27432	1-3/4	4.45
JIC-D95143	1-3/4	12.17
JIC-D27380	2	6.15
JIC-D95144	2	12.78
JIC-D39360	2-1/4	3.59
JIC-D43162	2-1/4	3.59
JIC-D95145	2-1/4	13.67
JIC-D95149	2-3/8	11.59
JIC-D95146	2-1/2	15.29
JIC-193965C91	2-3/4	17.32
JIC-H215202	2-3/4	5.16
JIC-D46180	3	4.30
JIC-D95148	3	18.03
JIC-L104363	3-1/4	16.59
JIC-S92653	3-1/2	24.04
JIC-S97854	3-1/2	24.04
JIC-S108245	4	33.85

REPLACEMENT PARTS FOR CASE EQUIPEMENT

NOTE: Case part numbers are used as a reference only. We do not imply that these kits are original REPLACEMENT PARTS.

BUFFER RINGS

Part Number	Rod Diameter	List Price
JIC-1542998C1	1-3/4	\$ 14.62
JIC-G109094	1-3/4	5.00
JIC-G107998	2-1/2	6.65

WEAR RINGS

Part Number	O.D. X Width	List Price
JIC-G102864	1-3/8 X 0.98	\$ 6.97
JIC-G102424	1-5/8 X 0.98	4.76
JIC-G102425	1-7/8 X 0.98	4.87
JIC-G101533	2-1/8 X 0.98	5.06
JIC-G101837	2-1/8 X 3/8	3.31
JIC-G34818	2-1/8 X 3/8	3.31
JIC-G102426	2-3/8 X 1.48	10.16
JIC-G1346476C1	2-3/8 X 0.98	3.67
JIC-G100714	2-1/2 X 3/8	3.42
JIC-G34805	2-1/2 X 3/8	3.42
JIC-G109908	2-5/8 X 0.98	3.57
JIC-G102427	2-5/8 X 1.48	9.06
JIC-G105187	2-3/4 X 3/8	3.47
JIC-G102428	2-7/8 X 1.48	9.41
JIC-H436691	3 X 1/4	3.19
JIC-G100449	3 X 3/8	3.53
JIC-G32033	3 X 3/8	3.53
JIC-G102429	3-1/8 X 1.48	10.86
JIC-S109445	3-1/4 X 3/8	3.62
JIC-G100711	3-1/2 X 3/8	3.65
JIC-S104133	3-3/4 X 1/2	3.71
JIC-G100448	4 X 3/8	4.62
JIC-A63393	4 X 5/8	4.35
JIC-G101996	4-1/2 X 3/4	4.25
JIC-S97856	6-1/2 X 1/2	5.12

O-RINGS

Part Number	Min. Pkg	List Price
JIC-22409R1	20	\$ 0.45
JIC-235-5234	20	0.50
JIC-238-5115	50	0.08
JIC-238-5116	50	0.08
JIC-238-5210	25	0.17
JIC-238-5214	50	0.14
JIC-238-5224	20	0.46
JIC-238-5226	20	0.33
JIC-238-5228	20	0.35
JIC-238-5230	20	0.42
JIC-238-5232	20	0.45
JIC-238-5234	20	0.50
JIC-238-5437	5	2.10
JIC-238-6218	19	0.26
JIC-238-6231	12	0.58
JIC-238-7113	15	0.32
JIC-A14515	20	0.28
JIC-A17526	50	0.07
JIC-A23316	10	0.97
JIC-A27365	50	0.08
JIC-A27384	10	1.10
JIC-A27410	50	0.07
JIC-A27507	10	0.67
JIC-A27510	10	0.94
JIC-A27994	20	0.55
JIC-A28239	5	1.50
JIC-A28318	20	0.42
JIC-A29456	50	0.16
JIC-A30095	20	0.50
JIC-A30097	50	0.17
JIC-A30915	20	0.18
JIC-A55800	5	1.29
JIC-A60212	20	0.25
JIC-A61429	20	0.24
JIC-A7156	20	0.46
JIC-A7982	50	0.14
JIC-D26115	20	0.33
JIC-D26820	20	0.20
JIC-D27878	20	0.25
JIC-D36183	10	1.10

O-RINGS

Part Number	Min. Pkg	List Price
JIC-F62075	50	\$ 0.09
JIC-G100444	13	0.88
JIC-G100710	13	1.01
JIC-G100713	13	0.77
JIC-G100959	3	2.69
JIC-G10347	10	1.06
JIC-G105104	5	2.23
JIC-G105183	5	1.67
JIC-G15457	20	0.59
JIC-G46889	20	0.52
JIC-H436690	20	0.49
JIC-H743591	10	0.67
JIC-N13688	12	0.58
JIC-T52486	19	0.29

CASE



REPLACEMENT PARTS FOR CASE

NOTE: Case part numbers are used as a reference only. We do not imply that these kits are original REPLACEMENT PARTS.

VEE SETS

Part Number	O.D.	List Price
SINGLE ACTING VEE SETS WITH NO CENTER BEARING		
JIC-G33186	3-1/4	\$ 9.83
JIC-D47205	4-1/2	19.08
JIC-D47207	5-1/2	17.59
JIC-SVS5.5P	5-1/2	17.59
JIC-D49321	6	18.24
JIC-SVS6.0P	6	18.24
DOUBLE ACTING VEE SETS WITH CENTER BEARING		
JIC-G33201	2	\$ 17.49
JIC-G33193	2-1/2	14.17
JIC-G33151	3	14.53
JIC-G33237	3-1/2	16.09
JIC-G33239	4	17.54
JIC-DTVS4.5P	4-1/2	34.76
JIC-D36906	5	32.34
JIC-D47206	5	32.34

BACK-UP RINGS

Part Number	Min. Pkg.	List Price
JIC-A35884	13	\$ 0.49
JIC-A45035	18	0.35
JIC-A62070	8	0.49
JIC-B92639	3	2.49
JIC-D28497	1	1.67
JIC-D28498	1	2.99
JIC-D28499	1	1.45
JIC-D28500	1	3.23
JIC-D38858	6	1.16
JIC-D39539	1	1.95
JIC-D42453	3	2.93
JIC-G109033	2	4.12
JIC-G109297	10	0.94
JIC-G109298	7	1.06
JIC-G109300	4	2.06

BACK-UP RINGS

Part Number	Min. Pkg.	List Price
JIC-G32105	3	\$ 2.71
JIC-G32122	6	1.16
JIC-G32126	5	1.35
JIC-G32129	7	1.06
JIC-G32176	5	1.68
JIC-G32284	3	2.35
JIC-G32626	9	0.76
JIC-G32649	2	4.00
JIC-G34260	3	3.40
JIC-H745760	7	1.03
JIC-H754606	6	1.03
JIC-S92644	3	3.08
JIC-S99881	2	3.91

CASE

NORTH AMERICA
PHONE 1-800-777-5617
FAX 1-800-759-6391

SALES OFFICE HOURS
8 A.M. TO 8 P.M. EASTERN TIME
www.HerculesUS.com

WORLDWIDE
PHONE 1-727-796-1300
FAX 1-727-797-8849

REPLACEMENT SEAL KITS FOR CATERPILLAR® EQUIPMENT*

Replacement Seal Kits By Machine Type Table of Contents

Machine Type		Page
Agricultural Tractors	65, 65B, 75, 65C, 65D, 70C, 65E, 69D, 73D, 75C, 75D, 75E, 75G, 85C	190
Articulated Dump Trucks	D25C, D25D, D30C, D30D, D35C, D35HP, D35HPC, D40D, D250B, D250D, D250E, D300B, D300B AG, D300B CANE H, D350B, D350C, D350D, D350E, D400, D400D, D400E	190 - 194
Backhoe-Loaders	416, 416B, 416C, 420D, 426, 426B, 426C, 428, 428B, 428C, 436, 436B, 436C, 438, 438B, 438C, 446, 446B	194 - 210
Bulldozers	3P, 3S, 4S, 5A, 5S, 6, 6S, 7A, 7S, 7U, 7SU, 8A, 8B, 8D, 8R, 8S, 8U, 9B, 9R, 9S, 9U	210 - 212
Excavators	215, 215C, 219, 215B, 215D, 219D, 225, 225B, 225D, 227, 229, 229D, 231D, 235, 235 FS, 235B, 235C, 235C FS, 235D, 245 FS, 245, 245B, 245B FS, 245D, 303C CR, 304C CR, 305C CR, 307, 307B, 308B, 311, 311B, 312, 312B, 312BL, 312C, 312CL, 313B, 315, 317, 315B, 315BL, 315C, 315CL, 317B, 317BL, 315L, 317N, 318B, 318BL, 320, 320B, 320BL, 320C, 320CL, 320CLN, 320CLRR, 320CLU, 320CS, 320CU, 320C6, 320D, 320DL, 320DLN, 320DLRR, 320DRR, 320L, 320N, 320S, 321B, 322, 322B, 322BL, 322C, 322C FM LGP, 322CL, 322CLN, 322L, 322N, 325, 325B, 325BL, 325C, 325CL, 325CLN, 325D, 325DL, 325DLN, 325L, 325N, 330, 330B, 330BL, 330C, 330CL, 330CLN, 330D, 330DL, 330DN, 330L, 345B, 345BL, 345C, 345CL, 350, 350L, 365, 365B, 375, 375L, E110, E110B, E120, E120B, E180, EL180, E200B, EL200B, E240, EL240, E240B, EL240B, E300, EL300, E300B, EL300B, M320	212 - 276
Front-Shovel Excavators	5080, 5110, 5230, 5230B	277
Integrated Toolcarriers	IT12, IT12B, IT12F, IT14B, IT14C, IT14F, IT14G, IT18, IT18B, IT18F, IT24F, IT28, IT28B, IT28F, IT28G, IT38F, IT38G, IT62G	277 - 283
Landfill Compactors	816, 816B, 816F, 826B, 826C, 826G, 836, 836C	283 - 284
Motor Graders	12, 12E, 12F, 12G, 12H, 14, 14D, 14E, 14G, 14H, 16, 16G, 16H, 24H, 112, 112E, 112F, 120, 120B, 120G, 120H, 130G, 135H, 140, 140B, 140G, 140H, 143H, 160G, 160H, 163H	284 - 298
Off-Highway Trucks	768, 768B, 768C, 769, 769B, 769C, 769D, 770, 771C, 771D, 772, 772B, 772E, 773, 773B, 773D, 773E, 773F, 775, 775B, 775D, 776C, 776D, 777, 777B, 777C, 777D, 777F, 783B, 785, 785B, 785C, 784B, 784C, 786, 789, 789B, 789C, 793, 793B, 793C	298 - 306
Pipelayers	561B, 561C, 561D, 571A, 571F, 571G, 572C, 572D, 572E, 572F, 572G, 578, 583H, 583K, 583R, 589, 591, 594, 594H, MD7, MD8, MDW8	306 - 308
Scrapers	611, 613, 613B, 613C, 613SC, 615, 615C, 615SC, 621, 621B, 621E, 621F, 621G, 621R, 621S, 621SC, 623, 623B, 623E, 623F, 623G, 623SC, 623SCG, 627, 627B, 627E, 627F, 627SC, 630, 630B, 630SC, 631, 631B, 631C, 631D, 631E, 631SC, 632, 633, 633B, 633C, 633D, 633SC, 637, 637B, 637D, 637E, 637SC, 639D, 639SC, 641, 641B, 641SC, 650, 650B, 651, 651B, 651C, 651E, 651SC, 657, 657B, 657E, 657SC, 660, 666B, 660B, 666, 660SC, 666SC, J621	308 - 327
Skidders	508, 515, 525, 517, 518, 518C, 520D, 522C, 520C, 525B, 527, 528, 528B, 530B, 535B, 545, FB508, FB518	327 - 329
Soil Compactors	815, 815B, 815F, 815S, 825, 825B, 825C, 825G, 835	330 - 331
Telehandlers	TH62, TH63, TH82, TH83	331
Track-Type Loaders	931, 931B, 931C, 933, 933C, 933E, 933F, 933G, 935B, 935C, 939, 939C, 941, 941B, 943, 943B, 951, 951B, 951C, 953, 953B, 953C, 955, 955C, 955E, 955F, 955H, 955K, 955L, 963, 963B, 963C, 973, 973C, 977, 977D, 977H, 977K, 977L, 983, 983B	332 - 346
Track-Type Tractors	D2, D3, D3 LGP, D3B, D3C, D4B, D4C, D4D, D4E, D4H, D4L, D4TSKH, D5, D5B, D5C, D5E, D5H, D5M, D5TSKH, D6, D6 LGP, D6B, D6C, D6D, D6E, D6G, D6H, D6M, D6R, D7, D7 LGP, D7A, D7B, D7C, D7D, 7E, D7F, D7G, D7H, D7R, D8, D8H, D8K, D8L, D8N, D8R, D9D, D9G, D9H, D9L, D9N, D9R, D10, D10N, D10R, D11N, D11R	346 - 367
Tractors	772, 772B, 776, 776B, 776C, 776D, 784C	367 - 368
Tree Harvesters	518	368
Wheel Loaders	902, 904, 906, 908, 910, 910E, 910F, 914, 914G, 916, 918F, 924F, 920, 924, 924G, 926, 926E, 928F, 928G, 930, 930R, 930T, 936, 936E, 936F, 938F, 938G, 944, 944A, 950, 950B, 950E, 950F, 950G, 950H, 960F, 960G, 962G, 966, 966A, 966B, 966C, 966D, 966E, 966F, 966G, 966H, 966R, 970F, 972G, 966R, 970F, 972G, 980, 980B, 980C, 980F, 980G, 988, 988B, 988F, 988G, 990, 992, 992B, 992C, 992D, G910, G916, G926, G936	368 - 386
Wheel Tractors	814, 814B, 814F, 814S, 824, 824B, 824C, 824S, 834S, 834U, 830M, 834, 834B, 834C	386 - 390
Alpha-Numeric Kit Listing		391 - 400
Caterpillar Individual Parts		401 - 417

CATERPILLAR®

All manufacturer's names, part numbers and descriptions are used for reference purposes only. We do not imply that any part shown is the product of these manufacturers. We also do not imply that the list price shown is exactly that of the manufacturer.



REPLACEMENT KITS FOR CATERPILLAR® EQUIPMENT

Agricultural Tractors							
APPLICATION	CYL #	Misc-Parts, Instructions, etc.	CODE	ROD	BORE	KIT #	List \$
MODEL 65, 65B, 75							
LIFT							
	9T2230		P-UB-10	2	4	CTC-1328816	78.46
	9T9517		P-UB-10	2	4	CTC-1328816	78.46
MODEL 65C, 65D, 70C							
LIFT							
	9T9517		P-UB-10	2	4	CTC-1328816	78.46
TENSIONER							
	1504382		P-U-10	2-3/4	9-1/4	CTC-1939271	197.98
	6E1428		P-U-10	2-3/4	9-1/4	CTC-1939271	197.98
MODEL 65E							
LIFT							
	9T9517		P-UB-10	2	4	CTC-1328816	78.46
TENSIONER							
	1483031		P-U-10	2-3/4	9-1/4	CTC-1939271	197.98
MODEL 69D							
STEERING							
	1100532		P-UB-10	2	3	CTC-7X2760	54.39
	9J1287		P-UB-10	2-3/8	3-3/4	CTC-7X2808	68.21
TENSIONER							
	4T4168		I-SP-10	4,6-1/2	5-3/4	CTC-8T4772	266.06
	9J4149		I-SP-10	4,6-1/2	5-3/4	CTC-8T4772	266.06
MODEL 73D							
STEERING RH							
	7J7686		P-UB-10	2-3/8	4	CTC-8T1389	40.27
TENSIONER							
	1455155		I-SP-10	5,7-1/2	8-1/4	CTC-8T9042	385.00
	9J2017		I-SP-10	5,7-1/2	8-1/4	CTC-8T9042	385.00
	9T3122		I-SP-10	5,7-1/2	8-1/4	CTC-8T9042	385.00
MODEL 75C							
LIFT							
	9T9517		P-UB-10	2	4	CTC-1328816	78.46
TENSIONER							
	1504382		P-U-10	2-3/4	9-1/4	CTC-1939271	197.98
	6E1428		P-U-10	2-3/4	9-1/4	CTC-1939271	197.98
MODEL 75D, 75E, 75G, 85C							
LIFT							
	9T9517		P-UB-10	2	4	CTC-1328816	78.46
Articulated Dump Trucks							
APPLICATION	CYL #	Misc-Parts, Instructions, etc.	CODE	ROD	BORE	KIT #	List \$
MODEL D25C							
HOIST							
	5U7777		I-U-3	3-1/2	5-1/2	CTC-5U7775	272.25
	6U6821		I-U-3	3-1/2	5-1/2	CTC-5U7775	272.25
STEERING							
	6U1040		I-U-5	2	4-1/2	CTC-6U9552	188.77
	7U2910		I-U-5	2	4-1/2	CTC-6U9552	188.77



REPLACEMENT KITS FOR CATERPILLAR® EQUIPMENT

Articulated Dump Trucks							
APPLICATION	CYL #	Misc-Parts, Instructions, etc.	CODE	ROD	BORE	KIT #	List \$
MODEL D25C							
SUSPENSION FRONT							
	6U4161		I-U-10	4	4-1/2	CTC-1045008	235.48
UNSPECIFIED APPLICATION							
	7U9508		I-U-10	4	4-1/2	CTC-1045008	235.48
MODEL D25D							
STEERING							
	1433299		I-UB-10	2	4-1/2	CTC-1857699	182.06
	1453620		P-UB-10	2	4-1/2	CTC-1857700	82.16
	7U2910		I-U-5	2	4-1/2	CTC-6U9552	188.77
SUSPENSION							
	1049660		P-UB-10	3-1/2	4-1/2	CTC-1942756	279.63
SUSPENSION REAR							
	7U9538		I-UB-10	2	4-1/2	CTC-7U9545	261.36
UNSPECIFIED APPLICATION							
	1511179		P-UB-10	3-1/2	4-1/2	CTC-1944399	206.79
	5U7777		I-U-3	3-1/2	5-1/2	CTC-5U7775	272.25
MODEL D30C							
HOIST							
	5U7777		I-U-3	3-1/2	5-1/2	CTC-5U7775	272.25
STEERING							
	6U1040		I-U-5	2	4-1/2	CTC-6U9552	188.77
	7U2910		I-U-5	2	4-1/2	CTC-6U9552	188.77
SUSPENSION FRONT							
	6U4161		I-U-10	4	4-1/2	CTC-1045008	235.48
UNSPECIFIED APPLICATION							
	7U9508		I-U-10	4	4-1/2	CTC-1045008	235.48
MODEL D30D							
STEERING							
	7U2910		I-U-5	2	4-1/2	CTC-6U9552	188.77
SUSPENSION							
	2U9448		I-U-10	4	4-1/2	CTC-1045008	235.48
SUSPENSION REAR							
	7U9538		I-UB-10	2	4-1/2	CTC-7U9545	261.36
UNSPECIFIED APPLICATION							
	5U7777		I-U-3	3-1/2	5-1/2	CTC-5U7775	272.25
	7U9508		I-U-10	4	4-1/2	CTC-1045008	235.48
MODEL D35C							
HOIST							
	5U7777		I-U-3	3-1/2	5-1/2	CTC-5U7775	272.25
STEERING							
	6U1040		I-U-5	2	4-1/2	CTC-6U9552	188.77
	7U2910		I-U-5	2	4-1/2	CTC-6U9552	188.77
SUSPENSION FRONT							
	6U4161		I-U-10	4	4-1/2	CTC-1045008	235.48
MODEL D35HP							
HOIST							
	5U7777		I-U-3	3-1/2	5-1/2	CTC-5U7775	272.25

CATERPILLAR®



REPLACEMENT KITS FOR CATERPILLAR® EQUIPMENT

Articulated Dump Trucks							
APPLICATION	CYL #	Misc-Parts, Instructions, etc.	CODE	ROD	BORE	KIT #	List \$
MODEL D35HP							
STEERING							
	6U1040		I-U-5	2	4-1/2	CTC-6U9552	188.77
MODEL D35HPC							
STEERING							
	7U2910		I-U-5	2	4-1/2	CTC-6U9552	188.77
UNSPECIFIED APPLICATION							
	5U7777		I-U-3	3-1/2	5-1/2	CTC-5U7775	272.25
	6U4161		I-U-10	4	4-1/2	CTC-1045008	235.48
	7U2910		I-U-5	2	4-1/2	CTC-6U9552	188.77
MODEL D40D							
STEERING							
	7U2910		I-U-5	2	4-1/2	CTC-6U9552	188.77
SUSPENSION REAR							
	7U9538		I-UB-10	2	4-1/2	CTC-7U9545	261.36
MODEL D250B							
HOIST							
	5U7773		I-U-3	3-1/2	5-1/2	CTC-5U7775	272.25
STEERING							
	5U9000		I-U-5	2	4-1/2	CTC-6U9552	188.77
MODEL D250D							
HOIST							
	1478507		P-UB-10	2-3/4	4	CTC-1944397	139.89
	7U6405		I-U-10	2-3/4	4	CTC-7U8075	216.60
SUSPENSION							
	7U7230		P-UB-10	4	4-1/2	CTC-1944396	206.38
UNSPECIFIED APPLICATION							
	1340006		P-UB-10	4	4-1/2	CTC-1944396	206.38
	1512611		P-UB-10	2	3	CTC-1857667	71.63
MODEL D250E							
HOIST							
	1218785		I-U-10	2-3/4	4	CTC-1915027	99.32
	1256187		P-U-10	3	4	CTC-1315423	180.05
	1478507		P-UB-10	2-3/4	4	CTC-1944397	139.89
STEERING							
	1185432		N-UB-10	2	4	CTC-1857687	126.05
	1466651		N-UB-10	2	4	CTC-1857687	126.05
SUSPENSION							
	1185432		N-UB-10	2	4	CTC-1857687	126.05
UNSPECIFIED APPLICATION							
	1340006		P-UB-10	4	4-1/2	CTC-1944396	206.38
	1447657		P-UB-10	4	4-1/2	CTC-1944396	206.38
	1512611		P-UB-10	2	3	CTC-1857667	71.63
	7U7230		P-UB-10	4	4-1/2	CTC-1944396	206.38
MODEL D300B							
HOIST							
	5U7773		I-U-3	3-1/2	5-1/2	CTC-5U7775	272.25



REPLACEMENT KITS FOR CATERPILLAR® EQUIPMENT

Articulated Dump Trucks							
APPLICATION	CYL #	Misc-Parts, Instructions, etc.	CODE	ROD	BORE	KIT #	List \$
MODEL D300B							
STEERING							
	5U9000		I-U-5	2	4-1/2	CTC-6U9552	188.77
MODEL D300B AG, D300B CANE H							
STEERING							
	5U9000		I-U-5	2	4-1/2	CTC-6U9552	188.77
MODEL D350B							
HOIST							
	5U7773		I-U-3	3-1/2	5-1/2	CTC-5U7775	272.25
MODEL D350C							
HOIST							
	5U7773		I-U-3	3-1/2	5-1/2	CTC-5U7775	272.25
STEERING							
	6U1040		I-U-5	2	4-1/2	CTC-6U9552	188.77
	7U2910		I-U-5	2	4-1/2	CTC-6U9552	188.77
SUSPENSION							
	6U4161	App requires 2 kits.	I-U-10	4	4-1/2	CTC-1045008	235.48
UNSPECIFIED APPLICATION							
	7U2476		I-U-10	4	4-1/2	CTC-7U2486	273.10
MODEL D350D, D350E							
STEERING							
	7U2910		I-U-5	2	4-1/2	CTC-6U9552	188.77
SUSPENSION							
	2U8060		I-U-10	4	4-1/2	CTC-1045008	235.48
	7U7198		I-U-10	4	4-1/2	CTC-1045008	235.48
SUSPENSION REAR							
	7U9538		I-UB-10	2	4-1/2	CTC-7U9545	261.36
UNSPECIFIED APPLICATION							
	5U7773		I-U-3	3-1/2	5-1/2	CTC-5U7775	272.25
	7U2476		I-U-10	4	4-1/2	CTC-7U2486	273.10
MODEL D400							
HOIST							
	5U7773		I-U-3	3-1/2	5-1/2	CTC-5U7775	272.25
STEERING							
	6U1040		I-U-5	2	4-1/2	CTC-6U9552	188.77
	7U2910		I-U-5	2	4-1/2	CTC-6U9552	188.77
MODEL D400D							
STEERING							
	7U2910		I-U-5	2	4-1/2	CTC-6U9552	188.77
SUSPENSION							
	1049660		P-UB-10	3-1/2	4-1/2	CTC-1942756	279.63
	2U8060		I-U-10	4	4-1/2	CTC-1045008	235.48
	7U7198		I-U-10	4	4-1/2	CTC-1045008	235.48
SUSPENSION REAR							
	7U9538		I-UB-10	2	4-1/2	CTC-7U9545	261.36
MODEL D400E							
HOIST							
	1434850		P-UB-10	3-1/2	5-1/2	CTC-1890263	207.99

CATERPILLAR®



REPLACEMENT KITS FOR CATERPILLAR® EQUIPMENT

Articulated Dump Trucks							
APPLICATION	CYL #	Misc-Parts, Instructions, etc.	CODE	ROD	BORE	KIT #	List \$
MODEL D400E							
STEERING							
	1433299		I-UB-10	2	4-1/2	CTC-1857699	182.06
	1453620		P-UB-10	2	4-1/2	CTC-1857700	82.16
	7U2910		I-U-5	2	4-1/2	CTC-6U9552	188.77
SUSPENSION							
	1049660		P-UB-10	3-1/2	4-1/2	CTC-1942756	279.63
	2U8060		I-U-10	4	4-1/2	CTC-1045008	235.48
	7U7198		I-U-10	4	4-1/2	CTC-1045008	235.48
SUSPENSION REAR							
	7U9538		I-UB-10	2	4-1/2	CTC-1857699	182.06
UNSPECIFIED APPLICATION							
	1331584		P-UB-10	4	4-1/2	CTC-1944398	194.17
	1511179		P-UB-10	3-1/2	4-1/2	CTC-1944399	206.79
	1512611		P-UB-10	2	3	CTC-1857667	71.63
	5U7773		I-U-3	3-1/2	5-1/2	CTC-5U7775	272.25
	7U2476		I-U-10	4	4-1/2	CTC-7U2486	273.10
Backhoe-Loaders							
APPLICATION	CYL #	Misc-Parts, Instructions, etc.	CODE	ROD	BORE	KIT #	List \$
MODEL 416							
BACKHOE BOOM							
	4T6878		P-UB-10	1-7/8	3-1/4	CTC-8T3589	68.36
	6E0087		P-UB-10	1-7/8	3-1/4	CTC-3E3297	83.37
	9T5219		P-UB-10	1-7/8	3-1/4	CTC-3E3297	83.37
BACKHOE BUCKET							
	4T5601		P-UB-10	2	3-1/4	CTC-7X2821	118.51
	6E0091		I-UB-10	2-1/2	3-1/2	CTC-3E3299	113.42
	9T2751		P-UB-10	2	3-1/4	CTC-7X2821	118.51
	9T7287		I-UB-10	2-1/2	3-1/2	CTC-3E3299	113.42
	9T7893		P-UB-10	2	3-1/4	CTC-7X2821	118.51
	9T7894		P-UB-10	2	3-1/4	CTC-7X2821	118.51
BACKHOE EXT STICK							
	9T2215		P-UB-10	1-1/2	3	CTC-7X2745	91.86
	9T4809		P-UB-10	1-1/2	3	CTC-7X2737	91.86
	9T7893		P-UB-10	2	3-1/4	CTC-7X2821	118.51
BACKHOE STICK							
	4T6877		P-UB-10	2-1/8	4	CTC-1305923	134.10
	6E0089		P-UB-10	2-1/2	4-1/4	CTC-3E3300	90.91
	9T2215		P-UB-10	1-1/2	3	CTC-7X2737	91.86
	9T5216		P-UB-10	2-1/8	4	CTC-1305923	134.10
	9T7063		P-UB-10	2-1/8	4	CTC-1305923	134.10
	9T7291		P-UB-10	2-1/2	4-1/4	CTC-3E3300	90.91
BACKHOE SWING							
	4T6879		P-UB-10	2-1/8	4	CTC-1305923	134.10
	6E0093		P-UB-10	2-1/8	4	CTC-1305923	134.10
BACKHOE SWING LH							
	4T6879		P-UB-10	2-1/8	4	CTC-8T3593	60.05



REPLACEMENT KITS FOR CATERPILLAR® EQUIPMENT

Backhoe-Loaders							
APPLICATION	CYL #	Misc-Parts, Instructions, etc.	CODE	ROD	BORE	KIT #	List \$
MODEL 416							
BACKHOE SWING RH							
	9T0529		P-UB-10	2-1/8	4	CTC-1305923	134.10
LOADER BUCKET MP							
	9T4006		P-UB-10	1-1/2	3	CTC-7X2737	91.86
LOADER LIFT							
	6E0103		P-UB-10	1-7/8	3-1/4	CTC-3E3297	83.37
	9T0415		P-UB-10	1-7/8	3-1/4	CTC-3E3297	83.37
LOADER TILT							
	6E0105		P-UB-10	1-7/8	3-1/4	CTC-3E3297	83.37
	9T0414		P-UB-10	1-7/8	3-1/4	CTC-8T3589	68.36
	9T4005		P-UB-10	1-7/8	3-1/4	CTC-3E3297	83.37
	9T5370		P-UB-10	1-7/8	3-1/4	CTC-3E3297	83.37
STABILIZER							
	9T7391		P-UB-10	2-1/8	4	CTC-1305923	134.10
	9T7392		P-UB-10	2-1/8	4	CTC-1305923	134.10
STABILIZER LH							
	4T9911		P-UB-10	2-1/8	4	CTC-1305923	134.10
	6E0097		P-UB-10	2-1/8	4	CTC-1305923	134.10
	9T7070		P-UB-10	2-1/8	4	CTC-1305923	134.10
STABILIZER RH							
	4T6880		P-UB-10	2-1/8	4	CTC-1305923	134.10
	6E0099		P-UB-10	2-1/8	4	CTC-1305923	134.10
	9T7069		P-UB-10	2-1/8	4	CTC-1305923	134.10
STEERING							
	6E5190		P-UB-10	1-7/8	3	CTC-1113301	110.82
	9T1493		P-UB-10	1-7/8	3	CTC-8T3852	163.17
UNSPECIFIED APPLICATION							
	1070624		P-UB-10	1-7/8	3-1/4	CTC-3E3297	83.37
	1070625		P-UB-10	1-7/8	3-1/4	CTC-3E3297	83.37
MODEL 416B							
BACKHOE BOOM							
	6E0274		P-UB-10	2-3/8	4-1/2	CTC-3E8877	150.30
BACKHOE BUCKET							
	1268308		I-UB-10	2-1/2	3-1/2	CTC-3E3299	113.42
	6E0275		I-UB-10	2-1/2	3-1/2	CTC-3E3299	113.42
BACKHOE EXT BUCKET							
	6E1964		I-UB-10	2-1/2	3-1/2	CTC-3E3299	113.42
BACKHOE STICK							
	1065694	Rod Bearing width- 1.25"	P-UB-10	2-1/2	4-1/2	CTC-1469860	136.41
	1097020		P-UB-10	2-1/2	4-1/2	CTC-1113300	115.52
	1097021		P-UB-10	2-1/2	4-1/2	CTC-1113300	115.52
	6E0290	Rod Bearing width- 1.25"	P-UB-10	2-1/2	4-1/2	CTC-1469860	136.41
	6E0404		P-UB-10	1-1/2	3	CTC-7X2737	91.86
BACKHOE SWING							
	1166861		P-UB-10	2	4	CTC-1113302	100.62
	6E0288		P-UB-10	2	4	CTC-1113302	100.62
	6E1864		P-UB-10	2	4	CTC-1328816	78.46

CATERPILLAR®



REPLACEMENT KITS FOR CATERPILLAR® EQUIPMENT

Backhoe-Loaders							
APPLICATION	CYL #	Misc-Parts, Instructions, etc.	CODE	ROD	BORE	KIT #	List \$
MODEL 416B							
LOADER BUCKET MP							
	9T4006		P-UB-10	1-1/2	3	CTC-7X2737	91.86
LOADER LIFT							
	9T0415		P-UB-10	1-7/8	3-1/4	CTC-3E3297	83.37
LOADER TILT							
	6E0105		P-UB-10	1-7/8	3-1/4	CTC-3E3297	83.37
	9T5490		P-UB-10	1-7/8	3-1/4	CTC-3E3297	83.37
STABILIZER							
	1052323		P-UB-10	2-1/8	4	CTC-1305923	134.10
	1052358		P-UB-10	2-1/8	4	CTC-1305923	134.10
	9T2993		P-UB-10	2-1/8	4	CTC-9X2400	100.80
	9T2994		P-UB-10	2-1/8	4	CTC-9X2400	100.80
STABILIZER LH							
	1165354		P-UB-10	2-1/8	4	CTC-8T3593	60.05
	1302364		P-UB-10	2-1/8	4	CTC-1305923	134.10
	6E0097		P-UB-10	2-1/8	4	CTC-1305923	134.10
STABILIZER RH							
	1165353		P-UB-10	2-1/8	4	CTC-1305923	134.10
	1302365		P-UB-10	2-1/8	4	CTC-1305923	134.10
	6E0099		P-UB-10	2-1/8	4	CTC-1305923	134.10
STEERING							
	6E5190		P-UB-10	1-7/8	3	CTC-1113301	110.82
UNSPECIFIED APPLICATION							
	1070624		P-UB-10	1-7/8	3-1/4	CTC-3E3297	83.37
	1070625		P-UB-10	1-7/8	3-1/4	CTC-3E3297	83.37
	1165354		P-UB-10	2-1/8	4	CTC-1305923	134.10
MODEL 416C							
BACKHOE BOOM							
	6E0274		P-UB-10	2-3/8	4-1/2	CTC-3E8877	150.30
BACKHOE BUCKET							
	1268308		I-UB-10	2-1/2	3-1/2	CTC-3E3299	113.42
BACKHOE EXT BUCKET							
	6E1964		I-UB-10	2-1/2	3-1/2	CTC-3E3299	113.42
BACKHOE STICK							
	1097020		P-UB-10	2-1/2	4-1/2	CTC-1113300	115.52
	6E0404		P-UB-10	1-1/2	3	CTC-7X2737	91.86
BACKHOE SWING							
	1166857		P-UB-10	2	4	CTC-1113302	100.62
LOADER BUCKET MP							
	9T4006		P-UB-10	1-1/2	3	CTC-7X2737	91.86
LOADER TILT							
	6E0105		P-UB-10	1-7/8	3-1/4	CTC-3E3297	83.37
STABILIZER LH							
	1311846		P-UB-10	2-1/8	4	CTC-1305923	134.10
	1521806		P-UB-10	2-1/8	4	CTC-1305923	134.10



REPLACEMENT KITS FOR CATERPILLAR® EQUIPMENT

Backhoe-Loaders							
APPLICATION	CYL #	Misc-Parts, Instructions, etc.	CODE	ROD	BORE	KIT #	List \$
MODEL 416C							
STABILIZER RH							
	1311847		P-UB-10	2-1/8	4	CTC-1305923	134.10
	1521796		P-UB-10	2-1/8	4	CTC-1305923	134.10
STEERING							
	1156437		P-UB-10	1-3/4	2-1/2	CTC-1539054	122.06
UNSPECIFIED APPLICATION							
	1070624		P-UB-10	1-7/8	3-1/4	CTC-3E3297	83.37
	1070625		P-UB-10	1-7/8	3-1/4	CTC-3E3297	83.37
	1235087		P-UB-10	2	3-1/2	CTC-7X2783	87.11
	1235091		P-UB-10	2	3	CTC-7X2760	54.39
	9T8823		I-O-3	1	2	CTC-9T0418	70.20
MODEL 420D							
BACKHOE BOOM							
	1529148		P-UB-10	2-3/8	4-3/4	CTC-2350973	130.07
BACKHOE BUCKET							
	1668140		I-UB-10	2-3/4	3-3/4	CTC-2235944	67.02
BACKHOE EXT BUCKET							
	1668141		I-UB-10	2-3/4	3-3/4	CTC-2235944	67.02
BACKHOE EXT STICK							
	1647174		P-UB-10	1-1/2	3	CTC-2350354	29.07
BACKHOE STICK							
	1843709		P-UB-10	2-1/2	4-1/2	CTC-2435805	95.97
BACKHOE SWING							
	1699529		P-UB-10	2	4	CTC-1113302	100.62
LOADER BUCKET MP							
	1851839		P-UB-10	1-1/2	3	CTC-2350354	29.07
LOADER LIFT							
	1807490		P-UB-10	2	85 mm	CTC-2410110	96.93
	1832856		P-UB-10	2	85 mm	CTC-2410110	96.93
LOADER TILT							
	1807482		P-UB-10	2	85 mm	CTC-2410110	96.93
	1832848		P-UB-10	2	75 mm	CTC-2410109	71.67
STEERING							
	1674235	ENG 03-UP	P-UB-10	1-3/4	2-3/4	CTC-2350351	122.66
	1674235	ENG 00-02	P-UB-10	1-3/4	2-3/4	CTC-2350352	85.15
MODEL 426							
BACKHOE BACKHOE BOOM							
	4T6969		P-UB-10	2-1/8	3-1/2	CTC-8T3591	88.74
	6E0109		P-UB-10	2	3-1/2	CTC-7X2783	87.11
BACKHOE BOOM							
	9T5222		P-UB-10	2	3-1/2	CTC-7X2822	80.82

CATERPILLAR®



REPLACEMENT KITS FOR CATERPILLAR® EQUIPMENT

Backhoe-Loaders							
APPLICATION	CYL #	Misc-Parts, Instructions, etc.	CODE	ROD	BORE	KIT #	List \$
MODEL 426							
BACKHOE BUCKET							
	4T5601		P-UB-10	2	3-1/4	CTC-7X2821	118.51
	6E0091		I-UB-10	2-1/2	3-1/2	CTC-3E3299	113.42
	9T0735		P-UB-10	2	3-1/2	CTC-7X2822	80.82
	9T2751		P-UB-10	2	3-1/4	CTC-7X2821	118.51
	9T7287		I-UB-10	2-1/2	3-1/2	CTC-3E3299	113.42
	9T7894		P-UB-10	2	3-1/4	CTC-7X2821	118.51
BACKHOE EXT STICK							
	9T2215		P-UB-10	1-1/2	3	CTC-7X2737	91.86
	9T2215		P-UB-10	1-1/2	3	CTC-7X2745	91.86
	9T2215		P-UB-10	1-1/2	3	CTC-7X2745	91.86
	9T4809		P-UB-10	1-1/2	3	CTC-7X2737	91.86
	9T7893		P-UB-10	2	3-1/4	CTC-7X2821	118.51
BACKHOE STICK							
	4T6968		P-UB-10	2-1/8	4	CTC-1305923	134.10
	6E0111		P-UB-10	2-1/2	4-1/4	CTC-3E3300	90.91
	9T2215		P-UB-10	1-1/2	3	CTC-7X2737	91.86
	9T5220		P-UB-10	2-1/8	4	CTC-1305923	134.10
	9T7066		P-UB-10	2-1/8	4	CTC-1305923	134.10
	9T7289		P-UB-10	2-1/2	4-1/4	CTC-3E3300	90.91
BACKHOE SWING							
	6E0093		P-UB-10	2-1/8	4	CTC-1305923	134.10
BACKHOE SWING LH							
	4T6879		P-UB-10	2-1/8	4	CTC-1305923	134.10
BACKHOE SWING RH							
	9T0529		P-UB-10	2-1/8	4	CTC-1305923	134.10
LOADER BUCKET MP							
	9T4006		P-UB-10	1-1/2	3	CTC-7X2737	91.86
LOADER LIFT							
	6E0103		P-UB-10	1-7/8	3-1/4	CTC-3E3297	83.37
	9T0415		P-UB-10	1-7/8	3-1/4	CTC-3E3297	83.37
LOADER TILT							
	6E0113		P-UB-10	2	3-1/2	CTC-7X2783	87.11
	9T0735		P-UB-10	2	3-1/2	CTC-7X2822	80.82
	9T5370		P-UB-10	1-7/8	3-1/4	CTC-8T3589	68.36
	9T5371		P-UB-10	2	3-1/2	CTC-7X2783	87.11
	9T5371		P-UB-10	2	3-1/2	CTC-7X2822	80.82
STABILIZER							
	9T7391		P-UB-10	2-1/8	4	CTC-1305923	134.10
	9T7392		P-UB-10	2-1/8	4	CTC-1305923	134.10
STABILIZER LH							
	4T9911		P-UB-10	2-1/8	4	CTC-1305923	134.10
	6E0097		P-UB-10	2-1/8	4	CTC-1305923	134.10
	9T7070		P-UB-10	2-1/8	4	CTC-1305923	134.10



REPLACEMENT KITS FOR CATERPILLAR® EQUIPMENT

Backhoe-Loaders							
APPLICATION	CYL #	Misc-Parts, Instructions, etc.	CODE	ROD	BORE	KIT #	List \$
MODEL 426							
STABILIZER RH							
	4T6880		P-UB-10	2-1/8	4	CTC-1305923	134.10
	6E0099		P-UB-10	2-1/8	4	CTC-1305923	134.10
	9T7069		P-UB-10	2-1/8	4	CTC-1305923	134.10
STEERING							
	6E5190		P-UB-10	1-7/8	3	CTC-1113301	110.82
	9T1493		P-UB-10	1-7/8	3	CTC-8T3852	163.17
UNSPECIFIED APPLICATION							
	1070624		P-UB-10	1-7/8	3-1/4	CTC-3E3297	83.37
MODEL 426B							
BACKHOE BACKHOE BOOM							
	6E1948		P-UB-10	2-1/2	5	CTC-1361967	163.90
BACKHOE BUCKET							
	1268316		I-UB-10	2-3/4	3-3/4	CTC-9X2020	92.07
	6E1809		I-UB-10	2-3/4	3-3/4	CTC-9X2020	92.07
BACKHOE EXT BUCKET							
	6E3692		I-UB-10	2-3/4	3-3/4	CTC-9X2020	92.07
BACKHOE STICK							
	6E1935		P-UB-10	2-3/4	5	CTC-3E8878	154.05
	6E3662		P-UB-10	1-1/2	3	CTC-7X2737	91.86
BACKHOE SWING							
	1166861		P-UB-10	2	4	CTC-1113302	100.62
	6E0288		P-UB-10	2	4	CTC-1113302	100.62
	6E1864		P-UB-10	2	4	CTC-1328816	78.46
LOADER BUCKET MP							
	9T4006		P-UB-10	1-1/2	3	CTC-7X2737	91.86
LOADER LIFT							
	6E0103		P-UB-10	1-7/8	3-1/4	CTC-3E3297	83.37
	9T0415		P-UB-10	1-7/8	3-1/4	CTC-3E3297	83.37
LOADER TILT							
	1071855		P-UB-10	2	3-1/2	CTC-7X2783	87.11
	6E0113		P-UB-10	2	3-1/2	CTC-7X2783	87.11
STABILIZER							
	1052323		P-UB-10	2-1/8	4	CTC-1305923	134.10
	1052358		P-UB-10	2-1/8	4	CTC-1305923	134.10
STABILIZER LH							
	1165354		P-UB-10	2-1/8	4	CTC-1305923	134.10
	1302364		P-UB-10	2-1/8	4	CTC-1305923	134.10
	6E0098		P-UB-10	2-1/8	4	CTC-1305923	134.10
STABILIZER RH							
	1165353		P-UB-10	2-1/8	4	CTC-1305923	134.10
	1302365		P-UB-10	2-1/8	4	CTC-1305923	134.10
	6E0099		P-UB-10	2-1/8	4	CTC-1305923	134.10
STEERING							
	6E5190		P-UB-10	1-7/8	3	CTC-1113301	110.82
UNSPECIFIED APPLICATION							
	1070624		P-UB-10	1-7/8	3-1/4	CTC-3E3297	83.37

CATERPILLAR®



REPLACEMENT KITS FOR CATERPILLAR® EQUIPMENT

Backhoe-Loaders							
APPLICATION	CYL #	Misc-Parts, Instructions, etc.	CODE	ROD	BORE	KIT #	List \$
MODEL 426C							
BACKHOE BOOM							
	6E1948		P-UB-10	2-1/2	5	CTC-1361967	163.90
BACKHOE BUCKET							
	1268316		I-UB-10	2-3/4	3-3/4	CTC-9X2020	92.07
BACKHOE EXT BUCKET							
	6E3692		I-UB-10	2-3/4	3-3/4	CTC-9X2020	92.07
BACKHOE STICK							
	1535735		P-UB-10	1-1/2	3	CTC-7X2737	91.86
	6E1935		P-UB-10	2-3/4	5	CTC-3E8878	154.05
	6E3662		P-UB-10	1-1/2	3	CTC-7X2737	91.86
BACKHOE SWING							
	1166861		P-UB-10	2	4	CTC-1113302	100.62
LOADER BUCKET MP							
	9T4006		P-UB-10	1-1/2	3	CTC-7X2737	91.86
LOADER LIFT							
	1108688		P-UB-10	2	3-1/2	CTC-7X2783	87.11
	1216764		P-UB-10	2	3-1/2	CTC-7X2783	87.11
LOADER TILT							
	1071855		P-UB-10	2	3-1/2	CTC-7X2783	87.11
STABILIZER LH							
	1311846		P-UB-10	2-1/8	4	CTC-1305923	134.10
	1521806		P-UB-10	2-1/8	4	CTC-1305923	134.10
STABILIZER RH							
	1311847		P-UB-10	2-1/8	4	CTC-1305923	134.10
	1521796		P-UB-10	2-1/8	4	CTC-1305923	134.10
STEERING							
	1156437		P-UB-10	1-3/4	2-1/2	CTC-1539054	122.06
UNSPECIFIED APPLICATION							
	1235087		P-UB-10	2	3-1/2	CTC-7X2783	87.11
	1235091		P-UB-10	2	3	CTC-7X2760	54.39
	9T8823		I-O-3	1	2	CTC-9T0418	70.20
MODEL 428							
BACKHOE BOOM							
	4T6878		P-UB-10	1-7/8	3-1/4	CTC-8T3589	68.36
	4T6969		P-UB-10	2-1/8	3-1/2	CTC-8T3591	88.74
	6E0087		P-UB-10	1-7/8	3-1/4	CTC-3E3297	83.37
	9T5219		P-UB-10	1-7/8	3-1/4	CTC-3E3297	83.37
	9T5219		P-UB-10	1-7/8	3-1/4	CTC-8T3589	68.36
BACKHOE BUCKET							
	4T5601		P-UB-10	2	3-1/4	CTC-7X2821	118.51
	6E0091		I-UB-10	2-1/2	3-1/2	CTC-3E3299	113.42
	9T2751		P-UB-10	2	3-1/4	CTC-7X2821	118.51
	9T7287		I-UB-10	2-1/2	3-1/2	CTC-3E3299	113.42
	9T7893		P-UB-10	2	3-1/4	CTC-7X2821	118.51
	9T7894		P-UB-10	2	3-1/4	CTC-7X2821	118.51



REPLACEMENT KITS FOR CATERPILLAR® EQUIPMENT

Backhoe-Loaders							
APPLICATION	CYL #	Misc-Parts, Instructions, etc.	CODE	ROD	BORE	KIT #	List \$
MODEL 428							
BACKHOE EXT STICK							
	9T2215		P-UB-10	1-1/2	3	CTC-7X2745	91.86
	9T4809		P-UB-10	1-1/2	3	CTC-7X2737	91.86
	9T7893		P-UB-10	2	3-1/4	CTC-7X2821	118.51
BACKHOE STICK							
	4T6877		P-UB-10	2-1/8	4	CTC-8T3593	60.05
	4T6893		P-UB-10	2-1/8	4	CTC-1305923	134.10
	6E0089		P-UB-10	2-1/2	4-1/4	CTC-3E3300	90.91
	9T2214		P-UB-10	1-1/2	3	CTC-7X2737	91.86
	9T2762		P-UB-10	2-1/8	4	CTC-8T3593	60.05
	9T5215		P-UB-10	2-1/8	4	CTC-1305923	134.10
	9T5216		P-UB-10	2-1/8	4	CTC-8T3593	60.05
	9T5216		P-UB-10	2-1/8	4	CTC-8T3593	60.05
	9T7063		P-UB-10	2-1/8	4	CTC-1305923	134.10
	9T7291		P-UB-10	2-1/2	4-1/4	CTC-3E3300	90.91
BACKHOE SWING							
	9T0420		P-UB-10	2-1/8	4	CTC-8T3593	60.05
	9T0421		P-UB-10	2-1/8	4	CTC-8T3593	60.05
BACKHOE SWING LH							
	9T0421		P-UB-10	2-1/8	4	CTC-1305923	134.10
BACKHOE SWING RH							
	9T0420		P-UB-10	2-1/8	4	CTC-1305923	134.10
LOADER BUCKET MP							
	9T4006		P-UB-10	1-1/2	3	CTC-7X2737	91.86
LOADER LIFT							
	6E0103		P-UB-10	1-7/8	3-1/4	CTC-3E3297	83.37
	9T0415		P-UB-10	1-7/8	3-1/4	CTC-3E3297	83.37
LOADER TILT							
	6E0113		P-UB-10	2	3-1/2	CTC-7X2783	87.11
	9T0735		P-UB-10	2	3-1/2	CTC-7X2822	80.82
	9T0770		P-UB-10	2	3-1/2	CTC-7X2783	87.11
	9T5370		P-UB-10	1-7/8	3-1/4	CTC-8T3589	68.36
	9T5371		P-UB-10	2	3-1/2	CTC-7X2783	87.11
	9T5371		P-UB-10	2	3-1/2	CTC-7X2822	80.82
STABILIZER							
	6E0119		P-UB-10	1-3/4	2-3/4	CTC-1539053	127.54
	9T0527		P-UB-10	1-3/4	2-3/4	CTC-7X2820	66.93
	9T9709		P-UB-10	1-3/4	2-3/4	CTC-7X2820	66.93
STEERING							
	9T1493		P-UB-10	1-7/8	3	CTC-8T3852	163.17
UNSPECIFIED APPLICATION							
	1070624		P-UB-10	1-7/8	3-1/4	CTC-3E3297	83.37
MODEL 428B							
BACKHOE BOOM							
	6E0274		P-UB-10	2-3/8	4-1/2	CTC-3E8877	150.30

CATERPILLAR®



REPLACEMENT KITS FOR CATERPILLAR® EQUIPMENT

Backhoe-Loaders							
APPLICATION	CYL #	Misc-Parts, Instructions, etc.	CODE	ROD	BORE	KIT #	List \$
MODEL 428B							
BACKHOE BUCKET							
	1268308		I-UB-10	2-1/2	3-1/2	CTC-3E3299	113.42
	6E0275		I-UB-10	2-1/2	3-1/2	CTC-3E3299	113.42
BACKHOE EXT BUCKET							
	6E1964		I-UB-10	2-1/2	3-1/2	CTC-3E3299	113.42
	6E2421		I-UB-10	2-3/4	3-3/4	CTC-9X2020	92.07
BACKHOE STICK							
	1097021		P-UB-10	2-1/2	4-1/2	CTC-1113300	115.52
	6E0290		P-UB-10	2-1/2	4-1/2	CTC-1113300	115.52
	6E0290	Rod Bearing width- 1.25"	P-UB-10	2-1/2	4-1/2	CTC-1469860	136.41
	6E0404		P-UB-10	1-1/2	3	CTC-7X2737	91.86
BACKHOE SWING							
	1166861		P-UB-10	2	4	CTC-1113302	100.62
	6E0288		P-UB-10	2	4	CTC-1113302	100.62
BACKHOE SWING LH							
	1166858		P-UB-10	2	4	CTC-1113302	100.62
	6E1864		P-UB-10	2	4	CTC-1113302	100.62
LOADER BUCKET MP							
	9T4006		P-UB-10	1-1/2	3	CTC-7X2737	91.86
LOADER LIFT							
	6E0103		P-UB-10	1-7/8	3-1/4	CTC-3E3297	83.37
	9T0415		P-UB-10	1-7/8	3-1/4	CTC-3E3297	83.37
LOADER TILT							
	1071855		P-UB-10	2	3-1/2	CTC-7X2783	87.11
	6E0113		P-UB-10	2	3-1/2	CTC-7X2783	87.11
SIDESHIFT							
	1166858		P-UB-10	2	4	CTC-1113302	100.62
SIDESHIFT RH							
	1166858		P-UB-10	2	4	CTC-1113302	100.62
STABILIZER							
	1266950		P-UB-10	1-3/4	2-3/4	CTC-1539053	127.54
	6E3483		P-UB-10	1-3/4	2-3/4	CTC-1539053	127.54
STEERING							
	6E5190		P-UB-10	1-7/8	3	CTC-1113301	110.82
UNSPECIFIED APPLICATION							
	1070624		P-UB-10	1-7/8	3-1/4	CTC-3E3297	83.37
MODEL 428C							
BACKHOE BOOM							
	6E0274		P-UB-10	2-3/8	4-1/2	CTC-3E8877	150.30
BACKHOE BUCKET							
	1268308		I-UB-10	2-1/2	3-1/2	CTC-3E3299	113.42
	1268312		I-UB-10	2-3/4	3-3/4	CTC-1361990	147.09
	6E0275		I-UB-10	2-1/2	3-1/2	CTC-3E3299	113.42
BACKHOE EXT BUCKET							
	6E1964		I-UB-10	2-1/2	3-1/2	CTC-3E3299	113.42



REPLACEMENT KITS FOR CATERPILLAR® EQUIPMENT

Backhoe-Loaders							
APPLICATION	CYL #	Misc-Parts, Instructions, etc.	CODE	ROD	BORE	KIT #	List \$
MODEL 428C							
BACKHOE STICK							
	1097021		P-UB-10	2-1/2	4-1/2	CTC-1113300	115.52
	6E0404		P-UB-10	1-1/2	3	CTC-7X2737	91.86
BACKHOE SWING							
	1166861		P-UB-10	2	4	CTC-1113302	100.62
LOADER BUCKET MP							
	9T4006		P-UB-10	1-1/2	3	CTC-7X2737	91.86
LOADER TILT							
	1071855		P-UB-10	2	3-1/2	CTC-7X2783	87.11
SIDESHIFT							
	1166858		P-UB-10	2	4	CTC-1113302	100.62
SIDESHIFT RH							
	1166858		P-UB-10	2	4	CTC-1113302	100.62
STABILIZER							
	1266950		P-UB-10	1-3/4	2-3/4	CTC-1539053	127.54
STEERING							
	1156437		P-UB-10	1-3/4	2-1/2	CTC-1539054	122.06
UNSPECIFIED APPLICATION							
	1070624		P-UB-10	1-7/8	3-1/4	CTC-3E3297	83.37
	1235087		P-UB-10	2	3-1/2	CTC-7X2783	87.11
	1235091		P-UB-10	2	3	CTC-7X2760	54.39
	9T8823		I-O-3	1	2	CTC-9T0418	70.20
MODEL 436							
BACKHOE BOOM							
	6E0109		P-UB-10	2	3-1/2	CTC-7X2783	87.11
	9T5222		P-UB-10	2	3-1/2	CTC-7X2783	87.11
	9T5222		P-UB-10	2	3-1/2	CTC-7X2822	80.82
BACKHOE EXT STICK							
	9T4809		P-UB-10	1-1/2	3	CTC-7X2737	91.86
BACKHOE SWING							
	4T6879		P-UB-10	2-1/8	4	CTC-1305923	134.10
	6E0093		P-UB-10	2-1/8	4	CTC-1305923	134.10
BACKHOE SWING LH							
	4T6879		P-UB-10	2-1/8	4	CTC-8T3593	60.05
BACKHOE SWING RH							
	9T0529		P-UB-10	2-1/8	4	CTC-1305923	134.10
LOADER BUCKET MP							
	9T4006		P-UB-10	1-1/2	3	CTC-7X2737	91.86
LOADER LIFT							
	6E0103		P-UB-10	1-7/8	3-1/4	CTC-3E3297	83.37
	9T0415		P-UB-10	1-7/8	3-1/4	CTC-3E3297	83.37
LOADER TILT							
	6E0113		P-UB-10	2	3-1/2	CTC-7X2783	87.11
	9T5371		P-UB-10	2	3-1/2	CTC-7X2783	87.11
	9T5371		P-UB-10	2	3-1/2	CTC-7X2822	80.82

CATERPILLAR®



REPLACEMENT KITS FOR CATERPILLAR® EQUIPMENT

Backhoe-Loaders							
APPLICATION	CYL #	Misc-Parts, Instructions, etc.	CODE	ROD	BORE	KIT #	List \$
MODEL 436							
STABILIZER							
	9T7391		P-UB-10	2-1/8	4	CTC-1305923	134.10
	9T7392		P-UB-10	2-1/8	4	CTC-1305923	134.10
STABILIZER LH							
	6E0097		P-UB-10	2-1/8	4	CTC-1305923	134.10
	9T7070		P-UB-10	2-1/8	4	CTC-1305923	134.10
STABILIZER RH							
	6E0099		P-UB-10	2-1/8	4	CTC-1305923	134.10
	9T7069		P-UB-10	2-1/8	4	CTC-1305923	134.10
STEERING							
	6E5190		P-UB-10	1-7/8	3	CTC-1113301	110.82
	9T1493		P-UB-10	1-7/8	3	CTC-8T3852	163.17
UNSPECIFIED APPLICATION							
	1070624		P-UB-10	1-7/8	3-1/4	CTC-3E3297	83.37
MODEL 436B							
BACKHOE BOOM							
	6E0274		P-UB-10	2-3/8	4-1/2	CTC-3E8877	150.30
	6E1948		P-UB-10	2-1/2	5	CTC-1361967	163.90
BACKHOE BUCKET							
	1268316		I-UB-10	2-3/4	3-3/4	CTC-9X2020	92.07
	6E0275		I-UB-10	2-1/2	3-1/2	CTC-3E3299	113.42
	6E1809		I-UB-10	2-3/4	3-3/4	CTC-9X2020	92.07
BACKHOE EXT BUCKET							
	6E3692		I-UB-10	2-3/4	3-3/4	CTC-9X2020	92.07
BACKHOE STICK							
	6E1935		P-UB-10	2-3/4	5	CTC-3E8878	154.05
	6E3662		P-UB-10	1-1/2	3	CTC-7X2737	91.86
BACKHOE SWING							
	1166861		P-UB-10	2	4	CTC-1113302	100.62
	6E0288		P-UB-10	2	4	CTC-1113302	100.62
	6E1864		P-UB-10	2	4	CTC-1328816	78.46
LOADER BUCKET MP							
	9T4006		P-UB-10	1-1/2	3	CTC-7X2737	91.86
LOADER LIFT							
	6E0103		P-UB-10	1-7/8	3-1/4	CTC-3E3297	83.37
	9T0415		P-UB-10	1-7/8	3-1/4	CTC-3E3297	83.37
LOADER TILT							
	1071855		P-UB-10	2	3-1/2	CTC-7X2783	87.11
	6E0113		P-UB-10	2	3-1/2	CTC-7X2783	87.11
STABILIZER							
	1052323		P-UB-10	2-1/8	4	CTC-1305923	134.10
	1052358		P-UB-10	2-1/8	4	CTC-1305923	134.10
	9T2993		P-UB-10	2-1/8	4	CTC-9X2400	100.80
	9T2994		P-UB-10	2-1/8	4	CTC-9X2400	100.80



REPLACEMENT KITS FOR CATERPILLAR® EQUIPMENT

Backhoe-Loaders							
APPLICATION	CYL #	Misc-Parts, Instructions, etc.	CODE	ROD	BORE	KIT #	List \$
MODEL 436B							
STABILIZER LH							
	1165354		P-UB-10	2-1/8	4	CTC-1305923	134.10
	1302364		P-UB-10	2-1/8	4	CTC-1305923	134.10
	6E0097		P-UB-10	2-1/8	4	CTC-1305923	134.10
STABILIZER RH							
	1165353		P-UB-10	2-1/8	4	CTC-1305923	134.10
	1302365		P-UB-10	2-1/8	4	CTC-1305923	134.10
	6E0099		P-UB-10	2-1/8	4	CTC-1305923	134.10
	9T7069		P-UB-10	2-1/8	4	CTC-8T3593	60.05
STEERING							
	6E5190		P-UB-10	1-7/8	3	CTC-1113301	110.82
UNSPECIFIED APPLICATION							
	1070624		P-UB-10	1-7/8	3-1/4	CTC-3E3297	83.37
MODEL 436C							
BACKHOE BOOM							
	1118211		P-UB-10	2-5/8	5-1/4	CTC-1361908	149.58
	6E1948		P-UB-10	2-1/2	5	CTC-1361967	163.90
BACKHOE BUCKET							
	1118216		I-UB-10	2-3/4	3-3/4	CTC-9X2020	92.07
	1268316		I-UB-10	2-3/4	3-3/4	CTC-9X2020	92.07
	9T6305		I-UB-10	2-3/4	3-3/4	CTC-9X2020	92.07
BACKHOE EXT BUCKET							
	1144828		I-UB-10	2-3/4	3-3/4	CTC-9X2020	92.07
	6E3692		I-UB-10	2-3/4	3-3/4	CTC-9X2020	92.07
	9T4760		I-UB-10	2-3/4	3-3/4	CTC-9X2020	92.07
BACKHOE EXT STICK							
	6E5383		P-UB-10	1-3/4	3	CTC-7X2825	42.17
BACKHOE STICK							
	1118213		P-UB-10	3	5-1/4	CTC-3E3293	150.34
	1239707		P-UB-10	1-3/4	3	CTC-7X2825	42.17
	1535735		P-UB-10	1-1/2	3	CTC-7X2737	91.86
	6E1936		P-UB-10	2-3/4	5	CTC-3E8878	154.05
	6E3062		P-UB-10	3	5-1/4	CTC-3E3293	150.34
	6E3314		P-UB-10	3	5-1/4	CTC-3E3293	150.34
	6E3662		P-UB-10	1-1/2	3	CTC-7X2737	91.86
	9T8823		I-O-3	1	2	CTC-9T0418	70.20
	9T9186		P-UB-10	3	5-1/4	CTC-3E3293	150.34
BACKHOE SWING							
	1121765		P-UB-10	2	4	CTC-1113302	100.62
	1166861		P-UB-10	2	4	CTC-1113302	100.62
	6E5219		P-UB-10	2	4	CTC-1113302	100.62
BACKHOE SWING LH							
	9T1701		P-UB-10	2-1/8	4	CTC-9X2400	100.80
BACKHOE SWING RH							
	9T1230		P-UB-10	2-1/8	4	CTC-9X2400	100.80
LOADER BUCKET MP							
	9T4006		P-UB-10	1-1/2	3	CTC-7X2737	91.86

CATERPILLAR®



REPLACEMENT KITS FOR CATERPILLAR® EQUIPMENT

Backhoe-Loaders							
APPLICATION	CYL #	Misc-Parts, Instructions, etc.	CODE	ROD	BORE	KIT #	List \$
MODEL 436C							
LOADER LIFT							
	1108688		P-UB-10	2	3-1/2	CTC-7X2783	87.11
	1117712		P-UB-10	2-1/4	3-3/4	CTC-1361897	134.65
	1216764		P-UB-10	2	3-1/2	CTC-7X2783	87.11
	1257895		P-UB-10	2-1/4	3-3/4	CTC-1361897	134.65
	9T2997		P-UB-10	2	3-3/4	CTC-7X7938	88.49
LOADER TILT							
	1007844		P-UB-10	2	4	CTC-1328816	78.46
	1071855		P-UB-10	2	3-1/2	CTC-7X2783	87.11
	9T2995		P-UB-10	2	4	CTC-1328816	78.46
STABILIZER LH							
	1311846		P-UB-10	2-1/8	4	CTC-1305923	134.10
	1329701		P-UB-10	2-1/8	4	CTC-1305923	134.10
	1521806		P-UB-10	2-1/8	4	CTC-1305923	134.10
	9T2994		P-UB-10	2-1/8	4	CTC-1305923	134.10
STABILIZER RH							
	1311847		P-UB-10	2-1/8	4	CTC-1305923	134.10
	1329700		P-UB-10	2-1/8	4	CTC-1305923	134.10
	1521796		P-UB-10	2-1/8	4	CTC-1305923	134.10
	9T2993		P-UB-10	2-1/8	4	CTC-1305923	134.10
STEERING							
	1156437		P-UB-10	1-3/4	2-1/2	CTC-1539054	122.06
UNSPECIFIED APPLICATION							
	1235087		P-UB-10	2	3-1/2	CTC-7X2783	87.11
	1235091		P-UB-10	2	3	CTC-7X2760	54.39
MODEL 438							
BACKHOE BOOM							
	6E0087		P-UB-10	1-7/8	3-1/4	CTC-3E3297	83.37
	9T5219		P-UB-10	1-7/8	3-1/4	CTC-3E3297	83.37
	9T5219		P-UB-10	1-7/8	3-1/4	CTC-8T3589	68.36
BACKHOE BUCKET							
	4T5601		P-UB-10	2	3-1/4	CTC-7X2821	118.51
	9T2751		P-UB-10	2	3-1/4	CTC-7X2821	118.51
	9T7893		P-UB-10	2	3-1/4	CTC-7X2821	118.51
	9T7894		P-UB-10	2	3-1/4	CTC-7X2821	118.51
BACKHOE EXT STICK							
	9T2215		P-UB-10	1-1/2	3	CTC-7X2737	91.86
	9T2215		P-UB-10	1-1/2	3	CTC-7X2745	91.86
	9T2215		P-UB-10	1-1/2	3	CTC-7X2745	91.86
	9T4809		P-UB-10	1-1/2	3	CTC-7X2737	91.86
	9T4809		P-UB-10	1-1/2	3	CTC-7X2737	91.86
	9T7893		P-UB-10	2	3-1/4	CTC-7X2821	118.51
BACKHOE STICK							
	6E0089		P-UB-10	2-1/2	4-1/4	CTC-3E3300	90.91
	9T2215		P-UB-10	1-1/2	3	CTC-7X2737	91.86
	9T7291		P-UB-10	2-1/2	4-1/4	CTC-3E3300	90.91



REPLACEMENT KITS FOR CATERPILLAR® EQUIPMENT

Backhoe-Loaders							
APPLICATION	CYL #	Misc-Parts, Instructions, etc.	CODE	ROD	BORE	KIT #	List \$
MODEL 438							
BACKHOE SWING							
	9T0420		P-UB-10	2-1/8	4	CTC-8T3593	60.05
	9T0421		P-UB-10	2-1/8	4	CTC-8T3593	60.05
BACKHOE SWING LH							
	9T0421		P-UB-10	2-1/8	4	CTC-1305923	134.10
BACKHOE SWING RH							
	9T0420		P-UB-10	2-1/8	4	CTC-1305923	134.10
LOADER BUCKET MP							
	9T4006		P-UB-10	1-1/2	3	CTC-7X2737	91.86
LOADER LIFT							
	6E0103		P-UB-10	1-7/8	3-1/4	CTC-3E3297	83.37
	9T0415		P-UB-10	1-7/8	3-1/4	CTC-3E3297	83.37
LOADER TILT							
	6E0113		P-UB-10	2	3-1/2	CTC-7X2783	87.11
	9T5371		P-UB-10	2	3-1/2	CTC-7X2783	87.11
	9T5371		P-UB-10	2	3-1/2	CTC-7X2822	80.82
STABILIZER							
	6E0119		P-UB-10	1-3/4	2-3/4	CTC-1539053	127.54
	9T0527		P-UB-10	1-3/4	2-3/4	CTC-7X2820	66.93
	9T9709		P-UB-10	1-3/4	2-3/4	CTC-7X2820	66.93
STEERING							
	9T1493		P-UB-10	1-7/8	3	CTC-8T3852	163.17
UNSPECIFIED APPLICATION							
	1070624		P-UB-10	1-7/8	3-1/4	CTC-3E3297	83.37
MODEL 438B							
BACKHOE BOOM							
	6E0274		P-UB-10	2-3/8	4-1/2	CTC-3E8877	150.30
BACKHOE BUCKET							
	1268308		I-UB-10	2-1/2	3-1/2	CTC-3E3299	113.42
	1268312		I-UB-10	2-3/4	3-3/4	CTC-1361990	147.09
	6E0275		I-UB-10	2-1/2	3-1/2	CTC-3E3299	113.42
	6E3693		I-UB-10	2-3/4	3-3/4	CTC-1361990	147.09
BACKHOE EXT BUCKET							
	6E1964		I-UB-10	2-1/2	3-1/2	CTC-3E3299	113.42
	6E2421		I-UB-10	2-3/4	3-3/4	CTC-9X2020	92.07
BACKHOE STICK							
	1097021		P-UB-10	2-1/2	4-1/2	CTC-1113300	115.52
	6E0290		P-UB-10	2-1/2	4-1/2	CTC-1113300	115.52
	6E0290	Rod Bearing width- 1.25"	P-UB-10	2-1/2	4-1/2	CTC-1469860	136.41
	6E0404		P-UB-10	1-1/2	3	CTC-7X2737	91.86
BACKHOE SWING							
	1166861		P-UB-10	2	4	CTC-1113302	100.62
	6E0288		P-UB-10	2	4	CTC-1113302	100.62
BACKHOE SWING LH							
	6E1864		P-UB-10	2	4	CTC-1113302	100.62
LOADER BUCKET MP							
	9T4006		P-UB-10	1-1/2	3	CTC-7X2737	91.86

CATERPILLAR®



REPLACEMENT KITS FOR CATERPILLAR® EQUIPMENT

Backhoe-Loaders							
APPLICATION	CYL #	Misc-Parts, Instructions, etc.	CODE	ROD	BORE	KIT #	List \$
MODEL 438B							
LOADER LIFT							
	6E0103		P-UB-10	1-7/8	3-1/4	CTC-3E3297	83.37
	9T0415		P-UB-10	1-7/8	3-1/4	CTC-3E3297	83.37
LOADER TILT							
	1071855		P-UB-10	2	3-1/2	CTC-7X2783	87.11
	6E0113		P-UB-10	2	3-1/2	CTC-7X2783	87.11
SIDESHIFT							
	1166858		P-UB-10	2	4	CTC-1113302	100.62
SIDESHIFT RH							
	1166858		P-UB-10	2	4	CTC-1113302	100.62
STABILIZER							
	1266950		P-UB-10	1-3/4	2-3/4	CTC-1539053	127.54
	6E3483		P-UB-10	1-3/4	2-3/4	CTC-1539053	127.54
UNSPECIFIED APPLICATION							
	1070624		P-UB-10	1-7/8	3-1/4	CTC-3E3297	83.37
MODEL 438C							
BACKHOE BOOM							
	6E0274		P-UB-10	2-3/8	4-1/2	CTC-3E8877	150.30
BACKHOE BUCKET							
	1268312		I-UB-10	2-3/4	3-3/4	CTC-1361990	147.09
	6E3693		I-UB-10	2-3/4	3-3/4	CTC-1361990	147.09
BACKHOE EXT BUCKET							
	6E1964		I-UB-10	2-1/2	3-1/2	CTC-3E3299	113.42
	6E2421		I-UB-10	2-3/4	3-3/4	CTC-9X2020	92.07
BACKHOE STICK							
	1097021		P-UB-10	2-1/2	4-1/2	CTC-1113300	115.52
	6E0404		P-UB-10	1-1/2	3	CTC-7X2737	91.86
BACKHOE SWING							
	1166861		P-UB-10	2	4	CTC-1113302	100.62
LOADER BUCKET MP							
	9T4006		P-UB-10	1-1/2	3	CTC-7X2737	91.86
LOADER TILT							
	1071855		P-UB-10	2	3-1/2	CTC-7X2783	87.11
SIDESHIFT							
	1166858		P-UB-10	2	4	CTC-1113302	100.62
SIDESHIFT RH							
	1166858		P-UB-10	2	4	CTC-1113302	100.62
STABILIZER							
	1266950		P-UB-10	1-3/4	2-3/4	CTC-1539053	127.54
UNSPECIFIED APPLICATION							
	1070624		P-UB-10	1-7/8	3-1/4	CTC-3E3297	83.37
	1235087		P-UB-10	2	3-1/2	CTC-7X2783	87.11
	1235091		P-UB-10	2	3	CTC-7X2760	54.39
	9T8823		I-O-3	1	2	CTC-9T0418	70.20
MODEL 446							
BACKHOE BOOM							
	1118211		P-UB-10	2-5/8	5-1/4	CTC-1361908	149.58



REPLACEMENT KITS FOR CATERPILLAR® EQUIPMENT

Backhoe-Loaders							
APPLICATION	CYL #	Misc-Parts, Instructions, etc.	CODE	ROD	BORE	KIT #	List \$
MODEL 446							
BACKHOE BUCKET							
	9T6305		I-UB-10	2-3/4	3-3/4	CTC-9X2020	92.07
BACKHOE EXT BUCKET							
	1144828		I-UB-10	2-3/4	3-3/4	CTC-9X2020	92.07
BACKHOE EXT STICK							
	6E5383		P-UB-10	1-3/4	3	CTC-7X2825	42.17
	9T2107		P-UB-10	1-3/4	3	CTC-7X2825	42.17
BACKHOE STICK							
	1118213		P-UB-10	3	5-1/4	CTC-3E3293	150.34
	6E3062		P-UB-10	3	5-1/4	CTC-3E3293	150.34
	6E3314		P-UB-10	3	5-1/4	CTC-3E3293	150.34
	9T9186		P-UB-10	3	5-1/4	CTC-3E3293	150.34
BACKHOE SWING							
	1121765		P-UB-10	2	4	CTC-1113302	100.62
	6E5219		P-UB-10	2	4	CTC-1113302	100.62
BACKHOE SWING LH							
	9T1701		P-UB-10	2-1/8	4	CTC-9X2400	100.80
BACKHOE SWING RH							
	9T1230		P-UB-10	2-1/8	4	CTC-9X2400	100.80
LOADER LIFT							
	1117712		P-UB-10	2-1/4	3-3/4	CTC-1361897	134.65
	1257895		P-UB-10	2-1/4	3-3/4	CTC-1361897	134.65
	9T2997		P-UB-10	2	3-3/4	CTC-7X7938	88.49
LOADER TILT							
	1007844		P-UB-10	2	4	CTC-1113302	100.62
	1007844		P-UB-10	2	4	CTC-1328816	78.46
	9T2995		P-UB-10	2	4	CTC-1113302	100.62
	9T2995		P-UB-10	2	4	CTC-1328816	78.46
STABILIZER							
	9T2993		P-UB-10	2-1/8	4	CTC-9X2400	100.80
	9T2994		P-UB-10	2-1/8	4	CTC-9X2400	100.80
STABILIZER LH							
	1329701		P-UB-10	2-1/8	4	CTC-1305923	134.10
	9T2994		P-UB-10	2-1/8	4	CTC-1305923	134.10
STABILIZER RH							
	1329700		P-UB-10	2-1/8	4	CTC-1305923	134.10
	9T2993		P-UB-10	2-1/8	4	CTC-1305923	134.10
MODEL 446B							
BACKHOE BOOM							
	1118211		P-UB-10	2-5/8	5-1/4	CTC-1361908	149.58
BACKHOE BUCKET							
	1118217		I-UB-10	2-3/4	3-3/4	CTC-9X2020	92.07
	9T6305		I-UB-10	2-3/4	3-3/4	CTC-9X2020	92.07
BACKHOE EXT BUCKET							
	1144828		I-UB-10	2-3/4	3-3/4	CTC-9X2020	92.07
	9T4760		I-UB-10	2-3/4	3-3/4	CTC-9X2020	92.07

CATERPILLAR®



REPLACEMENT KITS FOR CATERPILLAR® EQUIPMENT

Backhoe-Loaders							
APPLICATION	CYL #	Misc-Parts, Instructions, etc.	CODE	ROD	BORE	KIT #	List \$
MODEL 446B							
BACKHOE EXT STICK							
	6E5383		P-UB-10	1-3/4	3	CTC-7X2825	42.17
BACKHOE STICK							
	1118213		P-UB-10	3	5-1/4	CTC-3E3293	150.34
	1239707		P-UB-10	1-3/4	3	CTC-7X2825	42.17
	6E3062		P-UB-10	3	5-1/4	CTC-3E3293	150.34
	6E3314		P-UB-10	3	5-1/4	CTC-3E3293	150.34
	9T9186		P-UB-10	3	5-1/4	CTC-3E3293	150.34
BACKHOE SWING							
	1121765		P-UB-10	2	4	CTC-1113302	100.62
	6E5219		P-UB-10	2	4	CTC-1113302	100.62
BACKHOE SWING LH							
	9T1701		P-UB-10	2-1/8	4	CTC-9X2400	100.80
BACKHOE SWING RH							
	9T1230		P-UB-10	2-1/8	4	CTC-9X2400	100.80
LOADER LIFT							
	1117712		P-UB-10	2-1/4	3-3/4	CTC-1361897	134.65
	1257895		P-UB-10	2-1/4	3-3/4	CTC-1361897	134.65
	9T2997		P-UB-10	2	3-3/4	CTC-7X7938	88.49
LOADER TILT							
	1007844		P-UB-10	2	4	CTC-1113302	100.62
	1007844		P-UB-10	2	4	CTC-1328816	78.46
	9T2995		P-UB-10	2	4	CTC-1328816	78.46
SIDESHIFT							
	1121765		P-UB-10	2	4	CTC-1113302	100.62
STABILIZER LH							
	1329701		P-UB-10	2-1/8	4	CTC-1305923	134.10
	9T2994		P-UB-10	2-1/8	4	CTC-1305923	134.10
STABILIZER RH							
	1329700		P-UB-10	2-1/8	4	CTC-1305923	134.10
	9T2993		P-UB-10	2-1/8	4	CTC-1305923	134.10
Bulldozers							
APPLICATION	CYL #	Misc-Parts, Instructions, etc.	CODE	ROD	BORE	KIT #	List \$
MODEL 3P							
TILT							
	9J8674		P-UB-10	1-1/2	3-1/2	CTC-7X2752	80.70
MODEL 3S							
TILT							
	8J6893		P-UB-10	2	4	CTC-7X2789	86.29
	9J8674		P-UB-10	1-1/2	3-1/2	CTC-7X2752	80.70
MODEL 4S							
DOZER TILT							
	5J1603		P-V-10	2	4-3/4	CTC-7X2677	99.00
MODEL 5A							
LIFT							
	7J8299		P-UB-10	2-1/2	4	CTC-7X2659	132.61



REPLACEMENT KITS FOR CATERPILLAR® EQUIPMENT

Bulldozers							
APPLICATION	CYL #	Misc-Parts, Instructions, etc.	CODE	ROD	BORE	KIT #	List \$
MODEL 5S							
LIFT	7J8302		P-UB-10	2-1/2	4	CTC-7X2659	132.61
TILT	2J1402		P-UB-10	3	6-1/2	CTC-7X2694	134.38
MODEL 6							
LIFT	7J7974		P-UB-10	1-1/2	4	CTC-7X2738	73.99
RIPPER	2K3663		P-UB-10	2-1/2	7-1/4	CTC-7X2661	153.05
MODEL 6S							
TILT	2J1402		P-UB-10	3	6-1/2	CTC-7X2694	134.38
MODEL 7A							
TILT	5J7929		P-UB-10	2-1/2	6	CTC-7X2692	138.95
MODEL 7S, 7U							
DOZER TILT	3G4533		P-UB-10	3	6-1/2	CTC-1126550	149.91
	3J9694		P-U-10	3-1/2	8-1/4	CTC-7X2720	152.83
	6J9752		P-UB-10	3	6-1/2	CTC-1126550	149.91
	9J8748		P-UB-10	3	6-1/2	CTC-1126550	149.91
MODEL 7SU							
DOZER TILT	3G4533		P-UB-10	3	6-1/2	CTC-1126550	149.91
MODEL 8A							
DOZER LIFT	9J8802		P-UB-10	3-1/2	7-1/2	CTC-7X2722	157.13
MODEL 8B							
PIN PULLER	4J5057		P-V-10	1-1/4	4	CTC-8T1480	69.97
MODEL 8D							
RIPPER PIN PULLER	8J2071		P-UB-10	1-1/2	4	CTC-7X2738	73.99
MODEL 8R							
TILT	7J0192		P-UB-10	3-1/2	8-1/4	CTC-7X2721	246.28
MODEL 8S							
DOZER TILT	2J3894		P-U-10	3-1/2	8-1/4	CTC-7X2720	152.83
	3G5707		P-UB-10	3-1/2	8-1/4	CTC-7X2721	246.28
LIFT LH	5J9378		P-UB-10	2-1/2	5	CTC-7X2675	105.11
LIFT RH	5J9708		P-UB-10	2-1/2	5	CTC-7X2675	105.11

CATERPILLAR®



REPLACEMENT KITS FOR CATERPILLAR® EQUIPMENT

Bulldozers							
APPLICATION	CYL #	Misc-Parts, Instructions, etc.	CODE	ROD	BORE	KIT #	List \$
MODEL 8S							
TILT							
	6J2472		P-UB-10	3-1/2	8-1/4	CTC-7X2728	147.99
	7J0192		P-UB-10	3-1/2	8-1/4	CTC-7X2721	246.28
	8J8682		P-UB-10	3-1/2	8-1/4	CTC-7X2721	246.28
MODEL 8U							
	6J2472		P-UB-10	3-1/2	8-1/4	CTC-7X2728	147.99
DOZER TILT							
	2J3894		P-U-10	3-1/2	8-1/4	CTC-7X2720	152.83
	3G5707		P-UB-10	3-1/2	8-1/4	CTC-7X2721	246.28
TILT							
	7J0192		P-UB-10	3-1/2	8-1/4	CTC-7X2721	246.28
	8J8682		P-UB-10	3-1/2	8-1/4	CTC-7X2721	246.28
MODEL 9B							
PIN PULLER							
	4J5057		P-V-10	1-1/4	4	CTC-8T1480	69.97
MODEL 9R							
TILT							
	6J1570		P-UB-10	3-1/2	8-1/4	CTC-7X2721	246.28
MODEL 9S, 9U							
DOZER TILT							
	2J6705		P-U-10	3-1/2	8-1/4	CTC-7X2720	152.83
	3G8661		P-UB-10	4	9-1/4	CTC-7X2799	302.65
TILT							
	6J1570		P-UB-10	3-1/2	8-1/4	CTC-7X2721	246.28
Excavators							
APPLICATION	CYL #	Misc-Parts, Instructions, etc.	CODE	ROD	BORE	KIT #	List \$
MODEL 215							
BOOM							
	8J8613		P-UB-10	2-3/4	4-1/2	CTC-7X2683	154.55
BUCKET							
	8J8612		P-UB-10	2-3/4	4-1/2	CTC-7X2685	138.92
CLAMSHELL							
	9J5832		P-UB-10	3-1/4	6-1/2	CTC-7X2713	113.05
STICK							
	8J8611		P-UB-10	3-1/2	5-1/2	CTC-7X2726	127.19
TRACK ADJUSTER							
			TRK ADJ			CTC-FIG3400	50.60
			TRK ADJ			CTC-FIG3404	33.91
MODEL 215B							
BOOM							
	3G2996		P-UB-10	3-1/4	5-1/2	CTC-7X2705	218.24
	8J8613		P-UB-10	2-3/4	4-1/2	CTC-7X2683	154.55
BUCKET							
	8J8612		P-UB-10	2-3/4	4-1/2	CTC-7X2685	138.92
CLAMSHELL							
	9J5832		P-UB-10	3-1/4	6-1/2	CTC-7X2713	113.05



REPLACEMENT KITS FOR CATERPILLAR® EQUIPMENT

Excavators							
APPLICATION	CYL #	Misc-Parts, Instructions, etc.	CODE	ROD	BORE	KIT #	List \$
MODEL 215B							
STICK							
	8J8611		P-UB-10	3-1/2	5-1/2	CTC-7X2726	127.19
TRACK ADJUSTER							
			TRK ADJ			CTC-FIG3400	50.60
MODEL 215C							
BOOM							
	8J8613		P-UB-10	2-3/4	4-1/2	CTC-7X2683	154.55
BUCKET							
	8J8612		P-UB-10	2-3/4	4-1/2	CTC-7X2685	138.92
STICK							
	8J8611		P-UB-10	3-1/2	5-1/2	CTC-7X2726	127.19
TRACK ADJUSTER							
			TRK ADJ			CTC-FIG3400	50.60
			TRK ADJ			CTC-FIG3404	33.91
MODEL 215D							
BOOM							
	8J8613		P-UB-10	2-3/4	4-1/2	CTC-7X2683	154.55
STICK							
	9T9280		P-UB-10	3-1/2	5-1/2	CTC-7X2726	127.19
TRACK ADJUSTER							
			TRK ADJ			CTC-FIG3400	50.60
			TRK ADJ			CTC-FIG3404	33.91
MODEL 219							
BOOM							
	8J8613		P-UB-10	2-3/4	4-1/2	CTC-7X2683	154.55
BUCKET							
	8J8612		P-UB-10	2-3/4	4-1/2	CTC-7X2685	138.92
STICK							
	8J8611		P-UB-10	3-1/2	5-1/2	CTC-7X2726	127.19
TRACK ADJUSTER							
			TRK ADJ			CTC-FIG3400	50.60
			TRK ADJ			CTC-FIG3404	33.91
MODEL 219D							
STICK							
	9T9280		P-UB-10	3-1/2	5-1/2	CTC-7X2726	127.19
TRACK ADJUSTER							
			TRK ADJ			CTC-FIG3400	50.60
			TRK ADJ			CTC-FIG3404	33.91
MODEL 225							
BOOM							
	3G2996		P-UB-10	3-1/4	5-1/2	CTC-7X2705	218.24
	3G7384		P-UB-10	3-1/4	5-1/2	CTC-7X2705	218.24
	6E3833		P-UB-10	3-1/4	5-1/2	CTC-7X2705	218.24
	6E3836		P-UB-10	3-1/4	5-1/2	CTC-7X2705	218.24
	8J1698		P-UB-10	3-1/4	5-1/2	CTC-7X2705	218.24
	8J1698		P-UB-10	3-1/4	5-1/2	CTC-7X2823	200.54

CATERPILLAR®



REPLACEMENT KITS FOR CATERPILLAR® EQUIPMENT

Excavators							
APPLICATION	CYL #	Misc-Parts, Instructions, etc.	CODE	ROD	BORE	KIT #	List \$
MODEL 225							
BUCKET							
	6E6007		P-UB-10	3-1/4	5-1/2	CTC-7X2705	218.24
	8J2566		P-UB-10	3-1/4	5-1/2	CTC-7X2705	218.24
	8J8612		P-UB-10	2-3/4	4-1/2	CTC-7X2685	138.92
	9J7006		P-UB-10	3-1/4	5-1/2	CTC-1002931	335.33
CLAMSHELL							
	9J5153		P-UB-10	3-1/2	8-1/4	CTC-7X2727	291.27
CONVEYOR SWING							
	9J5153		P-UB-10	3-1/2	8-1/4	CTC-7X2727	291.27
STICK							
	8J1719		P-UB-10	3-3/4	6	CTC-7X2794	326.95
	9J1755		P-UB-10	3-3/4	6	CTC-1002939	414.40
	9T9744		P-UB-10	3-3/4	6	CTC-3E8888	267.80
MODEL 225B							
BOOM							
	3G2996		P-UB-10	3-1/4	5-1/2	CTC-7X2705	218.24
	6E3833		P-UB-10	3-1/4	5-1/2	CTC-7X2705	218.24
	8J1698		P-UB-10	3-1/4	5-1/2	CTC-7X2705	218.24
	8J1698		P-UB-10	3-1/4	5-1/2	CTC-7X2823	200.54
	9T5230		P-UB-10	3-1/2	6	CTC-3E8889	148.46
	9T5230		P-UB-10	3-1/2	6	CTC-7X7735	186.31
BUCKET							
	6E6007		P-UB-10	3-1/4	5-1/2	CTC-7X2705	218.24
	8J8612		P-UB-10	2-3/4	4-1/2	CTC-7X2685	138.92
	9J7006		P-UB-10	3-1/4	5-1/2	CTC-1002931	335.33
	9J7006		P-UB-10	3-1/4	5-1/2	CTC-1002932	335.74
	9J7006		P-UB-10	3-1/4	5-1/2	CTC-7X2709	136.64
STICK							
	9J1755		P-UB-10	3-3/4	6	CTC-1002939	414.40
	9J1755		P-UB-10	3-3/4	6	CTC-7X2794	326.95
	9T9744		P-UB-10	3-3/4	6	CTC-3E8888	267.80
TRACK ADJUSTER							
			TRK ADJ			CTC-FIG3400	50.60
MODEL 225D							
BOOM							
	3G2996		P-UB-10	3-1/4	5-1/2	CTC-7X2705	218.24
	9T5230		P-UB-10	3-1/2	6	CTC-7X7735	186.31
	9T9747		P-UB-10	3-1/2	6	CTC-3E8889	148.46
BUCKET							
	6E6007		P-UB-10	3-1/4	5-1/2	CTC-7X2705	218.24
	8J8612		P-UB-10	2-3/4	4-1/2	CTC-7X2685	138.92
	9J7006		P-UB-10	3-1/4	5-1/2	CTC-1002931	335.33
	9J7006		P-UB-10	3-1/4	5-1/2	CTC-1002932	335.74
	9J7006		P-UB-10	3-1/4	5-1/2	CTC-7X2709	136.64



REPLACEMENT KITS FOR CATERPILLAR® EQUIPMENT

Excavators							
APPLICATION	CYL #	Misc-Parts, Instructions, etc.	CODE	ROD	BORE	KIT #	List \$
MODEL 225D							
STICK							
	6E6009		P-UB-10	3-3/4	6	CTC-1002939	414.40
	9J1755		P-UB-10	3-3/4	6	CTC-1002939	414.40
	9J1755		P-UB-10	3-3/4	6	CTC-7X2794	326.95
	9T9744		P-UB-10	3-3/4	6	CTC-1002939	414.40
	9T9744		P-UB-10	3-3/4	6	CTC-3E8888	267.80
TRACK ADJUSTER							
			TRK ADJ			CTC-FIG3400	50.60
MODEL 227							
ARM							
	1U4732		P-UB-10	3-3/4	6	CTC-7X2814	167.97
BOOM							
	3G2996		P-UB-10	3-1/4	5-1/2	CTC-7X2705	218.24
	3G7264		P-UB-10	3-1/4	5-1/2	CTC-7X2705	218.24
	6E3833		P-UB-10	3-1/4	5-1/2	CTC-7X2705	218.24
	8J1698		P-UB-10	3-1/4	5-1/2	CTC-7X2705	218.24
	8J1698		P-UB-10	3-1/4	5-1/2	CTC-7X2823	200.54
BUCKET							
	6E6007		P-UB-10	3-1/4	5-1/2	CTC-7X2705	218.24
	9J7006		P-UB-10	3-1/4	5-1/2	CTC-1002931	335.33
	9J7006		P-UB-10	3-1/4	5-1/2	CTC-1002932	335.74
	9J7006		P-UB-10	3-1/4	5-1/2	CTC-7X2709	136.64
GRAPPLE							
	3G5672		P-UB-10	1-3/4	3	CTC-7X2791	74.94
SHEAR							
	3G2656		P-UB-10	3-1/4	6-1/2	CTC-7X2713	113.05
STICK							
	1U4731		P-UB-10	3-3/4	6	CTC-1002939	414.40
	9J1755		P-UB-10	3-3/4	6	CTC-1002939	414.40
	9J1755		P-UB-10	3-3/4	6	CTC-7X2794	326.95
	9T9744		P-UB-10	3-3/4	6	CTC-3E8888	267.80
TILT							
	3G9241		P-UB-10	2-1/2	4-1/2	CTC-7X2668	143.84
MODEL 229							
ARM							
	1U4732		P-UB-10	3-3/4	6	CTC-7X2814	167.97
BOOM							
	3G2996		P-UB-10	3-1/4	5-1/2	CTC-7X2705	218.24
	3G7264		P-UB-10	3-1/4	5-1/2	CTC-7X2705	218.24
	6E3833		P-UB-10	3-1/4	5-1/2	CTC-7X2705	218.24
	8J1698		P-UB-10	3-1/4	5-1/2	CTC-7X2705	218.24
	8J1698		P-UB-10	3-1/4	5-1/2	CTC-7X2823	200.54
	9T5230		P-UB-10	3-1/2	6	CTC-3E8889	148.46
	9T5230		P-UB-10	3-1/2	6	CTC-7X7735	186.31

CATERPILLAR®



REPLACEMENT KITS FOR CATERPILLAR® EQUIPMENT

Excavators							
APPLICATION	CYL #	Misc-Parts, Instructions, etc.	CODE	ROD	BORE	KIT #	List \$
MODEL 229							
BUCKET							
	6E6007		P-UB-10	3-1/4	5-1/2	CTC-7X2705	218.24
	9J7006		P-UB-10	3-1/4	5-1/2	CTC-1002931	335.33
	9J7006		P-UB-10	3-1/4	5-1/2	CTC-1002932	335.74
	9J7006		P-UB-10	3-1/4	5-1/2	CTC-7X2709	136.64
STICK							
	9J1755		P-UB-10	3-3/4	6	CTC-1002939	414.40
	9J1755		P-UB-10	3-3/4	6	CTC-7X2794	326.95
	9T9744		P-UB-10	3-3/4	6	CTC-3E8888	267.80
TRACK ADJUSTER							
			TRK ADJ			CTC-FIG3400	50.60
MODEL 229D							
BOOM							
	9T9371		P-UB-10	4	6	CTC-9X6261	240.22
	9T9371		P-UB-10	4	6	CTC-9X6263	197.92
BUCKET							
	6E6007		P-UB-10	3-1/4	5-1/2	CTC-7X2705	218.24
	9J7006		P-UB-10	3-1/4	5-1/2	CTC-1002931	335.33
	9J7006		P-UB-10	3-1/4	5-1/2	CTC-1002932	335.74
	9J7006		P-UB-10	3-1/4	5-1/2	CTC-7X2709	136.64
STICK							
	6E6009		P-UB-10	3-3/4	6	CTC-1002939	414.40
	9T9744		P-UB-10	3-3/4	6	CTC-1002939	414.40
	9T9744		P-UB-10	3-3/4	6	CTC-3E8888	267.80
MODEL 231D							
BOOM							
	1052921		P-UB-10	4	6	CTC-9X6261	240.22
	6E3473		P-UB-10	4-1/4	6-1/2	CTC-8T1461	192.50
	8J4589		P-UB-10	4-1/4	6-1/2	CTC-1002934	339.95
	8J4589		P-UB-10	4-1/4	6-1/2	CTC-1002935	346.05
	8J4589		P-UB-10	4-1/4	6-1/2	CTC-8T1461	192.50
	9T9371		P-UB-10	4	6	CTC-9X6261	240.22
	9T9371		P-UB-10	4	6	CTC-9X6263	197.92
BUCKET							
	6E5021		P-UB-10	4	6	CTC-9X6261	240.22
	9T9514		P-UB-10	4	6	CTC-9X6261	240.22



REPLACEMENT KITS FOR CATERPILLAR® EQUIPMENT

Excavators							
APPLICATION	CYL #	Misc-Parts, Instructions, etc.	CODE	ROD	BORE	KIT #	List \$
MODEL 235							
BOOM							
	1024210		P-UB-10	4-1/4	6-1/2	CTC-8T1461	192.50
	3G3524		P-UB-10	4-3/4	7-1/4	CTC-8T1545	244.45
	4T1689		P-UB-10	4-1/4	6-1/2	CTC-8T1461	192.50
	4T1921		P-UB-10	4-1/4	6-1/2	CTC-8T1461	192.50
	6C5856		P-UB-10	4-1/4	6-1/2	CTC-8T1461	192.50
	6C5857		P-UB-10	4-1/4	6-1/2	CTC-8T1461	192.50
	8J4589		P-UB-10	4-1/4	6-1/2	CTC-1002934	339.95
	8J4589		P-UB-10	4-1/4	6-1/2	CTC-1002935	346.05
	8J4589		P-UB-10	4-1/4	6-1/2	CTC-8T1461	192.50
	9J2153		P-UB-10	4-1/4	6-1/2	CTC-8T1461	192.50
	9T9995		P-UB-10	4-1/4	6-1/2	CTC-8T1461	192.50
	9T9995		P-UB-10	4-1/4	6-1/2	CTC-9X6379	268.52
BOTTOM DUMP							
	1024216		P-UB-14	4-3/4	6-1/2	CTC-8T1462	205.96
	4T0483		P-UB-10	3	7-1/4	CTC-7X2699	182.12
BUCKET							
	1024216		P-UB-14	4-3/4	6-1/2	CTC-8T1462	205.96
	4T2536		P-UB-14	4-3/4	6-1/2	CTC-8T1462	205.96
	8J8918		P-UB-10	4-3/4	6-1/2	CTC-7X7719	224.73
	9J4100		P-UB-14	4-3/4	6-1/2	CTC-8T1462	205.96
	9J8153		P-UB-10	4-3/4	6	CTC-8T1908	184.25
PIN PULLER							
	1U2813		P-UB-10	2-1/2	4	CTC-7X2665	141.19
SLAVE							
	9J4882		P-UB-10	4	5	CTC-7X2816	213.89
STICK							
	3G5646		P-UB-10	5	7-3/4	CTC-8T1479	305.24
	6E5096		P-UB-10	5	7-3/4	CTC-3E8887	379.89
	8J5603		P-UB-10	5	7-3/4	CTC-8T1479	305.24
	9J1755		P-UB-10	3-3/4	6	CTC-1002939	414.40
	9J7850		P-UB-10	5	7-3/4	CTC-8T1479	305.24
	9T1387		P-UB-10	5	7-3/4	CTC-8T1479	305.24
	9T9354		P-UB-10	5	7-3/4	CTC-3E8887	379.89
	9T9744		P-UB-10	3-3/4	6	CTC-3E8888	267.80
MODEL 235 FS							
BOOM							
	4T1921		P-UB-10	4-1/4	6-1/2	CTC-8T1461	192.50
	8J4589		P-UB-10	4-1/4	6-1/2	CTC-1002934	339.95
	8J4589		P-UB-10	4-1/4	6-1/2	CTC-1002935	346.05
	8J4589		P-UB-10	4-1/4	6-1/2	CTC-8T1461	192.50
	9J2153		P-UB-10	4-1/4	6-1/2	CTC-8T1461	192.50
BOTTOM DUMP							
	4T0483		P-UB-10	3	7-1/4	CTC-7X2699	182.12
	9J4697		P-UB-10	3	7-1/4	CTC-7X2699	182.12

CATERPILLAR®



REPLACEMENT KITS FOR CATERPILLAR® EQUIPMENT

Excavators							
APPLICATION	CYL #	Misc-Parts, Instructions, etc.	CODE	ROD	BORE	KIT #	List \$
MODEL 235 FS							
BUCKET							
	4T2536		P-UB-14	4-3/4	6-1/2	CTC-8T1462	205.96
	9J4100		P-UB-10	4-3/4	6-1/2	CTC-7X7718	212.51
	9J4100		P-UB-10	4-3/4	6-1/2	CTC-7X7719	224.73
	9J4100		P-UB-14	4-3/4	6-1/2	CTC-8T1462	205.96
	9J8153		P-UB-10	4-3/4	6	CTC-8T1908	184.25
SLAVE							
	9J4882		P-UB-10	4	5	CTC-7X2816	213.89
STICK							
	3G5646		P-UB-10	5	7-3/4	CTC-8T1479	305.24
MODEL 235B							
BOOM							
	1024210		P-UB-10	4-1/4	6-1/2	CTC-8T1461	192.50
	4T1689		P-UB-10	4-1/4	6-1/2	CTC-8T1461	192.50
	4T1921		P-UB-10	4-1/4	6-1/2	CTC-8T1461	192.50
	6C5856		P-UB-10	4-1/4	6-1/2	CTC-8T1461	192.50
	6C5857		P-UB-10	4-1/4	6-1/2	CTC-8T1461	192.50
	9T9995		P-UB-10	4-1/4	6-1/2	CTC-8T1461	192.50
	9T9995		P-UB-10	4-1/4	6-1/2	CTC-9X6379	268.52
BOTTOM DUMP							
	4T0483		P-UB-10	3	7-1/4	CTC-7X2699	182.12
BUCKET							
	1024217		P-UB-14	4-3/4	6-1/2	CTC-8T1462	205.96
	4T2536		P-UB-14	4-3/4	6-1/2	CTC-8T1462	205.96
	9J8153		P-UB-10	4-3/4	6	CTC-8T1908	184.25
SLAVE							
	9J4882		P-UB-10	4	5	CTC-7X2816	213.89
STICK							
	3G5646		P-UB-10	5	7-3/4	CTC-8T1479	305.24
	6E5096		P-UB-10	5	7-3/4	CTC-3E8887	379.89
	9T1387		P-UB-10	5	7-3/4	CTC-8T1479	305.24
	9T9354		P-UB-10	5	7-3/4	CTC-3E8887	379.89
MODEL 235C							
BOOM							
	1024211		P-UB-10	4-1/4	6-1/2	CTC-8T1461	192.50
	4T1689		P-UB-10	4-1/4	6-1/2	CTC-8T1461	192.50
	4T1921		P-UB-10	4-1/4	6-1/2	CTC-8T1461	192.50
	6C5856		P-UB-10	4-1/4	6-1/2	CTC-8T1461	192.50
	6C5857		P-UB-10	4-1/4	6-1/2	CTC-8T1461	192.50
	6E1643		P-UB-14	4-3/4	7	CTC-8T1567	201.67
	9T6615		P-UB-10	4-3/4	7	CTC-7X7734	366.69
	9T6615		P-UB-14	4-3/4	7	CTC-8T1567	201.67
	9T9360		P-UB-14	4-3/4	7	CTC-8T1567	201.67
	9T9995		P-UB-10	4-1/4	6-1/2	CTC-8T1461	192.50
	9T9995		P-UB-10	4-1/4	6-1/2	CTC-9X6379	268.52
BOTTOM DUMP							
	4T0483		P-UB-10	3	7-1/4	CTC-7X2699	182.12



REPLACEMENT KITS FOR CATERPILLAR® EQUIPMENT

Excavators							
APPLICATION	CYL #	Misc-Parts, Instructions, etc.	CODE	ROD	BORE	KIT #	List \$
MODEL 235C							
BUCKET							
	1024216		P-UB-14	4-3/4	6-1/2	CTC-8T1462	205.96
	4T2536		P-UB-14	4-3/4	6-1/2	CTC-8T1462	205.96
	9J8153		P-UB-10	4-3/4	6	CTC-8T1908	184.25
SLAVE							
	9J4882		P-UB-10	4	5	CTC-7X2816	213.89
STICK							
	3G5646		P-UB-10	5	7-3/4	CTC-8T1479	305.24
	6E5096		P-UB-10	5	7-3/4	CTC-3E8887	379.89
	9T1387		P-UB-10	5	7-3/4	CTC-8T1479	305.24
	9T9354		P-UB-10	5	7-3/4	CTC-3E8887	379.89
MODEL 235C FS							
BOOM							
	4T1689		P-UB-10	4-1/4	6-1/2	CTC-8T1461	192.50
	9T6615		P-UB-10	4-3/4	7	CTC-7X7734	366.69
BOTTOM DUMP							
	4T0483		P-UB-10	3	7-1/4	CTC-7X2699	182.12
BUCKET							
	4T2536		P-UB-14	4-3/4	6-1/2	CTC-8T1462	205.96
	9J8153		P-UB-10	4-3/4	6	CTC-8T1908	184.25
MASTER							
	9J4882		P-UB-10	4	5	CTC-7X2816	213.89
STICK							
	9T1387		P-UB-10	5	7-3/4	CTC-8T1479	305.24
MODEL 235D							
BOOM							
	1024210		P-UB-10	4-1/4	6-1/2	CTC-8T1461	192.50
	4T1689		P-UB-10	4-1/4	6-1/2	CTC-8T1461	192.50
	6C5856		P-UB-10	4-1/4	6-1/2	CTC-8T1461	192.50
	6C5857		P-UB-10	4-1/4	6-1/2	CTC-8T1461	192.50
	6E1643		P-UB-14	4-3/4	7	CTC-8T1567	201.67
	9T9995		P-UB-10	4-1/4	6-1/2	CTC-8T1461	192.50
	9T9995		P-UB-10	4-1/4	6-1/2	CTC-9X6379	268.52
BOTTOM DUMP							
	4T0483		P-UB-10	3	7-1/4	CTC-7X2699	182.12
BUCKET							
	1024216		P-UB-14	4-3/4	6-1/2	CTC-8T1462	205.96
	4T2536		P-UB-14	4-3/4	6-1/2	CTC-8T1462	205.96
SLAVE							
	9J4882		P-UB-10	4	5	CTC-7X2816	213.89
STICK							
	6E5096		P-UB-10	5	7-3/4	CTC-3E8887	379.89
	9T9354		P-UB-10	5	7-3/4	CTC-3E8887	379.89
TRACK ADJUSTER							
			TRK ADJ			CTC-FIG0405	83.86

CATERPILLAR®



REPLACEMENT KITS FOR CATERPILLAR® EQUIPMENT

Excavators							
APPLICATION	CYL #	Misc-Parts, Instructions, etc.	CODE	ROD	BORE	KIT #	List \$
MODEL 245 FS							
BOOM							
	3G4615		P-UB-10	5	6	CTC-8T1909	285.70
	9J5379		P-UB-14	4-3/4	7	CTC-8T1567	201.67
BUCKET							
	1U1646		P-UB-14	4-3/4	7	CTC-8T1565	207.62
	8J8721		P-UB-14	4-3/4	7	CTC-8T1565	207.62
STICK							
	3G2778		P-UB-10	5-3/4	8-1/4	CTC-8T1558	522.85
MODEL 245, 245B							
BOOM							
	1024212		P-UB-14	4-3/4	7	CTC-8T1567	201.67
	3G3524		P-UB-10	4-3/4	7-1/4	CTC-8T1545	244.45
	3G4615		P-UB-10	5	6	CTC-8T1909	285.70
	8J3720		P-UB-14	4-3/4	7	CTC-8T1567	201.67
	9J5379		P-UB-14	4-3/4	7	CTC-8T1567	201.67
	9T9358		P-UB-10	4-3/4	7-1/4	CTC-8T1545	244.45
BOTTOM DUMP							
	1U1659		P-UB-10	3-1/2	7-3/4	CTC-9X2644	196.08
BUCKET							
	1U1646		P-UB-14	4-3/4	7	CTC-8T1565	207.62
	1U1646		P-UB-14	4-3/4	7	CTC-8T1567	201.67
	1U1659		P-UB-10	3-1/2	7-3/4	CTC-9X2644	196.08
	8J8721		P-U-10	4-3/4	7	CTC-1371946	309.67
	8J8721		P-UB-14	4-3/4	7	CTC-8T1565	207.62
	9J7755		P-UB-10	5-3/4	7	CTC-8C4398	301.84
	9J9398		P-UB-10	5-3/4	7	CTC-8C4398	301.84
COUNTERWEIGHT							
	8J6167		P-UB-10	2-1/2	5	CTC-7X2658	147.39
LIFT							
	8J6167		P-UB-10	2-1/2	5	CTC-1315118	150.48
	8J6167		P-UB-10	2-1/2	5	CTC-7X2658	147.39
STICK							
	1011908		P-UB-10	5-3/4	8-1/4	CTC-3E8880	611.83
	3G2778		P-UB-10	5-3/4	8-1/4	CTC-3E8880	611.83
	3G2778		P-UB-10	5-3/4	8-1/4	CTC-8T1558	522.85
	6E5093		P-UB-10	5-3/4	8-1/4	CTC-3E8880	611.83
	9T1388		P-UB-10	5-3/4	8-1/4	CTC-3E8880	611.83
	9T1388		P-UB-10	5-3/4	8-1/4	CTC-8T1558	522.85
	9T9356		P-UB-10	5-3/4	8-1/4	CTC-3E8880	611.83
TRACK ADJUSTER							
			TRK ADJ			CTC-FIG0405	83.86
MODEL 245B FS							
BOOM							
	3G3524		P-UB-10	4-3/4	7-1/4	CTC-8T1545	244.45
	3G4615		P-UB-10	5	6	CTC-8T1909	285.70
	9J5379		P-UB-14	4-3/4	7	CTC-8T1567	201.67



REPLACEMENT KITS FOR CATERPILLAR® EQUIPMENT

Excavators							
APPLICATION	CYL #	Misc-Parts, Instructions, etc.	CODE	ROD	BORE	KIT #	List \$
MODEL 245B FS							
BUCKET							
	1U1646		P-UB-14	4-3/4	7	CTC-8T1565	207.62
	8J8721		P-UB-14	4-3/4	7	CTC-8T1565	207.62
STICK							
	3G2778		P-UB-10	5-3/4	8-1/4	CTC-8T1558	522.85
MODEL 245D							
BOOM							
	1024212		P-UB-14	4-3/4	7	CTC-8T1567	201.67
	3G3524		P-UB-10	4-3/4	7-1/4	CTC-8T1545	244.45
	8J3720		P-UB-14	4-3/4	7	CTC-8T1567	201.67
	9J5379		P-UB-14	4-3/4	7	CTC-8T1567	201.67
	9T9358		P-UB-10	4-3/4	7-1/4	CTC-8T1545	244.45
BOTTOM DUMP							
	1U1659		P-UB-10	3-1/2	7-3/4	CTC-9X2644	196.08
BUCKET							
	1U1646		P-UB-14	4-3/4	7	CTC-8T1565	207.62
	1U1646		P-UB-14	4-3/4	7	CTC-8T1567	201.67
	8J8721		P-U-10	4-3/4	7	CTC-1371946	309.67
	9J9398		P-UB-10	5-3/4	7	CTC-8C4398	301.84
LIFT							
	8J6167		P-UB-10	2-1/2	5	CTC-1315118	150.48
	8J6167		P-UB-10	2-1/2	5	CTC-7X2658	147.39
STICK							
	1011908		P-UB-10	5-3/4	8-1/4	CTC-3E8880	611.83
	3G2778		P-UB-10	5-3/4	8-1/4	CTC-3E8880	611.83
	6E5093		P-UB-10	5-3/4	8-1/4	CTC-3E8880	611.83
	9T1388		P-UB-10	5-3/4	8-1/4	CTC-3E8880	611.83
	9T1388		P-UB-10	5-3/4	8-1/4	CTC-8T1558	522.85
	9T9356		P-UB-10	5-3/4	8-1/4	CTC-3E8880	611.83
TRACK ADJUSTER							
			TRK ADJ			CTC-FIG0405	83.86
MODEL 303 C CR							
BLADE ANGLE							
	BXT1-UP						
			P-U-10	35 mm	65 mm	CTC-2839122	36.22
BLADE RAISE LOWER							
	BXT1-UP						
	2666979		P-U-10	45 mm	80 mm	CTC-2788641	62.15
BOOM							
	BXT1-UP						
	2737033		P-U-10	45 mm	80 mm	CTC-2788641	62.15
	2840420		P-U-10	45 mm	80 mm	CTC-2788641	62.15
	2855034		P-U-10	50 mm	85 mm	CTC-2790639	69.13
STICK							
	BXT1-UP						
	2840863		P-U-10	45 mm	80 mm	CTC-2797940	66.31

CATERPILLAR®



REPLACEMENT KITS FOR CATERPILLAR® EQUIPMENT

Excavators							
APPLICATION	CYL #	Misc-Parts, Instructions, etc.	CODE	ROD	BORE	KIT #	List \$
MODEL 303 C CR							
TILTABLE BUCKET							
BXT1-UP							
	2460192		P-UB-10	1-1/2	3	CTC-2460192K	30.88
	2460192		Bushing	1-1/2	1-5/8	CTC-4T6780	7.61
MODEL 304 C CR							
BLADE ANGLE							
FPK1-UP							
	2704714		P-U-10	35 mm	65 mm	CTC-2839122	36.22
BLADE RAISE LOWER							
FPK1-UP							
	2937158		P-U-10	55 mm	90 mm	CTC-2937158K	65.09
BOOM							
FPK1-UP							
	2666975		P-U-10	55 mm	90 mm	CTC-2666975K	65.09
	2709475		P-UB-14	55 mm	95 mm	CTC-2773395	81.99
	2828548		P-UB-14	55 mm	95 mm	CTC-2773395	81.99
BUCKET							
FPK1-UP							
	2666969		P-UB-14	45 mm	75 mm	CTC-2774167	107.88
STICK							
FPK1-UP							
	2828550		P-UB-14	50 mm	85 mm	CTC-2774140	69.15
TILTABLE BUCKET							
FPK1-UP							
	2460192		P-UB-10	1-1/2	3	CTC-2460192K	30.88
MODEL 305 C CR							
BLADE							
HWJ1-834							
	2666977		P-U-10	55 mm	90 mm	CTC-2666977K	65.09
HWJ1-UP							
	2937158		P-U-10	55 mm	90 mm	CTC-2937158K	65.09
BLADE ANGLE							
HWJ1-UP							
	2704714		P-U-10	35 mm	65 mm	CTC-2839122	36.22
BOOM							
HWJ1-UP							
	2666975		P-U-10	55 mm	90 mm	CTC-2666975K	65.09
	2737025		P-U-10	55 mm	100 mm	CTC-2737025K	92.96
	2821535		P-U-10	55 mm	100 mm	CTC-2821535K	92.98
BUCKET							
HWJ1-UP							
	2666967		P-U-10	50 mm	80 mm	CTC-2666967K	84.36
STICK							
HWJ1-UP							
	2821537		P-U-10	55 mm	90 mm	CTC-2821537K	64.23
TILTABLE BUCKET							
HWJ1-UP							
	2460192		P-UB-10	1-1/2	3	CTC-2460192K	30.88



REPLACEMENT KITS FOR CATERPILLAR® EQUIPMENT

Excavators							
APPLICATION	CYL #	Misc-Parts, Instructions, etc.	CODE	ROD	BORE	KIT #	List \$
MODEL 307							
BLADE LH							
	1076377		P-UB-15	50 mm	90 mm	CTC-933045	244.49
	1148378		P-UB-15	50 mm	90 mm	CTC-933045	244.49
BLADE RH							
	1076472		P-UB-15	50 mm	90 mm	CTC-933045	244.49
	1148377		P-UB-15	50 mm	90 mm	CTC-933045	244.49
BOOM							
	1038195		P-UB-14	75 mm	110 mm	CTC-1057255	230.17
	1057468		P-UB-14	55 mm	100 mm	CTC-1057480	178.70
	1239937		P-UB-14	55 mm	100 mm	CTC-1057480	178.70
BUCKET							
	1057238		P-UB-14	55 mm	80 mm	CTC-1057253	156.25
OFFSET							
	1057468		P-UB-14	55 mm	100 mm	CTC-1057480	178.70
	1239937		P-UB-14	55 mm	100 mm	CTC-1057480	178.70
STICK							
	1038320		P-UB-14	60 mm	90 mm	CTC-1038333	209.64
	1057437		P-UB-14	60 mm	90 mm	CTC-1038333	209.64
	1251494		P-UB-14	60 mm	90 mm	CTC-1038333	209.64
MODEL 307B							
BLADE							
	1231627		P-UB-10	80 mm	120 mm	CTC-1697835	182.89
	1624835		P-UB-10	80 mm	120 mm	CTC-1697835	182.89
BUCKET							
	1057238		P-UB-14	55 mm	80 mm	CTC-1057253	156.25
OFFSET							
	1239937		P-UB-14	55 mm	100 mm	CTC-1057480	178.70
STICK							
	1038320		P-UB-14	60 mm	90 mm	CTC-1038333	209.64
MODEL 308B							
BLADE							
	1231627		P-UB-10	80 mm	120 mm	CTC-1697835	182.89
	1624835		P-UB-10	80 mm	120 mm	CTC-1697835	182.89
BUCKET							
	1057238		P-UB-14	55 mm	80 mm	CTC-1057253	156.25
STICK							
	1038320		P-UB-14	60 mm	90 mm	CTC-1038333	209.64
MODEL 311							
BUCKET							
	1251547		P-UB-10	65 mm	100 mm	CTC-418914	172.89
	1346987		P-UB-10	65 mm	100 mm	CTC-1764935	187.18
	418840		P-UB-10	65 mm	100 mm	CTC-418914	172.89
STICK							
	1251549		P-UB-10	75 mm	110 mm	CTC-418913	246.15
	418842		P-UB-10	75 mm	110 mm	CTC-418913	246.15

CATERPILLAR®



REPLACEMENT KITS FOR CATERPILLAR® EQUIPMENT

Excavators							
APPLICATION	CYL #	Misc-Parts, Instructions, etc.	CODE	ROD	BORE	KIT #	List \$
MODEL 311B							
BLADE LH							
	1298009		P-UB-10	80 mm	120 mm	CTC-1697835	182.89
BLADE RH							
	1298010		P-UB-10	80 mm	120 mm	CTC-1697835	182.89
BUCKET							
	1195447		P-UB-10	65 mm	100 mm	CTC-1195457	181.46
	1438158		P-UB-10	65 mm	100 mm	CTC-1697839	185.28
STICK							
	1211406		P-UB-10	75 mm	110 mm	CTC-1195435	249.91
	1438160		P-UB-10	75 mm	110 mm	CTC-1697837	219.71
MODEL 312							
BOOM							
	1148519		P-UB-10	75 mm	110 mm	CTC-1148526	202.84
	1251545		P-UB-10	75 mm	110 mm	CTC-418913	246.15
	418838		P-UB-10	75 mm	110 mm	CTC-418913	246.15
BUCKET							
	1195447		P-UB-10	65 mm	100 mm	CTC-1195457	181.46
	1251547		P-UB-10	65 mm	100 mm	CTC-418914	172.89
	1346987		P-UB-10	65 mm	100 mm	CTC-1764935	187.18
	418840		P-UB-10	65 mm	100 mm	CTC-418914	172.89
OFFSET							
	1239906		P-UB-10	70 mm	130 mm	CTC-1697843	248.60
STICK							
	1211406		P-UB-10	75 mm	110 mm	CTC-1195435	249.91
	1239943		P-UB-10	80 mm	120 mm	CTC-1148290	171.65
	1251546		P-UB-10	80 mm	120 mm	CTC-513047	207.12
	1251940		P-UB-10	80 mm	120 mm	CTC-1148290	171.65
	418839		P-UB-10	80 mm	120 mm	CTC-513047	207.12
MODEL 312B, 312BL							
BLADE LH							
	1298009		P-UB-10	80 mm	120 mm	CTC-1697835	182.89
BLADE RH							
	1298010		P-UB-10	80 mm	120 mm	CTC-1697835	182.89
BOOM							
	1195425		P-UB-10	75 mm	110 mm	CTC-1195435	249.91
	1438156		P-UB-10	75 mm	110 mm	CTC-1697837	219.71
BUCKET							
	1195447		P-UB-10	65 mm	100 mm	CTC-1195457	181.46
	1438158		P-UB-10	65 mm	100 mm	CTC-1697839	185.28
STICK							
	1195436		P-UB-10	80 mm	120 mm	CTC-1195446	227.99
	1438157		P-UB-10	80 mm	120 mm	CTC-1697838	229.50
MODEL 312C, 312CL							
BOOM							
			Bushing	75 mm		CTC-1140750	24.84
			P-UB-10	75 mm	110 mm	CTC-1709937	131.78



REPLACEMENT KITS FOR CATERPILLAR® EQUIPMENT

Excavators							
APPLICATION	CYL #	Misc-Parts, Instructions, etc.	CODE	ROD	BORE	KIT #	List \$
MODEL 312C, 312CL							
BUCKET							
			Bushing	65 mm		CTC-1140754	20.58
			P-UB-10	65 mm	100 mm	CTC-1709941	109.74
STICK							
			Bushing	80 mm		CTC-1140755	27.24
			P-UB-10	80 mm	120 mm	CTC-1709999	162.88
MODEL 313B							
BLADE LH							
	1298009		P-UB-10	80 mm	120 mm	CTC-1697835	182.89
BLADE RH							
	1298010		P-UB-10	80 mm	120 mm	CTC-1697835	182.89
BOOM							
	1624758		P-UB-10	75 mm	110 mm	CTC-1697837	219.71
BUCKET							
	1346987		P-UB-10	65 mm	100 mm	CTC-1764935	187.18
	1438158		P-UB-10	65 mm	100 mm	CTC-1697839	185.28
OFFSET							
	1239906		P-UB-10	70 mm	130 mm	CTC-1697843	248.60
STICK							
	1195436		P-UB-10	80 mm	120 mm	CTC-1195446	227.99
	1211406		P-UB-10	75 mm	110 mm	CTC-1195435	249.91
	1438157		P-UB-10	80 mm	120 mm	CTC-1697838	229.50
	1438160		P-UB-10	75 mm	110 mm	CTC-1697837	219.71
MODEL 315							
BOOM							
	1057336		P-UB-10	80 mm	110 mm	CTC-1057359	207.37
	1276046		P-UB-10	80 mm	110 mm	CTC-1057359	207.37
BUCKET							
	1057381		P-UB-10	70 mm	100 mm	CTC-1057397	171.51
	1076640		P-UB-10	80 mm	110 mm	CTC-1057359	207.37
	1276056		P-UB-10	70 mm	100 mm	CTC-1057397	171.51
	1276060		P-UB-10	80 mm	110 mm	CTC-1057359	207.37
STICK							
	1057362		P-UB-10	85 mm	120 mm	CTC-1057379	219.24
	1276051		P-UB-10	85 mm	120 mm	CTC-1057379	219.24
MODEL 315B							
BOOM							
	1SW1-UP; 3AW1-UP; 7RZ1-UP						
	1559251		Bushing	80 mm		CTC-1140755	27.24
	1559251		P-UB-10	80 mm	110 mm	CTC-1659420	117.63
BUCKET							
	1SW1-UP; 3AW1-UP; 7RZ1-UP						
	1733490		Bushing	70 mm		CTC-1140753	23.67
	1733490		P-UB-10	70 mm	100 mm	CTC-1799638	82.66

CATERPILLAR®



REPLACEMENT KITS FOR CATERPILLAR® EQUIPMENT

Excavators							
APPLICATION	CYL #	Misc-Parts, Instructions, etc.	CODE	ROD	BORE	KIT #	List \$
MODEL 315B							
STICK							
1SW1-UP; 3AW1-UP; 7RZ1-UP							
1559253			Bushing	85 mm		CTC-1140756	29.72
1559253			P-UB-10	85 mm	120 mm	CTC-1659418	109.81
MODEL 315B L							
BOOM							
1SW1-UP; 3AW1-UP; 5SW1-UP; 7RZ1-UP							
1559251			Bushing	80 mm		CTC-1140755	27.24
1559251			P-UB-10	80 mm	110 mm	CTC-1659420	117.63
5SW1-UP							
1336630			Bushing	80 mm		CTC-1140755	27.24
1336630			P-UB-10	80 mm	110 mm	CTC-1336646	209.60
1847660			Bushing	85 mm		CTC-1140756	29.72
1847660			P-UB-10	85 mm	140 mm	CTC-1847660K	114.60
BUCKET							
1SW1-UP; 3AW1-UP; 7RZ1-UP							
1733490			Bushing	70 mm		CTC-1140753	23.67
1733490			P-UB-10	70 mm	100 mm	CTC-1799638	82.66
5SW1-UP							
1336636			Bushing	70 mm		CTC-1140753	23.67
1336636			P-UB-10	70 mm	100 mm	CTC-1336691	181.96
1336639			Bushing	80 mm		CTC-1140755	27.24
1336639			P-UB-10	80 mm	110 mm	CTC-1336646	209.60
1559255			Bushing	70 mm		CTC-1140753	23.67
1559255			P-UB-10	70 mm	100 mm	CTC-1709827	92.77
1588923			Bushing	80 mm		CTC-1140755	27.24
1588923			P-UB-10	80 mm	110 mm	CTC-1659420	117.63
STICK							
1SW1-UP; 3AW1-UP; 5SW1-UP; 7RZ1-UP							
1559253			Bushing	85 mm		CTC-1140756	29.72
1559253			P-UB-10	85 mm	120 mm	CTC-1659418	109.81
5SW1-UP							
1336633			Bushing	85 mm		CTC-1140756	29.72
1336633			P-UB-10	85 mm	120 mm	CTC-1184131	211.36
MODEL 315B, 315B							
BOOM							
1336630			Bushing	80 mm		CTC-1140755	27.24
1336630	Piston - C 1276047		P-UB-10	80 mm	110 mm	CTC-1336646	209.60
BUCKET							
1336636			Bushing	70 mm		CTC-1140753	23.67
1336636	Piston - C 1336687		P-UB-10	70 mm	100 mm	CTC-1336691	181.96
5SW							
1336639			P-UB-10	80 mm	110 mm	CTC-1336646	209.60
STICK							
1336633			Bushing	85 mm		CTC-1140756	29.72
1336633	Piston - C 1276052		P-UB-10	85 mm	120 mm	CTC-1184131	211.36



REPLACEMENT KITS FOR CATERPILLAR® EQUIPMENT

Excavators							
APPLICATION	CYL #	Misc-Parts, Instructions, etc.	CODE	ROD	BORE	KIT #	List \$
MODEL 315C							
BOOM							
AKE1-UP; CFB1-UP; CFT1-UP; CJC1-UP							
1733482			Bushing	80 mm		CTC-1140755	27.24
1733482			P-UB-10	80 mm	110 mm	CTC-1799625	212.96
BUCKET							
AKE1-UP; CFB1-UP; CFT1-UP; CJC1-UP							
1733490			Bushing	70 mm		CTC-1140753	23.67
1733490			P-UB-10	70 mm	100 mm	CTC-1799638	82.66
1733493			Bushing	80 mm		CTC-1140755	27.24
1733493			P-UB-10	80 mm	110 mm	CTC-1799625	212.96
2836126			Bushing	70 mm		CTC-1140753	23.67
2836126			P-UB-10	70 mm	100 mm	CTC-1799638	82.66
2836128			Bushing	80 mm		CTC-1140755	27.24
2836128			P-UB-10	80 mm	110 mm	CTC-1799625	212.96
STICK							
AKE1-UP; CFB1-UP; CFT1-UP; CJC1-UP							
1733486			Bushing	85 mm		CTC-1140756	29.72
1733486			P-UB-10	85 mm	120 mm	CTC-1799634	109.81
MODEL 315C L							
BOOM							
AKE1-UP; ANF1-UP; CFB1-UP; CFT1-UP; CJC1-UP							
1733482			Bushing	80 mm		CTC-1140755	27.24
1733482			P-UB-10	80 mm	110 mm	CTC-1799625	212.96
ANF1-UP							
1559251			Bushing	80 mm		CTC-1140755	27.24
1559251			P-UB-10	80 mm	110 mm	CTC-1659420	117.63
1847660			Bushing	85 mm		CTC-1140756	29.72
1847660			P-UB-10	85 mm	140 mm	CTC-1847660K	114.60
BUCKET							
AKE1-UP; ANF1-UP; CFB1-UP; CFT1-UP; CJC1-UP							
1733490			Bushing	70 mm		CTC-1140753	23.67
1733490			P-UB-10	70 mm	100 mm	CTC-1799638	82.66
1733493			Bushing	80 mm		CTC-1140755	27.24
1733493			P-UB-10	80 mm	110 mm	CTC-1799625	212.96
2836126			Bushing	70 mm		CTC-1140753	23.67
2836126			P-UB-10	70 mm	100 mm	CTC-1799638	82.66
AKE1-UP; CFB1-UP; CFT1-UP; CJC1-UP							
2836128			Bushing	80 mm		CTC-1140755	27.24
2836128			P-UB-10	80 mm	110 mm	CTC-1799625	212.96
ANF1-UP							
2836128			Bushing	80 mm		CTC-1140755	27.24
2836128			P-UB-10	80 mm	110 mm	CTC-1799625	212.96
STICK							
AKE1-UP; CFB1-UP; CFT1-UP; CJC1-UP							
1733486			Bushing	85 mm		CTC-1140756	29.72
1733486			P-UB-10	85 mm	120 mm	CTC-1799634	109.81

CATERPILLAR®



REPLACEMENT KITS FOR CATERPILLAR® EQUIPMENT

Excavators							
APPLICATION	CYL #	Misc-Parts, Instructions, etc.	CODE	ROD	BORE	KIT #	List \$
MODEL 315C L							
STICK							
ANF1-UP							
	1559253		Bushing	85 mm		CTC-1140756	29.72
	1559253		P-UB-10	85 mm	120 mm	CTC-1659418	109.81
	2248528		Bushing	85 mm		CTC-1140756	29.72
	2248528		P-UB-10	85 mm	120 mm	CTC-1659418	109.81
MODEL 315L							
BOOM							
	1057336		P-UB-10	80 mm	110 mm	CTC-1057359	207.37
BUCKET							
	1057381		P-UB-10	70 mm	100 mm	CTC-1057397	171.51
	1076640		P-UB-10	80 mm	110 mm	CTC-1057359	207.37
STICK							
	1057362		P-UB-10	85 mm	120 mm	CTC-1057379	219.24
MODEL 317							
BOOM							
	1057336		P-UB-10	80 mm	110 mm	CTC-1057359	207.37
	1276046		P-UB-10	80 mm	110 mm	CTC-1057359	207.37
BUCKET							
	1057381		P-UB-10	70 mm	100 mm	CTC-1057397	171.51
	1076640		P-UB-10	80 mm	110 mm	CTC-1057359	207.37
	1276056		P-UB-10	70 mm	100 mm	CTC-1057397	171.51
	1276060		P-UB-10	80 mm	110 mm	CTC-1057359	207.37
STICK							
	1057362		P-UB-10	85 mm	120 mm	CTC-1057379	219.24
	1276051		P-UB-10	85 mm	120 mm	CTC-1057379	219.24
MODEL 317B, 317BL							
BOOM							
	1336630		Bushing	80 mm		CTC-1140755	27.24
	1336630	Piston - C 1276047	P-UB-10	80 mm	110 mm	CTC-1336646	209.60
BUCKET							
	1336636		Bushing	70 mm		CTC-1140753	23.67
	1336636	Piston - C 1336687	P-UB-10	70 mm	100 mm	CTC-1336691	181.96
5SW							
	1336639		P-UB-10	80 mm	110 mm	CTC-1336646	209.60
STICK							
	1336633		Bushing	85 mm		CTC-1140756	29.72
	1336633	Piston - C 1276052	P-UB-10	85 mm	120 mm	CTC-1184131	211.36
MODEL 317N							
BOOM							
	1057336		P-UB-10	80 mm	110 mm	CTC-1057359	207.37
BUCKET							
	1057381		P-UB-10	70 mm	100 mm	CTC-1057397	171.51
	1076640		P-UB-10	80 mm	110 mm	CTC-1057359	207.37
STICK							
	1057362		P-UB-10	85 mm	120 mm	CTC-1057379	219.24

CATERPILLAR®



REPLACEMENT KITS FOR CATERPILLAR® EQUIPMENT

Excavators							
APPLICATION	CYL #	Misc-Parts, Instructions, etc.	CODE	ROD	BORE	KIT #	List \$
MODEL 318B, 318BL							
BOOM							
	1475755		P-UB-10	85 mm	120 mm	CTC-1373763	312.80
BUCKET							
	1183967		P-UB-10	85 mm	120 mm	CTC-1261947	292.79
	1184134		P-UB-10	85 mm	120 mm	CTC-1184131	211.36
MODEL 320							
BOOM							
	0874898		P-UB-10	85 mm	120 mm	CTC-1764934	196.72
	0875491		P-UB-10	85 mm	120 mm	CTC-413665	264.78
	0875496		P-UB-10	85 mm	120 mm	CTC-0875394	218.89
	0875496		P-UB-10	85 mm	120 mm	CTC-1184131	211.36
	1069596		P-UB-10	95 mm	160 mm	CTC-6C6091	284.91
BOOM VA							
	6C6085		P-UB-10	95 mm	160 mm	CTC-6C6091	284.91
BUCKET							
	0874899		P-UB-10	85 mm	120 mm	CTC-1186023	225.29
	0875633		P-UB-10	85 mm	120 mm	CTC-0875394	218.89
	0875633		P-UB-10	85 mm	120 mm	CTC-1184131	211.36
	1185931		P-UB-10	85 mm	120 mm	CTC-1186023	225.29
	1251547		P-UB-10	65 mm	100 mm	CTC-418914	172.89
	1346987		P-UB-10	65 mm	100 mm	CTC-1764935	187.18
	417652		P-UB-10	65 mm	100 mm	CTC-417664	172.96
	418840		P-UB-10	65 mm	100 mm	CTC-418914	172.89
	717291		P-UB-10	85 mm	130 mm	CTC-7Y5145	226.08
	7Y5100		P-UB-10	85 mm	130 mm	CTC-7Y5145	226.08
STICK							
	0875422		P-UB-10	100 mm	140 mm	CTC-0875387	289.01
	0875493		P-UB-10	100 mm	140 mm	CTC-1270630	287.74
	0876638		P-UB-10	100 mm	140 mm	CTC-0875387	289.01
	7Y4650		P-UB-10	105 mm	150 mm	CTC-1163612	255.25
MODEL 320B, 320BL							
BOOM							
	1183953		P-UB-10	100 mm	140 mm	CTC-1373764	272.99
	1183955		P-UB-10	100 mm	140 mm	CTC-1373764	272.99
	1184023		P-UB-10	85 mm	120 mm	CTC-1373763	312.80
	1184128		P-UB-10	85 mm	120 mm	CTC-1184131	211.36
	1195425		P-UB-10	75 mm	110 mm	CTC-1195435	249.91
	1232081		P-UB-10	105 mm	150 mm	CTC-1373767	354.28
	1336770		P-UB-10	100 mm	140 mm	CTC-1336823	271.64
	1589058		P-UB-10	85 mm	120 mm	CTC-1589092	154.26
	1842614		P-UB-10	95 mm	160 mm	CTC-1884457	185.51

CATERPILLAR®



REPLACEMENT KITS FOR CATERPILLAR® EQUIPMENT

Excavators							
APPLICATION	CYL #	Misc-Parts, Instructions, etc.	CODE	ROD	BORE	KIT #	List \$
MODEL 320B, 320BL							
BUCKET							
1183967			P-UB-10	85 mm	120 mm	CTC-1261947	292.79
1184134			P-UB-10	85 mm	120 mm	CTC-1184131	211.36
1195447			P-UB-10	65 mm	100 mm	CTC-1195457	181.46
1232044			P-UB-10	90 mm	130 mm	CTC-1184175	249.77
1232084			P-UB-10	90 mm	130 mm	CTC-1373768	372.60
1251547			P-UB-10	65 mm	100 mm	CTC-418914	172.89
1346987			P-UB-10	65 mm	100 mm	CTC-1764935	187.18
1475780			P-UB-10	85 mm	125 mm	CTC-1475781	243.29
1540756			P-UB-10	90 mm	130 mm	CTC-1540757	379.28
1589061			P-UB-10	85 mm	120 mm	CTC-1589092	154.26
1799764			P-UB-10	90 mm	130 mm	CTC-1799772	174.88
417652			P-UB-10	65 mm	100 mm	CTC-417664	172.96
418840			P-UB-10	65 mm	100 mm	CTC-418914	172.89
STICK							
1184000			P-UB-10	105 mm	150 mm	CTC-1680758	295.22
1232081			P-UB-10	105 mm	150 mm	CTC-1373767	354.28
1589059			P-UB-10	100 mm	140 mm	CTC-1589093	103.63
1589060			P-UB-10	100 mm	140 mm	CTC-1589093	103.63
TILT CAB							
N/A			P-UB-10	2-1/4	5	CTC-9X6392	135.36
UNSPECIFIED APPLICATION							
1336771			P-UB-10	105 mm	150 mm	CTC-1373767	354.28
1336812			P-UB-10	90 mm	130 mm	CTC-1373768	372.60
1540727			P-UB-10	85 mm	120 mm	CTC-1540728	412.57
1540743			P-UB-10	85 mm	120 mm	CTC-1540744	396.77
1540772			P-UB-10	90 mm	130 mm	CTC-1540773	379.03
MODEL 320C							
BOOM							
AMC1-UP; ANB1-UP; BBC1-UP; BDC1-UP; BEF1-UP; BER1-UP; BPR1-UP; BRXI-UP							
1588991			Bushing	85 mm		CTC-0964402	27.84
1588991			P-UB-10	85 mm	120 mm	CTC-1373763	312.80
AMC1-UP; ANB1-UP; BDC1-UP; BER1-UP; BPR1-UP; BRXI-UP; GNG1-UP; HKT1-UP; MAB1-UP; PAB1-UP; RAW1-UP; SBN1-UP							
2043614			Bushing	85 mm		CTC-0964402	27.84
2043614			P-UB-10	85 mm	120 mm	CTC-2478998	137.75
AMC1-UP; ANB1-UP; GHA1-UP; GNG1-UP; HBC1-UP; HKT1-UP; MAB1-UP; PAB1-UP							
1850340			Bushing	85 mm		CTC-0964402	27.84
1850340			P-UB-10	85 mm	120 mm	CTC-2478996	137.75
AMC1-UP; ANB1-UP; MAB1-UP; PAB1-UP							
2043616			Bushing	100 mm		CTC-0965625	41.45
2043616			P-UB-10	100 mm	140 mm	CTC-2590633	130.38
2590702			Bushing	100 mm		CTC-0965625	41.45
2590702			P-UB-10	100 mm	140 mm	CTC-2590699	130.38
AXK1-UP							
1842614			P-UB-10	95 mm	160 mm	CTC-2521191	165.19
1842614			Bushing	95 mm		CTC-6C6093	38.29



REPLACEMENT KITS FOR CATERPILLAR® EQUIPMENT

Excavators							
APPLICATION	CYL #	Misc-Parts, Instructions, etc.	CODE	ROD	BORE	KIT #	List \$
MODEL 320C							
BOOM							
AXK1-UP; BBE1-UP; BBL1-UP; BCN1-UP; BDC1-UP; BEA1-UP; BER1-UP; DBG1-UP; GLA1-UP; JTG1-UP							
1589058		Bushing	85 mm			CTC-1140756	29.72
1589058		P-UB-10	85 mm	120 mm		CTC-2366368	86.07
BBC1-UP; BCB1-UP; BEF1-UP							
2043614		Bushing	85 mm			CTC-0964402	27.84
2043614		P-UB-10	85 mm	120 mm		CTC-2043625	201.50
BBE1-UP; BBL1-UP; BCN1-UP; BEA1-UP; DBG1-UP; GLA1-UP; JTG1-UP							
1842614		P-UB-10	95 mm	160 mm		CTC-2521191	165.19
1842614		Bushing	95 mm			CTC-6C6093	38.29
BDC1-UP; BER1-UP							
1232081		Bushing	105 mm			CTC-0995572	35.65
1232081		P-UB-10	105 mm	150 mm		CTC-1373767	354.28
BDC1-UP; BER1-UP; RAW1-UP; SBN1-UP							
2043616		Bushing	100 mm			CTC-0965625	41.45
2043616		P-UB-10	100 mm	140 mm		CTC-2043626	259.02
MAB1-UP; PAB1-UP							
2742510		Bushing	85 mm			CTC-1140756	29.72
2742510		P-UB-10	85 mm	120 mm		CTC-2742511	99.56
RAW1-UP; SBN1-UP							
1589058		Bushing	85 mm			CTC-1140756	29.72
1589058		P-UB-10	85 mm	120 mm		CTC-1589092	154.26
BUCKET							
ALF1-UP; BCB1-UP; BDC1-UP; BER1-UP							
1346987		Bushing	65 mm			CTC-1140754	20.58
1346987		P-UB-10	65 mm	100 mm		CTC-1764935	187.18
AMC1-UP; ANB1-UP							
1588995		Bushing	100 mm			CTC-0965625	41.45
1588995		P-UB-10	100 mm	140 mm		CTC-1373764	272.99
2043618		Bushing	85 mm			CTC-0964402	27.84
2043618		P-UB-10	85 mm	125 mm		CTC-2479005	127.30
2836132		Bushing	85 mm			CTC-1140756	29.72
2836132		P-UB-10	85 mm	120 mm		CTC-2366368	86.07
AMC1-UP; ANB1-UP; AXK1-UP; BBE1-UP; BBL1-UP; BCN1-UP; BEA1-UP; DBG1-UP; GLA1-UP; JTG1-UP							
1589061		Bushing	85 mm			CTC-1140756	29.72
1589061		P-U-10	85 mm	120 mm		CTC-2366389	86.07
AMC1-UP; ANB1-UP; BBC1-UP; BEF1-UP							
1589088		Bushing	85 mm			CTC-0964402	27.84
1589088		P-UB-10	85 mm	125 mm		CTC-1850223	140.17
AMC1-UP; ANB1-UP; BPR1-UP; BRXI-UP; GNG1-UP; HKT1-UP; MAB1-UP; PAB1-UP							
2043689		Bushing	85 mm			CTC-0964402	27.84
2043689		P-UB-10	85 mm	120 mm		CTC-2479001	125.36
AMC1-UP; ANB1-UP; GHA1-UP; GNG1-UP; HBC1-UP; HKT1-UP; MAB1-UP; PAB1-UP							
1799793		Bushing	90 mm			CTC-1052575	26.85
1799793		P-UB-10	90 mm	130 mm		CTC-2590626	118.68
2043696		Bushing	85 mm			CTC-0964402	27.84
2043696		P-UB-10	85 mm	120 mm		CTC-2479000	125.36

CATERPILLAR®



REPLACEMENT KITS FOR CATERPILLAR® EQUIPMENT

Excavators							
APPLICATION	CYL #	Misc-Parts, Instructions, etc.	CODE	ROD	BORE	KIT #	List \$
MODEL 320C							
BUCKET							
AMC1-UP; ANB1-UP; GHA1-UP; HBC1-UP							
1850346			Bushing	85 mm		CTC-0964402	27.84
1850346			P-UB-10	85 mm	120 mm	CTC-1540744	396.77
AMC1-UP; ANB1-UP; MAB1-UP; PAB1-UP							
2096011			Bushing	90 mm		CTC-1052575	26.85
2096011			P-UB-10	90 mm	130 mm	CTC-2590627	118.68
2590694			Bushing	85 mm		CTC-0964402	27.84
2590694			P-UB-10	85 mm	120 mm	CTC-2590695	137.75
2590698			Bushing	100 mm		CTC-0965625	41.45
2590698			P-UB-10	100 mm	140 mm	CTC-2590699	130.38
2590705			Bushing	85 mm		CTC-0964402	27.84
2590705			P-UB-10	85 mm	120 mm	CTC-2590706	125.36
2590732			Bushing	90 mm		CTC-1052575	26.85
2590732			P-UB-10	90 mm	130 mm	CTC-2590719	120.10
AMC1-UP; ANB1-UP; RAW1-UP; SBN1-UP							
1588999			Bushing	90 mm		CTC-1052575	26.85
1588999			P-UB-10	90 mm	130 mm	CTC-1850196	139.69
AXK1-UP							
1799764			Bushing	90 mm		CTC-1140758	34.28
1799764			P-UB-10	90 mm	130 mm	CTC-2159986	105.79
BBC1-UP; BCB1-UP; BEF1-UP							
2043618			Bushing	85 mm		CTC-0964402	27.84
2043618			P-UB-10	85 mm	125 mm	CTC-2043628	127.30
BBC1-UP; BCB1-UP; BEF1-UP; BPR1-UP; BRXI-UP; RAW1-UP; SBN1-UP; AMC1-UP; ANB1-UP							
2043617			Bushing	85 mm		CTC-0964402	27.84
2043617			P-UB-10	85 mm	120 mm	CTC-2043627	118.30
BBE1-UP; BBL1-UP; BCN1-UP; BEA1-UP; DBG1-UP; GLA1-UP; JTG1-UP							
1799764			Bushing	90 mm		CTC-1140758	34.28
1799764			P-UB-10	90 mm	130 mm	CTC-2159986	105.79
2836132			Bushing	85 mm		CTC-1140756	29.72
2836132			P-UB-10	85 mm	120 mm	CTC-2366368	86.07
BCB1-UP							
2043689			Bushing	85 mm		CTC-0964402	27.84
2043689			P-UB-10	85 mm	120 mm	CTC-2043692	125.36
2096011			Bushing	90 mm		CTC-1052575	26.85
2096011			P-UB-10	90 mm	130 mm	CTC-2043630	214.11
BDC1-UP; BER1-UP; RAW1-UP; SBN1-UP							
1589061			Bushing	85 mm		CTC-1140756	29.72
1589061			P-UB-10	85 mm	120 mm	CTC-1589092	154.26
1799764			Bushing	90 mm		CTC-1140758	34.28
1799764			P-UB-10	90 mm	130 mm	CTC-1799772	174.88
BPR1-UP; BRXI-UP							
1588997			Bushing	85 mm		CTC-0964402	27.84
1588997			P-UB-10	85 mm	120 mm	CTC-1261947	292.79
MAB1-UP; PAB1-UP							
2742521			Bushing	85 mm		CTC-1140756	29.72
2742521			P-UB-10	85 mm	120 mm	CTC-2742511	99.56



REPLACEMENT KITS FOR CATERPILLAR® EQUIPMENT

Excavators							
APPLICATION	CYL #	Misc-Parts, Instructions, etc.	CODE	ROD	BORE	KIT #	List \$
MODEL 320C							
STICK							
AMC1-UP; ANB1-UP; BBC1-UP; BCB1-UP; BEF1-UP; MAB1-UP; PAB1-UP							
2043615			Bushing	100 mm		CTC-0965625	41.45
2043615			P-UB-10	100 mm	140 mm	CTC-2043626	259.02
AMC1-UP; ANB1-UP; BBC1-UP; BEF1-UP; BPR1-UP; BRXI-UP; RAW1-UP; SBN1-UP							
1588993			Bushing	100 mm		CTC-0965625	41.45
1588993			P-UB-10	100 mm	140 mm	CTC-1373764	272.99
AMC1-UP; ANB1-UP; BPR1-UP; BRXI-UP; GNG1-UP; HKT1-UP; MAB1-UP; PAB1-UP							
2144500			Bushing	100 mm		CTC-0965625	41.45
2144500			P-UB-10	100 mm	140 mm	CTC-2590635	130.38
AMC1-UP; ANB1-UP; GHA1-UP; GNG1-UP; HBC1-UP; HKT1-UP; MAB1-UP; PAB1-UP							
1850342			Bushing	100 mm		CTC-0965625	41.45
1850342			P-UB-10	100 mm	140 mm	CTC-2590631	130.38
1850344			Bushing	100 mm		CTC-0965625	41.45
1850344			P-UB-10	100 mm	140 mm	CTC-2590631	130.38
AXK1-UP							
1589059			Bushing	100 mm		CTC-1140757	41.78
1589059			P-UB-10	100 mm	140 mm	CTC-2159985	103.63
AXK1-UP; BBE1-UP; BBL1-UP; BCN1-UP; BEA1-UP; DBG1-UP; GLA1-UP; JTG1-UP							
1589060			Bushing	100 mm		CTC-1140757	41.78
1589060			P-UB-10	100 mm	140 mm	CTC-2159985	103.63
BBC1-UP; BCB1-UP; BEF1-UP							
2144500			Bushing	100 mm		CTC-0965625	41.45
2144500			P-UB-10	100 mm	140 mm	CTC-2144502	130.38
BBE1-UP; BBL1-UP; BCN1-UP; BEA1-UP; DBG1-UP; GLA1-UP; JTG1-UP							
1589059			Bushing	100 mm		CTC-1140757	41.78
1589059			P-UB-10	100 mm	140 mm	CTC-2095874	214.88
BCB1-UP							
1232081			Bushing	105 mm		CTC-0995572	35.65
1232081			P-UB-10	105 mm	150 mm	CTC-1373767	354.28
2043616			Bushing	100 mm		CTC-0965625	41.45
2043616			P-UB-10	100 mm	140 mm	CTC-2043616	130.38
BDC1-UP; BER1-UP; RAW1-UP; SBN1-UP							
1589059			Bushing	100 mm		CTC-1140757	41.78
1589059			P-UB-10	100 mm	140 mm	CTC-2159985	103.63
1589060			Bushing	100 mm		CTC-1140757	41.78
1589060			P-UB-10	100 mm	140 mm	CTC-2095874	214.88
BPR1-UP; BRXI-UP; GNG1-UP; HKT1-UP							
2043615			Bushing	100 mm		CTC-0965625	41.45
2043615			P-UB-10	100 mm	140 mm	CTC-2590633	130.38
MAB1-UP; PAB1-UP							
2742514			Bushing	100 mm		CTC-1140757	41.78
2742514			P-UB-10	100 mm	140 mm	CTC-2742515	143.27
RAW1-UP; SBN1-UP							
2043615			Bushing	100 mm		CTC-0965625	41.45
2043615			P-UB-10	100 mm	140 mm	CTC-1373764	272.99

CATERPILLAR®



REPLACEMENT KITS FOR CATERPILLAR® EQUIPMENT

Excavators							
APPLICATION	CYL #	Misc-Parts, Instructions, etc.	CODE	ROD	BORE	KIT #	List \$
MODEL 320C							
UNSPECIFIED APPLICATION							
AKH1-UP; ALF1-UP							
1980648			I-U-10	45 mm	60 mm	CTC-1980648K	39.60
BBE1-UP; BBL1-UP; BCN1-UP; BEA1-UP							
1702109			I-UB-10	125 mm	220 mm	CTC-1702156	735.85
MODEL 320C L							
BOOM							
AMC1-UP; ANB1-UP; BBC1-UP; BDC1-UP; BEF1-UP; BER1-UP; BPR1-UP; BRXI-UP							
1588991			Bushing	85 mm		CTC-0964402	27.84
1588991			P-UB-10	85 mm	120 mm	CTC-1373763	312.80
AMC1-UP; ANB1-UP; BDC1-UP; BER1-UP; BPR1-UP; BRXI-UP; EAG1-UP; GNG1-UP; HKT1-UP; MAB1-UP; PAB1-UP; RAW1-UP; SBN1-UP							
2043614			Bushing	85 mm		CTC-0964402	27.84
2043614			P-UB-10	85 mm	120 mm	CTC-2478998	137.75
AMC1-UP; ANB1-UP; GHA1-UP; GNG1-UP; HBC1-UP; HKT1-UP; MAB1-UP; PAB1-UP							
1850340			Bushing	85 mm		CTC-0964402	27.84
1850340			P-UB-10	85 mm	120 mm	CTC-2478996	137.75
AMC1-UP; ANB1-UP; MAB1-UP; PAB1-UP							
2043616			Bushing	100 mm		CTC-0965625	41.45
2043616			P-UB-10	100 mm	140 mm	CTC-2590633	130.38
2590702			Bushing	100 mm		CTC-0965625	41.45
2590702			P-UB-10	100 mm	140 mm	CTC-2590699	130.38
AXK1-UP							
1842614			P-UB-10	95 mm	160 mm	CTC-2521191	165.19
1842614			Bushing	95 mm		CTC-6C6093	38.29
AXK1-UP; BBE1-UP; BBL1-UP; BCN1-UP; BDC1-UP; BEA1-UP; BER1-UP; DBG1-UP; GLA1-UP; JTG1-UP							
1589058			Bushing	85 mm		CTC-1140756	29.72
1589058			P-UB-10	85 mm	120 mm	CTC-2366368	86.07
BBC1-UP; BCB1-UP; BEF1-UP							
2043614			Bushing	85 mm		CTC-0964402	27.84
2043614			P-UB-10	85 mm	120 mm	CTC-2043625	201.50
BBE1-UP; BBL1-UP; BCN1-UP; BEA1-UP; DBG1-UP; GLA1-UP; JTG1-UP							
1842614			P-UB-10	95 mm	160 mm	CTC-2521191	165.19
1842614			Bushing	95 mm		CTC-6C6093	38.29
BDC1-UP; BER1-UP							
1232081			Bushing	105 mm		CTC-0995572	35.65
1232081			P-UB-10	105 mm	150 mm	CTC-1373767	354.28
BDC1-UP; BER1-UP; RAW1-UP; SBN1-UP							
2043616			Bushing	100 mm		CTC-0965625	41.45
2043616			P-UB-10	100 mm	140 mm	CTC-2043626	259.02
MAB1-UP; PAB1-UP							
2742510			Bushing	85 mm		CTC-1140756	29.72
2742510			P-UB-10	85 mm	120 mm	CTC-2742511	99.56
RAW1-UP; SBN1-UP							
1589058			Bushing	85 mm		CTC-1140756	29.72
1589058			P-UB-10	85 mm	120 mm	CTC-1589092	154.26



REPLACEMENT KITS FOR CATERPILLAR® EQUIPMENT

Excavators							
APPLICATION	CYL #	Misc-Parts, Instructions, etc.	CODE	ROD	BORE	KIT #	List \$
MODEL 320C L							
BUCKET							
ALF1-UP; BCB1-UP; BDC1-UP; BER1-UP							
1346987		Bushing	65 mm			CTC-1140754	20.58
1346987		P-UB-10	65 mm	100 mm		CTC-1764935	187.18
AMC1-UP; ANB1-UP							
1588995		Bushing	100 mm			CTC-0965625	41.45
1588995		P-UB-10	100 mm	140 mm		CTC-1373764	272.99
2043618		Bushing	85 mm			CTC-0964402	27.84
2043618		P-UB-10	85 mm	125 mm		CTC-2479005	127.30
2590705		Bushing	85 mm			CTC-0964402	27.84
2590705		P-UB-10	85 mm	120 mm		CTC-2590706	125.36
2836132		Bushing	85 mm			CTC-1140756	29.72
2836132		P-UB-10	85 mm	120 mm		CTC-2366368	86.07
AMC1-UP; ANB1-UP; AXK1-UP; BBE1-UP; BBL1-UP; BCN1-UP; BEA1-UP; DBG1-UP; GLA1-UP; JTG1-UP							
1589061		Bushing	85 mm			CTC-1140756	29.72
1589061		P-U-10	85 mm	120 mm		CTC-2366389	86.07
AMC1-UP; ANB1-UP; BBC1-UP; BEF1-UP							
1589088		Bushing	85 mm			CTC-0964402	27.84
1589088		P-UB-10	85 mm	125 mm		CTC-1850223	140.17
AMC1-UP; ANB1-UP; BPR1-UP; BRXI-UP; EAG1-UP; GNG1-UP; HKT1-UP; MAB1-UP; PAB1-UP							
2043689		Bushing	85 mm			CTC-0964402	27.84
2043689		P-UB-10	85 mm	120 mm		CTC-2479001	125.36
AMC1-UP; ANB1-UP; GHA1-UP; GNG1-UP; HBC1-UP; HKT1-UP; MAB1-UP; PAB1-UP							
1799793		Bushing	90 mm			CTC-1052575	26.85
1799793		P-UB-10	90 mm	130 mm		CTC-2590626	118.68
2043696		Bushing	85 mm			CTC-0964402	27.84
2043696		P-UB-10	85 mm	120 mm		CTC-2479000	125.36
AMC1-UP; ANB1-UP; GHA1-UP; HBC1-UP							
1850346		Bushing	85 mm			CTC-0964402	27.84
1850346		P-UB-10	85 mm	120 mm		CTC-1540744	396.77
AMC1-UP; ANB1-UP; MAB1-UP; PAB1-UP							
2096011		Bushing	90 mm			CTC-1052575	26.85
2096011		P-UB-10	90 mm	130 mm		CTC-2590627	118.68
2590694		Bushing	85 mm			CTC-0964402	27.84
2590694		P-UB-10	85 mm	120 mm		CTC-2590695	137.75
2590698		Bushing	100 mm			CTC-0965625	41.45
2590698		P-UB-10	100 mm	140 mm		CTC-2590699	130.38
2590732		Bushing	90 mm			CTC-1052575	26.85
2590732		P-UB-10	90 mm	130 mm		CTC-2590719	120.10
AMC1-UP; ANB1-UP; RAW1-UP; SBN1-UP							
1588999		Bushing	90 mm			CTC-1052575	26.85
1588999		P-UB-10	90 mm	130 mm		CTC-1850196	139.69
AXK1-UP							
1799764		Bushing	90 mm			CTC-1140758	34.28
1799764		P-UB-10	90 mm	130 mm		CTC-2159986	105.79
BBC1-UP; BCB1-UP; BEF1-UP							
2043618		Bushing	85 mm			CTC-0964402	27.84
2043618		P-UB-10	85 mm	125 mm		CTC-2043628	127.30

CATERPILLAR®



REPLACEMENT KITS FOR CATERPILLAR® EQUIPMENT

Excavators							
APPLICATION	CYL #	Misc-Parts, Instructions, etc.	CODE	ROD	BORE	KIT #	List \$
MODEL 320C L							
BUCKET							
BBC1-UP; BEF1-UP							
2043617		Bushing	85 mm			CTC-0964402	27.84
2043617		P-UB-10	85 mm	120 mm		CTC-2043627	118.30
BBE1-UP; BBL1-UP; BCN1-UP; BEA1-UP; DBG1-UP; GLA1-UP; JTG1-UP							
1799764		Bushing	90 mm			CTC-1140758	34.28
1799764		P-UB-10	90 mm	130 mm		CTC-2159986	105.79
2836132		Bushing	85 mm			CTC-1140756	29.72
2836132		P-UB-10	85 mm	120 mm		CTC-2366368	86.07
BCB1-UP							
2043689		Bushing	85 mm			CTC-0964402	27.84
2043689		P-UB-10	85 mm	120 mm		CTC-2043692	125.36
2096011		Bushing	90 mm			CTC-1052575	26.85
2096011		P-UB-10	90 mm	130 mm		CTC-2043630	214.11
BCB1-UP; BPR1-UP; BRXI-UP; RAW1-UP; SBN1-UP; AMC1-UP; ANB1-UP							
2043617		Bushing	85 mm			CTC-0964402	27.84
2043617		P-UB-10	85 mm	120 mm		CTC-2043627	118.30
BDC1-UP; BER1-UP; RAW1-UP; SBN1-UP							
1589061		Bushing	85 mm			CTC-1140756	29.72
1589061		P-UB-10	85 mm	120 mm		CTC-1589092	154.26
1799764		Bushing	90 mm			CTC-1140758	34.28
1799764		P-UB-10	90 mm	130 mm		CTC-1799772	174.88
BPR1-UP; BRXI-UP							
1588997		Bushing	85 mm			CTC-0964402	27.84
1588997		P-UB-10	85 mm	120 mm		CTC-1261947	292.79
MAB1-UP; PAB1-UP							
2590705		Bushing	85 mm			CTC-0964402	27.84
2590705		P-UB-10	85 mm	120 mm		CTC-2590706	125.36
2742521		Bushing	85 mm			CTC-1140756	29.72
2742521		P-UB-10	85 mm	120 mm		CTC-2742511	99.56
STICK							
AMC1-UP; ANB1-UP; BBC1-UP; BCB1-UP; BEF1-UP; MAB1-UP; PAB1-UP							
2043615		Bushing	100 mm			CTC-0965625	41.45
2043615		P-UB-10	100 mm	140 mm		CTC-2043626	259.02
AMC1-UP; ANB1-UP; BBC1-UP; BEF1-UP; BPR1-UP; BRXI-UP; RAW1-UP; SBN1-UP							
1588993		Bushing	100 mm			CTC-0965625	41.45
1588993		P-UB-10	100 mm	140 mm		CTC-1373764	272.99
AMC1-UP; ANB1-UP; BPR1-UP; BRXI-UP; GNG1-UP; HKT1-UP; MAB1-UP; PAB1-UP							
2144500		Bushing	100 mm			CTC-0965625	41.45
2144500		P-UB-10	100 mm	140 mm		CTC-2590635	130.38
AMC1-UP; ANB1-UP; GHA1-UP; GNG1-UP; HBC1-UP; HKT1-UP; MAB1-UP; PAB1-UP							
1850342		Bushing	100 mm			CTC-0965625	41.45
1850342		P-UB-10	100 mm	140 mm		CTC-2590631	130.38
1850344		Bushing	100 mm			CTC-0965625	41.45
1850344		P-UB-10	100 mm	140 mm		CTC-2590631	130.38
AXK1-UP							
1589059		Bushing	100 mm			CTC-1140757	41.78
1589059		P-UB-10	100 mm	140 mm		CTC-2159985	103.63



REPLACEMENT KITS FOR CATERPILLAR® EQUIPMENT

Excavators							
APPLICATION	CYL #	Misc-Parts, Instructions, etc.	CODE	ROD	BORE	KIT #	List \$
MODEL 320C L							
STICK							
AXK1-UP; BBE1-UP; BBL1-UP; BCN1-UP; BEA1-UP; DBG1-UP; GLA1-UP; JTG1-UP							
1589060		Bushing		100 mm		CTC-1140757	41.78
1589060		P-UB-10		100 mm	140 mm	CTC-2159985	103.63
BBC1-UP; BCB1-UP; BEF1-UP							
2144500		Bushing		100 mm		CTC-0965625	41.45
2144500		P-UB-10		100 mm	140 mm	CTC-2144502	130.38
BBE1-UP; BBL1-UP; BCN1-UP; BEA1-UP; DBG1-UP; GLA1-UP; JTG1-UP							
1589059		Bushing		100 mm		CTC-1140757	41.78
1589059		P-UB-10		100 mm	140 mm	CTC-2095874	214.88
BCB1-UP							
1232081		Bushing		105 mm		CTC-0995572	35.65
1232081		P-UB-10		105 mm	150 mm	CTC-1373767	354.28
2043616		Bushing		100 mm		CTC-0965625	41.45
2043616		P-UB-10		100 mm	140 mm	CTC-2043616	130.38
BDC1-UP; BER1-UP; RAW1-UP; SBN1-UP							
1589059		Bushing		100 mm		CTC-1140757	41.78
1589059		P-UB-10		100 mm	140 mm	CTC-2159985	103.63
1589060		Bushing		100 mm		CTC-1140757	41.78
1589060		P-UB-10		100 mm	140 mm	CTC-2095874	214.88
BPR1-UP; BRXI-UP; EAG1-UP; GNG1-UP; HKT1-UP							
2043615		Bushing		100 mm		CTC-0965625	41.45
2043615		P-UB-10		100 mm	140 mm	CTC-2590633	130.38
EAG1-UP							
2144500		P-UB-10		100 mm	140 mm	CTC-2590635	130.38
MAB1-UP; PAB1-UP							
2742514		Bushing		100 mm		CTC-1140757	41.78
2742514		P-UB-10		100 mm	140 mm	CTC-2742515	143.27
RAW1-UP; SBN1-UP							
2043615		Bushing		100 mm		CTC-0965625	41.45
2043615		P-UB-10		100 mm	140 mm	CTC-1373764	272.99
UNSPECIFIED APPLICATION							
AKH1-UP; ALF1-UP							
1980648		I-U-10		45 mm	60 mm	CTC-1980648K	39.60
BBE1-UP; BBL1-UP; BCN1-UP; BEA1-UP							
1702109		I-UB-10		125 mm	220 mm	CTC-1702156	735.85
MODEL 320C LN							
BOOM							
BBE1-UP; BBL1-UP; BCN1-UP; BEA1-UP; DBG1-UP; GLA1-UP; JTG1-UP							
1589058		Bushing		85 mm		CTC-1140756	29.72
1589058		P-UB-10		85 mm	120 mm	CTC-2366368	86.07
1842614		P-UB-10		95 mm	160 mm	CTC-2521191	165.19
1842614		Bushing		95 mm		CTC-6C6093	38.29

CATERPILLAR®



REPLACEMENT KITS FOR CATERPILLAR® EQUIPMENT

Excavators							
APPLICATION	CYL #	Misc-Parts, Instructions, etc.	CODE	ROD	BORE	KIT #	List \$
MODEL 320C LN							
BUCKET							
BBE1-UP; BBL1-UP; BCN1-UP; BEA1-UP; DBG1-UP; GLA1-UP; JTG1-UP							
1589061		Bushing	85 mm			CTC-1140756	29.72
1589061		P-U-10	85 mm	120 mm		CTC-2366389	86.07
1799764		Bushing	90 mm			CTC-1140758	34.28
1799764		P-UB-10	90 mm	130 mm		CTC-2159986	105.79
2836132		Bushing	85 mm			CTC-1140756	29.72
2836132		P-UB-10	85 mm	120 mm		CTC-2366368	86.07
STICK							
BBE1-UP; BBL1-UP; BCN1-UP; BEA1-UP; DBG1-UP; GLA1-UP; JTG1-UP							
1589059		Bushing	100 mm			CTC-1140757	41.78
1589059		P-UB-10	100 mm	140 mm		CTC-2095874	214.88
1589060		Bushing	100 mm			CTC-1140757	41.78
1589060		P-UB-10	100 mm	140 mm		CTC-2159985	103.63
UNSPECIFIED APPLICATION							
BBE1-UP; BBL1-UP; BCN1-UP; BEA1-UP							
1702109		I-UB-10	125 mm	220 mm		CTC-1702156	735.85
MODEL 320C LRR							
BOOM							
GAD1-UP							
1589058		Bushing	85 mm			CTC-1140756	29.72
1589058		P-UB-10	85 mm	120 mm		CTC-2366368	86.07
STICK							
GAD1-UP							
1589059		Bushing	100 mm			CTC-1140757	41.78
1589059		P-UB-10	100 mm	140 mm		CTC-2159985	103.63
MODEL 320C LU							
BOOM							
CLM1-UP; CLZ1-UP							
1588991		Bushing	85 mm			CTC-0964402	27.84
1588991		P-UB-10	85 mm	120 mm		CTC-1373763	312.80
CLM1-UP; CLZ1-UP; MAC1-UP; PAC1-UP							
1850340		Bushing	85 mm			CTC-0964402	27.84
1850340		P-UB-10	85 mm	120 mm		CTC-2478996	137.75
2043614		Bushing	85 mm			CTC-0964402	27.84
2043614		P-UB-10	85 mm	120 mm		CTC-2478998	137.75
MAC1-UP; PAC1-UP							
2742510		Bushing	85 mm			CTC-1140756	29.72
2742510		P-UB-10	85 mm	120 mm		CTC-2742511	99.56
BUCKET							
CLM1-UP; CLZ1-UP							
1850346		Bushing	85 mm			CTC-0964402	27.84
1850346		P-UB-10	85 mm	120 mm		CTC-1540744	396.77
2043617		Bushing	85 mm			CTC-0964402	27.84
2043617		P-UB-10	85 mm	120 mm		CTC-2043627	118.30
2043696		Bushing	85 mm			CTC-0964402	27.84
2043696		P-UB-10	85 mm	120 mm		CTC-2479000	125.36



REPLACEMENT KITS FOR CATERPILLAR® EQUIPMENT

Excavators							
APPLICATION	CYL #	Misc-Parts, Instructions, etc.	CODE	ROD	BORE	KIT #	List \$
MODEL 320C LU							
BUCKET							
CLM1-UP; CLZ1-UP; MAC1-UP; PAC1-UP							
2043689		Bushing	85 mm			CTC-0964402	27.84
2043689		P-UB-10	85 mm	120 mm		CTC-2479001	125.36
MAC1-UP; PAC1-UP							
2590694		Bushing	85 mm			CTC-0964402	27.84
2590694		P-UB-10	85 mm	120 mm		CTC-2590695	137.75
2590698		Bushing	100 mm			CTC-0965625	41.45
2590698		P-UB-10	100 mm	140 mm		CTC-2590699	130.38
2590705		Bushing	85 mm			CTC-0964402	27.84
2590705		P-UB-10	85 mm	120 mm		CTC-2590706	125.36
2742521		Bushing	85 mm			CTC-1140756	29.72
2742521		P-UB-10	85 mm	120 mm		CTC-2742511	99.56
STICK							
CLM1-UP; CLZ1-UP							
1588993		Bushing	100 mm			CTC-0965625	41.45
1588993		P-UB-10	100 mm	140 mm		CTC-1373764	272.99
CLM1-UP; CLZ1-UP; MAC1-UP; PAC1-UP							
1850342		Bushing	100 mm			CTC-0965625	41.45
1850342		P-UB-10	100 mm	140 mm		CTC-2590631	130.38
2043615		Bushing	100 mm			CTC-0965625	41.45
2043615		P-UB-10	100 mm	140 mm		CTC-2590633	130.38
MAC1-UP; PAC1-UP							
2742514		Bushing	100 mm			CTC-1140757	41.78
2742514		P-UB-10	100 mm	140 mm		CTC-2742515	143.27
MODEL 320C S							
BOOM							
BBE1-UP; BBL1-UP; BCN1-UP; BEA1-UP; BMZ1-UP; EGL1-UP							
1589058		Bushing	85 mm			CTC-1140756	29.72
1589058		P-UB-10	85 mm	120 mm		CTC-2366368	86.07
BBE1-UP; BBL1-UP; BCN1-UP; BEA1-UP; EGL1-UP							
1842614		P-UB-10	95 mm	160 mm		CTC-2521191	165.19
1842614		Bushing	95 mm			CTC-6C6093	38.29
BMZ1-UP							
1842614		P-UB-10	95 mm	160 mm		CTC-2521191	165.19
1842614		Bushing	95 mm			CTC-6C6093	38.29
BUCKET							
BBE1-UP; BBL1-UP; BCN1-UP; BEA1-UP; BMZ1-UP; EGL1-UP							
1589061		Bushing	85 mm			CTC-1140756	29.72
1589061		P-U-10	85 mm	120 mm		CTC-2366389	86.07
BBE1-UP; BBL1-UP; BCN1-UP; BEA1-UP; EGL1-UP							
1799764		Bushing	90 mm			CTC-1140758	34.28
1799764		P-UB-10	90 mm	130 mm		CTC-2159986	105.79
2836132		Bushing	85 mm			CTC-1140756	29.72
2836132		P-UB-10	85 mm	120 mm		CTC-2366368	86.07
BMZ1-UP							
1799764		Bushing	90 mm			CTC-1140758	34.28
1799764		P-UB-10	90 mm	130 mm		CTC-2159986	105.79

CATERPILLAR®



REPLACEMENT KITS FOR CATERPILLAR® EQUIPMENT

Excavators							
APPLICATION	CYL #	Misc-Parts, Instructions, etc.	CODE	ROD	BORE	KIT #	List \$
MODEL 320C S							
STICK							
BBE1-UP; BBL1-UP; BCN1-UP; BEA1-UP; BMZ1-UP; EGL1-UP							
1589060		Bushing		100 mm		CTC-1140757	41.78
1589060		P-UB-10		100 mm	140 mm	CTC-2159985	103.63
BBE1-UP; BBL1-UP; BCN1-UP; BEA1-UP; EGL1-UP							
1589059		Bushing		100 mm		CTC-1140757	41.78
1589059		P-UB-10		100 mm	140 mm	CTC-2095874	214.88
BMZ1-UP							
1589059		Bushing		100 mm		CTC-1140757	41.78
1589059		P-UB-10		100 mm	140 mm	CTC-2159985	103.63
UNSPECIFIED APPLICATION							
BBE1-UP; BBL1-UP; BCN1-UP; BEA1-UP							
1702109		I-UB-10		125 mm	220 mm	CTC-1702156	735.85
MODEL 320C U							
BOOM							
CLM1-UP; CLZ1-UP							
1588991		Bushing		85 mm		CTC-0964402	27.84
1588991		P-UB-10		85 mm	120 mm	CTC-1373763	312.80
CLM1-UP; CLZ1-UP; MAC1-UP; PAC1-UP							
1850340		Bushing		85 mm		CTC-0964402	27.84
1850340		P-UB-10		85 mm	120 mm	CTC-2478996	137.75
2043614		Bushing		85 mm		CTC-0964402	27.84
2043614		P-UB-10		85 mm	120 mm	CTC-2478998	137.75
MAC1-UP; PAC1-UP							
2742510		Bushing		85 mm		CTC-1140756	29.72
2742510		P-UB-10		85 mm	120 mm	CTC-2742511	99.56
BUCKET							
CLM1-UP; CLZ1-UP							
1850346		Bushing		85 mm		CTC-0964402	27.84
1850346		P-UB-10		85 mm	120 mm	CTC-1540744	396.77
2043617		Bushing		85 mm		CTC-0964402	27.84
2043617		P-UB-10		85 mm	120 mm	CTC-2043627	118.30
2043696		Bushing		85 mm		CTC-0964402	27.84
2043696		P-UB-10		85 mm	120 mm	CTC-2479000	125.36
CLM1-UP; CLZ1-UP; MAC1-UP; PAC1-UP							
2043689		Bushing		85 mm		CTC-0964402	27.84
2043689		P-UB-10		85 mm	120 mm	CTC-2479001	125.36
MAC1-UP; PAC1-UP							
2590694		Bushing		85 mm		CTC-0964402	27.84
2590694		P-UB-10		85 mm	120 mm	CTC-2590695	137.75
2590698		Bushing		100 mm		CTC-0965625	41.45
2590698		P-UB-10		100 mm	140 mm	CTC-2590699	130.38
2590705		Bushing		85 mm		CTC-0964402	27.84
2590705		P-UB-10		85 mm	120 mm	CTC-2590706	125.36
2742521		Bushing		85 mm		CTC-1140756	29.72
2742521		P-UB-10		85 mm	120 mm	CTC-2742511	99.56



REPLACEMENT KITS FOR CATERPILLAR® EQUIPMENT

Excavators							
APPLICATION	CYL #	Misc-Parts, Instructions, etc.	CODE	ROD	BORE	KIT #	List \$
MODEL 320C U							
STICK							
CLM1-UP; CLZ1-UP							
1588993		Bushing		100 mm		CTC-0965625	41.45
1588993		P-UB-10		100 mm	140 mm	CTC-1373764	272.99
CLM1-UP; CLZ1-UP; MAC1-UP; PAC1-UP							
1850342		Bushing		100 mm		CTC-0965625	41.45
1850342		P-UB-10		100 mm	140 mm	CTC-2590631	130.38
2043615		Bushing		100 mm		CTC-0965625	41.45
2043615		P-UB-10		100 mm	140 mm	CTC-2590633	130.38
MAC1-UP; PAC1-UP							
2742514		Bushing		100 mm		CTC-1140757	41.78
2742514		P-UB-10		100 mm	140 mm	CTC-2742515	143.27
MODEL 320D							
BOOM							
A6F1-UP; A8F1-UP; CXY1-UP; DHK1-UP; FAL1-UP; JFZ1-UP; JGZ1-UP; KGF1-UP; MCH1-UP; MDE1-UP; MGG1-UP; PHX1-UP							
2426731		Bushing		85 mm		CTC-0964402	27.84
2426731		P-UB-10		85 mm	120 mm	CTC-2478868	135.35
A6F1-UP; A8F1-UP; CXY1-UP; DHK1-UP; FAL1-UP; KGF1-UP; MCH1-UP; PHX1-UP							
2426751		Bushing		100 mm		CTC-0965625	41.45
2426751		P-UB-10		100 mm	140 mm	CTC-2478878	166.54
CXY1-UP; DHK1-UP							
2426746		P-UB-10		85 mm	120 mm	CTC-2667891	135.35
2667972		Bushing		85 mm		CTC-0964402	27.84
2667972		P-UB-10		85 mm	120 mm	CTC-2668011	135.35
FAL1-UP; KGF1-UP							
2426746		Bushing		85 mm		CTC-0964402	27.84
2426746		P-UB-10		85 mm	120 mm	CTC-2667891	135.35
GKS1-UP							
2897752		Bushing		100 mm		CTC-0965625	41.45
2897752		P-UB-10		100 mm	140 mm	CTC-2344566	123.68
JGZ1-UP; MDE1-UP; BZP1-UP							
2426746		Bushing		85 mm		CTC-0964402	27.84
2426746		P-UB-10		85 mm	120 mm	CTC-2667891	135.35
BUCKET							
A6F1-UP; A8F1-UP; CXY1-UP; DHK1-UP; FAL1-UP; JFZ1-UP; JGZ1-UP; KGF1-UP; MCH1-UP; MDE1-UP; MGG1-UP; PHX1-UP							
2426756		Bushing		85 mm		CTC-0964402	27.84
2426756		P-UB-10		85 mm	120 mm	CTC-2478888	115.90
A6F1-UP; A8F1-UP; CXY1-UP; DHK1-UP; FAL1-UP; KGF1-UP; MCH1-UP; PHX1-UP							
2254591		Bushing		95 mm		CTC-0964430	30.24
2254591		P-UB-10		95 mm	135 mm	CTC-2344587	113.49
BZP1-UP; CXY1-UP; DHK1-UP; FAL1-UP; JGZ1-UP; KGF1-UP; MDE1-UP							
2426759		Bushing		85 mm		CTC-0964402	27.84
2426759		P-UB-10		85 mm	120 mm	CTC-2667892	115.90
CXY1-UP; DHK1-UP							
2667978		Bushing		85 mm		CTC-0964402	27.84
2667978		P-UB-10		85 mm	120 mm	CTC-2668057	115.90

CATERPILLAR®



REPLACEMENT KITS FOR CATERPILLAR® EQUIPMENT

Excavators							
APPLICATION	CYL #	Misc-Parts, Instructions, etc.	CODE	ROD	BORE	KIT #	List \$
MODEL 320D							
BUCKET							
CXY1-UP; DHK1-UP; FAL1-UP; JGZ1-UP; KGF1-UP; MDE1-UP							
2254599		Bushing		95 mm		CTC-0964430	30.24
2254599		P-UB-10		95 mm	135 mm	CTC-2590656	112.38
CAB TILT							
GKS1-UP							
2632914		P-UB-10		2-1/4	5	CTC-2417578	53.84
HEEL							
GKS1-UP							
2897756		Bushing		90 mm		CTC-1052575	26.85
2897756		P-UB-10		90 mm	130 mm	CTC-2590678	110.14
STICK							
A6F1-UP; A8F1-UP; CXY1-UP; DHK1-UP; FAL1-UP; JFZ1-UP; JGZ1-UP; KGF1-UP; MCH1-UP; MDE1-UP; MGG1-UP; PHX1-UP							
2426744		Bushing		100 mm		CTC-0965625	41.45
2426744		P-UB-10		100 mm	140 mm	CTC-2478974	166.54
A6F1-UP; A8F1-UP; CXY1-UP; DHK1-UP; FAL1-UP; KGF1-UP; MCH1-UP; PHX1-UP							
2426734		Bushing		100 mm		CTC-0965625	41.45
2426734		P-UB-10		100 mm	140 mm	CTC-2478878	166.54
BZP1-UP; CXY1-UP; DHK1-UP; FAL1-UP; JGZ1-UP; KGF1-UP; MDE1-UP							
2426748		Bushing		100 mm		CTC-0965625	41.45
2426748		P-UB-10		100 mm	140 mm	CTC-2590775	166.54
CXY1-UP; DHK1-UP							
2667974		Bushing		100 mm		CTC-0965625	41.45
2667974		P-UB-10		100 mm	140 mm	CTC-2668012	166.54
CXY1-UP; DHK1-UP; FAL1-UP; JGZ1-UP; KGF1-UP; MDE1-UP							
2426763		Bushing		100 mm		CTC-0965625	41.45
2426763		P-UB-10		100 mm	140 mm	CTC-2590775	166.54
GKS1-UP							
2897754		Bushing		105 mm		CTC-0995572	35.65
2897754		P-UB-10		105 mm	150 mm	CTC-2344576	284.06
MODEL 320D L							
BOOM							
A6F1-UP; A8F1-UP; A9F1-UP; CXY1-UP; DHK1-UP; FAL1-UP; KGF1-UP; MCH1-UP; PHX1-UP							
2426751		Bushing		100 mm		CTC-0965625	41.45
2426751		P-UB-10		100 mm	140 mm	CTC-2478878	166.54
A6F1-UP; A8F1-UP; CXY1-UP; DHK1-UP; FAL1-UP; JFZ1-UP; JGZ1-UP; KGF1-UP; MCH1-UP; MDE1-UP; MGG1-UP; PHX1-UP							
2426731		Bushing		85 mm		CTC-0964402	27.84
2426731		P-UB-10		85 mm	120 mm	CTC-2478868	135.35
A9F1-UP							
2426731		Bushing		85 mm		CTC-0964402	27.84
2426731		P-UB-10		85 mm	120 mm	CTC-2478868	135.35
CXY1-UP; DHK1-UP							
2426746		P-UB-10		85 mm	120 mm	CTC-2667891	135.35
2667972		Bushing		85 mm		CTC-0964402	27.84
2667972		P-UB-10		85 mm	120 mm	CTC-2668011	135.35



REPLACEMENT KITS FOR CATERPILLAR® EQUIPMENT

Excavators							
APPLICATION	CYL #	Misc-Parts, Instructions, etc.	CODE	ROD	BORE	KIT #	List \$
MODEL 320D L							
BOOM							
FAL1-UP; KGF1-UP							
2426746		Bushing		85 mm		CTC-0964402	27.84
2426746		P-UB-10		85 mm	120 mm	CTC-2667891	135.35
JGZ1-UP; MDE1-UP							
2426746		Bushing		85 mm		CTC-0964402	27.84
2426746		P-UB-10		85 mm	120 mm	CTC-2667891	135.35
BUCKET							
A6F1-UP; A8F1-UP; A9F1-UP; CXY1-UP; DHK1-UP; FAL1-UP; JFZ1-UP; JGZ1-UP; KGF1-UP; MCH1-UP; MDE1-UP; MGG1-UP; PHX1-UP							
2426756		Bushing		85 mm		CTC-0964402	27.84
2426756		P-UB-10		85 mm	120 mm	CTC-2478888	115.90
A6F1-UP; A8F1-UP; A9F1-UP; CXY1-UP; DHK1-UP; FAL1-UP; KGF1-UP; MCH1-UP; PHX1-UP							
2254591		Bushing		95 mm		CTC-0964430	30.24
2254591		P-UB-10		95 mm	135 mm	CTC-2344587	113.49
CXY1-UP; DHK1-UP							
2667978		Bushing		85 mm		CTC-0964402	27.84
2667978		P-UB-10		85 mm	120 mm	CTC-2668057	115.90
CXY1-UP; DHK1-UP; FAL1-UP; JGZ1-UP; KGF1-UP; MDE1-UP							
2254599		Bushing		95 mm		CTC-0964430	30.24
2254599		P-UB-10		95 mm	135 mm	CTC-2590656	112.38
2426759		Bushing		85 mm		CTC-0964402	27.84
2426759		P-UB-10		85 mm	120 mm	CTC-2667892	115.90
STICK							
A6F1-UP; A8F1-UP; A9F1-UP; CXY1-UP; DHK1-UP; FAL1-UP; JFZ1-UP; JGZ1-UP; KGF1-UP; MCH1-UP; MDE1-UP; MGG1-UP; PHX1-UP							
2426744		Bushing		100 mm		CTC-0965625	41.45
2426744		P-UB-10		100 mm	140 mm	CTC-2478974	166.54
A6F1-UP; A8F1-UP; A9F1-UP; CXY1-UP; DHK1-UP; FAL1-UP; KGF1-UP; MCH1-UP; PHX1-UP							
2426734		Bushing		100 mm		CTC-0965625	41.45
2426734		P-UB-10		100 mm	140 mm	CTC-2478878	166.54
CXY1-UP; DHK1-UP							
2667974		Bushing		100 mm		CTC-0965625	41.45
2667974		P-UB-10		100 mm	140 mm	CTC-2668012	166.54
CXY1-UP; DHK1-UP; FAL1-UP; JGZ1-UP; KGF1-UP; MDE1-UP							
2426748		Bushing		100 mm		CTC-0965625	41.45
2426748		P-UB-10		100 mm	140 mm	CTC-2590775	166.54
2426763		Bushing		100 mm		CTC-0965625	41.45
2426763		P-UB-10		100 mm	140 mm	CTC-2590775	166.54
MODEL 320D LN							
BOOM							
WBN1-UP							
2426731		Bushing		85 mm		CTC-0964402	27.84
2426731		P-UB-10		85 mm	120 mm	CTC-2478868	135.35
2426746		Bushing		85 mm		CTC-0964402	27.84
2426746		P-UB-10		85 mm	120 mm	CTC-2667891	135.35
2667972		Bushing		85 mm		CTC-0964402	27.84
2667972		P-UB-10		85 mm	120 mm	CTC-2668011	135.35

CATERPILLAR®



REPLACEMENT KITS FOR CATERPILLAR® EQUIPMENT

Excavators							
APPLICATION	CYL #	Misc-Parts, Instructions, etc.	CODE	ROD	BORE	KIT #	List \$
MODEL 320D LN							
BUCKET							
WBN1-UP							
2426756		Bushing	85 mm			CTC-0964402	27.84
2426756		P-UB-10	85 mm	120 mm		CTC-2478888	115.90
2426759		Bushing	85 mm			CTC-0964402	27.84
2426759		P-UB-10	85 mm	120 mm		CTC-2667892	115.90
2667978		Bushing	85 mm			CTC-0964402	27.84
2667978		P-UB-10	85 mm	120 mm		CTC-2668057	115.90
STICK							
WBN1-UP							
2426734		Bushing	100 mm			CTC-0965625	41.45
2426734		P-UB-10	100 mm	140 mm		CTC-2478878	166.54
2426748		Bushing	100 mm			CTC-0965625	41.45
2426748		P-UB-10	100 mm	140 mm		CTC-2590775	166.54
2667974		Bushing	100 mm			CTC-0965625	41.45
2667974		P-UB-10	100 mm	140 mm		CTC-2668012	166.54
MODEL 320D LRR							
BOOM							
EBY1-UP							
2667972		Bushing	85 mm			CTC-0964402	27.84
2667972		P-UB-10	85 mm	120 mm		CTC-2668011	135.35
EBY1-UP; FXK1-UP; GKL1-UP; TAE1-UP; WFD1-UP; XCK1-UP; ZGB1-UP							
2426731		Bushing	85 mm			CTC-0964402	27.84
2426731		P-UB-10	85 mm	120 mm		CTC-2478868	135.35
EBY1-UP; GKL1-UP; TAE1-UP							
2426746		Bushing	85 mm			CTC-0964402	27.84
2426746		P-UB-10	85 mm	120 mm		CTC-2667891	135.35
BUCKET							
EBY1-UP							
2667978		Bushing	85 mm			CTC-0964402	27.84
2667978		P-UB-10	85 mm	120 mm		CTC-2668057	115.90
EBY1-UP; FXK1-UP; GKL1-UP; TAE1-UP							
2426759		Bushing	85 mm			CTC-0964402	27.84
2426759		P-UB-10	85 mm	120 mm		CTC-2667892	115.90
EBY1-UP; FXK1-UP; GKL1-UP; TAE1-UP; WFD1-UP; XCK1-UP; ZGB1-UP							
2426756		Bushing	85 mm			CTC-0964402	27.84
2426756		P-UB-10	85 mm	120 mm		CTC-2478888	115.90
STICK							
EBY1-UP							
2667974		Bushing	100 mm			CTC-0965625	41.45
2667974		P-UB-10	100 mm	140 mm		CTC-2668012	166.54
EBY1-UP; FXK1-UP; GKL1-UP; TAE1-UP; WFD1-UP; XCK1-UP							
2426744		Bushing	100 mm			CTC-0965625	41.45
2426744		P-UB-10	100 mm	140 mm		CTC-2478974	166.54
EBY1-UP; FXK1-UP; GKL1-UP; TAE1-UP; WFD1-UP; XCK1-UP; ZGB1-UP							
2426734		Bushing	100 mm			CTC-0965625	41.45
2426734		P-UB-10	100 mm	140 mm		CTC-2478878	166.54



REPLACEMENT KITS FOR CATERPILLAR® EQUIPMENT

Excavators							
APPLICATION	CYL #	Misc-Parts, Instructions, etc.	CODE	ROD	BORE	KIT #	List \$
MODEL 320D LRR							
STICK							
EBY1-UP; GKL1-UP; TAE1-UP							
2426748		Bushing	100 mm			CTC-0965625	41.45
2426748		P-UB-10	100 mm	140 mm		CTC-2590775	166.54
MODEL 320D RR							
BOOM							
EBY1-UP							
2667972		Bushing	85 mm			CTC-0964402	27.84
2667972		P-UB-10	85 mm	120 mm		CTC-2668011	135.35
EBY1-UP; FXK1-UP; GKL1-UP; WFD1-UP; XCK1-UP; YDS1-UP							
2426731		Bushing	85 mm			CTC-0964402	27.84
2426731		P-UB-10	85 mm	120 mm		CTC-2478868	135.35
EBY1-UP; GKL1-UP; YDS1-UP							
2426746		Bushing	85 mm			CTC-0964402	27.84
2426746		P-UB-10	85 mm	120 mm		CTC-2667891	135.35
BUCKET							
EBY1-UP							
2667978		Bushing	85 mm			CTC-0964402	27.84
2667978		P-UB-10	85 mm	120 mm		CTC-2668057	115.90
EBY1-UP; FXK1-UP; GKL1-UP; WFD1-UP; XCK1-UP; YDS1-UP							
2426756		Bushing	85 mm			CTC-0964402	27.84
2426756		P-UB-10	85 mm	120 mm		CTC-2478888	115.90
EBY1-UP; FXK1-UP; GKL1-UP; YDS1-UP							
2426759		Bushing	85 mm			CTC-0964402	27.84
2426759		P-UB-10	85 mm	120 mm		CTC-2667892	115.90
STICK							
EBY1-UP							
2667974		Bushing	100 mm			CTC-0965625	41.45
2667974		P-UB-10	100 mm	140 mm		CTC-2668012	166.54
EBY1-UP; FXK1-UP; GKL1-UP; WFD1-UP; XCK1-UP; YDS1-UP							
2426734		Bushing	100 mm			CTC-0965625	41.45
2426734		P-UB-10	100 mm	140 mm		CTC-2478878	166.54
2426744		Bushing	100 mm			CTC-0965625	41.45
2426744		P-UB-10	100 mm	140 mm		CTC-2478974	166.54
EBY1-UP; GKL1-UP; YDS1-UP							
2426748		Bushing	100 mm			CTC-0965625	41.45
2426748		P-UB-10	100 mm	140 mm		CTC-2590775	166.54
MODEL 320L							
BOOM							
874898		P-UB-10	85 mm	120 mm		CTC-1764934	196.72
BUCKET							
1251547		P-UB-10	65 mm	100 mm		CTC-418914	172.89
417652		P-UB-10	65 mm	100 mm		CTC-417664	172.96
418840		P-UB-10	65 mm	100 mm		CTC-418914	172.89
717291		P-UB-10	85 mm	130 mm		CTC-7Y5145	226.08
7Y5100		P-UB-10	85 mm	130 mm		CTC-7Y5145	226.08

CATERPILLAR®



REPLACEMENT KITS FOR CATERPILLAR® EQUIPMENT

Excavators							
APPLICATION	CYL #	Misc-Parts, Instructions, etc.	CODE	ROD	BORE	KIT #	List \$
MODEL 320L							
STICK							
	7Y4650		P-UB-10	105 mm	150 mm	CTC-1163612	255.25
	875493		P-UB-10	100 mm	140 mm	CTC-1270630	287.74
MODEL 320N							
BOOM							
	874898		P-UB-10	85 mm	120 mm	CTC-1764934	196.72
BUCKET							
	7Y5100		P-UB-10	85 mm	130 mm	CTC-7Y5145	226.08
STICK							
	875493		P-UB-10	100 mm	140 mm	CTC-1270630	287.74
MODEL 320S							
BOOM							
	0875496		P-UB-10	85 mm	120 mm	CTC-1184131	211.36
	1069596		P-UB-10	95 mm	160 mm	CTC-6C6091	284.91
BOOM VA							
	6C6085		P-UB-10	95 mm	160 mm	CTC-6C6091	284.91
BUCKET							
	0875633		P-UB-10	85 mm	120 mm	CTC-1184131	211.36
	7Y5100		P-UB-10	85 mm	130 mm	CTC-7Y5145	226.08
STICK							
	0875422		P-UB-10	100 mm	140 mm	CTC-0875387	289.01
	0876638		P-UB-10	100 mm	140 mm	CTC-0875387	289.01
MODEL 321B							
BUCKET							
	1232084		P-UB-10	90 mm	130 mm	CTC-1373768	372.60
UNSPECIFIED APPLICATION							
	1183967		P-UB-10	85 mm	120 mm	CTC-1261947	292.79
MODEL 322							
BOOM							
	1052571		P-UB-10	90 mm	130 mm	CTC-1052585	409.47
	1052588		P-UB-10	100 mm	140 mm	CTC-1270630	287.74
	711345		P-UB-10	90 mm	130 mm	CTC-711360	250.92
BUCKET							
	0875633		P-UB-10	85 mm	120 mm	CTC-0875394	218.89
	0875633		P-UB-10	85 mm	120 mm	CTC-1184131	211.36
	1052597		P-UB-10	85 mm	130 mm	CTC-1052601	366.59
	1185931		P-UB-10	85 mm	120 mm	CTC-1186023	225.29
	418840		P-UB-10	65 mm	100 mm	CTC-418914	172.89
	717291		P-UB-10	85 mm	130 mm	CTC-7Y5145	226.08
	7Y5100		P-UB-10	85 mm	130 mm	CTC-7Y5145	226.08
	7Y5150		P-UB-10	105 mm	150 mm	CTC-1163612	255.25
STICK							
	717341		P-UB-10	100 mm	140 mm	CTC-0875387	289.01



REPLACEMENT KITS FOR CATERPILLAR® EQUIPMENT

Excavators							
APPLICATION	CYL #	Misc-Parts, Instructions, etc.	CODE	ROD	BORE	KIT #	List \$
MODEL 322B, 322BL							
BOOM							
	1140636		P-UB-10	100 mm	140 mm	CTC-1184024	275.32
	1184069		P-UB-10	90 mm	130 mm	CTC-1373765	402.63
	1184070		P-UB-10	100 mm	140 mm	CTC-1373764	272.99
	1184166		P-UB-10	90 mm	130 mm	CTC-1184175	249.77
	1336869		P-UB-10	90 mm	130 mm	CTC-1540748	243.70
BUCKET							
	1183921		P-UB-10	105 mm	150 mm	CTC-1163612	255.25
	1183921		P-UB-10	105 mm	150 mm	CTC-1680758	295.22
	1184008		P-UB-10	90 mm	130 mm	CTC-1184175	249.77
	1184134		P-UB-10	85 mm	120 mm	CTC-1184131	211.36
	1232044		P-UB-10	90 mm	130 mm	CTC-1184175	249.77
	1232084		P-UB-10	90 mm	130 mm	CTC-1373768	372.60
	1232091		P-UB-10	90 mm	130 mm	CTC-1261887	361.78
	1251547		P-UB-10	65 mm	100 mm	CTC-418914	172.89
	1336810		P-UB-10	105 mm	150 mm	CTC-1289277	311.24
	1346987		P-UB-10	65 mm	100 mm	CTC-1764935	187.18
	1540756		P-UB-10	90 mm	130 mm	CTC-1540757	379.28
	411726		P-UB-10	110 mm	160 mm	CTC-0876654	271.50
	418840		P-UB-10	65 mm	100 mm	CTC-418914	172.89
STICK							
	1163638		P-UB-10	110 mm	170 mm	CTC-1680759	338.96
	1183953		P-UB-10	100 mm	140 mm	CTC-1373764	272.99
	1184000		P-UB-10	105 mm	150 mm	CTC-1163612	255.25
	1184000		P-UB-10	105 mm	150 mm	CTC-1680758	295.22
	1184176		P-UB-10	100 mm	140 mm	CTC-1184024	275.32
	1336771		P-UB-10	105 mm	150 mm	CTC-1373767	354.28
	7Y4650		P-UB-10	105 mm	150 mm	CTC-7Y4698	284.41
TILT CAB							
	N/A		P-UB-10	2-1/4	5	CTC-9X6392	135.36
UNSPECIFIED APPLICATION							
	1183967		P-UB-10	85 mm	120 mm	CTC-1261947	292.79
	1540743		P-UB-10	85 mm	120 mm	CTC-1540744	396.77
	1540747		P-UB-10	90 mm	130 mm	CTC-1540748	243.70
MODEL 322C							
BOOM							
BFK1-UP; BGR1-UP							
	1772440		Bushing	90 mm		CTC-1140758	34.28
	1772440		P-UB-10	90 mm	130 mm	CTC-2159986	105.79
	6C9407		Bushing	100 mm		CTC-1140757	41.78
	6C9407		P-UB-10	100 mm	170 mm	CTC-2330763	190.11

CATERPILLAR®



REPLACEMENT KITS FOR CATERPILLAR® EQUIPMENT

Excavators

APPLICATION	CYL #	Misc-Parts, Instructions, etc.	CODE	ROD	BORE	KIT #	List \$
MODEL 322C							
BOOM							
BKM1-UP; BLP1-UP							
1772440			Bushing	90 mm		CTC-1140758	34.28
1772440			P-UB-10	90 mm	130 mm	CTC-2159986	105.79
1915580			Bushing	90 mm		CTC-1052575	26.85
1915580			P-UB-10	90 mm	130 mm	CTC-2590625	135.18
2043619			Bushing	90 mm		CTC-1052575	26.85
2043619			P-UB-10	90 mm	130 mm	CTC-2590628	135.18
2590711			Bushing	90 mm		CTC-1052575	26.85
2590711			P-UB-10	90 mm	130 mm	CTC-2590712	136.60
2897878			Bushing	90 mm		CTC-1140758	34.28
2897878			P-UB-10	90 mm	130 mm	CTC-2897878K	135.64
BPH1-UP; CAM1-UP; LAR1-UP; MZH1-UP							
1772440			Bushing	90 mm		CTC-1140758	34.28
1772440			P-UB-10	90 mm	130 mm	CTC-1799772	174.88
2044910			Bushing	90 mm		CTC-1140758	34.28
2044910			P-UB-10	90 mm	130 mm	CTC-2044910K	116.32
2044912			Bushing	100 mm		CTC-1140757	41.78
2044912			P-UB-10	100 mm	140 mm	CTC-2044912K	149.07
C3R1-UP; CBY1-UP							
1756855			Bushing	100 mm		CTC-1140757	41.78
1756855			P-UB-10	100 mm	140 mm	CTC-1756855K	150.28
DAA1-UP; FED1-UP							
2742525			Bushing	90 mm		CTC-1140758	34.28
BUCKET							
BFK1-UP; BGR1-UP; BKM1-UP; BLP1-UP							
1772446			Bushing	90 mm		CTC-1140758	34.28
1772446			P-UB-10	90 mm	130 mm	CTC-2159986	105.79
1772465			Bushing	105 mm		CTC-1140760	45.53
1772465			P-UB-10	105 mm	150 mm	CTC-1915619	137.21
2478853			Bushing	105 mm		CTC-1140760	45.53
2478853			P-UB-10	105 mm	150 mm	CTC-1915619	137.21
BKM1-UP							
1346987			Bushing	65 mm		CTC-1140754	20.58
1346987			P-UB-10	65 mm	100 mm	CTC-1764935	187.18
2043689			Bushing	85 mm		CTC-0964402	27.84
2043689			P-UB-10	85 mm	120 mm	CTC-2479001	125.36



REPLACEMENT KITS FOR CATERPILLAR® EQUIPMENT

Excavators							
APPLICATION	CYL #	Misc-Parts, Instructions, etc.	CODE	ROD	BORE	KIT #	List \$
MODEL 322C							
BUCKET							
BKM1-UP; BLP1-UP							
1772453		Bushing		90 mm		CTC-1052575	26.85
1772453		P-UB-10		90 mm	130 mm	CTC-1261887	361.78
1850346		Bushing		85 mm		CTC-0964402	27.84
1850346		P-UB-10		85 mm	120 mm	CTC-1540744	396.77
1915584		Bushing		90 mm		CTC-1052575	26.85
1915584		P-UB-10		90 mm	130 mm	CTC-2590626	118.68
2043621		Bushing		90 mm		CTC-1052575	26.85
2043621		P-UB-10		90 mm	130 mm	CTC-2590627	118.68
2043696		Bushing		85 mm		CTC-0964402	27.84
2043696		P-UB-10		85 mm	120 mm	CTC-2479000	125.36
2590705		Bushing		85 mm		CTC-0964402	27.84
2590705		P-UB-10		85 mm	120 mm	CTC-2590706	125.36
2590718		Bushing		90 mm		CTC-1052575	26.85
2590718		P-UB-10		90 mm	130 mm	CTC-2590719	120.10
2590746		Bushing		105 mm		CTC-1140760	45.53
2590746		P-UB-10		105 mm	150 mm	CTC-2590743	105.92
2897887		Bushing		90 mm		CTC-1140758	34.28
2897887		P-UB-10		90 mm	130 mm	CTC-2159986	105.79
BKM243-UP; BLP180-UP							
2043617		Bushing		85 mm		CTC-0964402	27.84
2043617		P-UB-10		85 mm	120 mm	CTC-2043627	118.30
BPH1-UP; CAM1-UP; LAR1-UP; MZH1-UP							
2044914		Bushing		90 mm		CTC-1140758	34.28
2044914		P-UB-10		90 mm	130 mm	CTC-2044914K	96.03
C3R1-296; CBY1-UP							
1232044		Bushing		90 mm		CTC-1140758	34.28
1232044		P-UB-10		90 mm	130 mm	CTC-1764914	120.02
C3R297-UP							
1799764		Bushing		90 mm		CTC-1140758	34.28
1799764		P-UB-10		90 mm	130 mm	CTC-1799764K	105.79
DAA1-UP; FED1-UP							
2742521		Bushing		85 mm		CTC-1140756	29.72
2742521		P-UB-10		85 mm	120 mm	CTC-2742511	99.56
2742532		Bushing		90 mm		CTC-1140758	34.28
CAB TILT							
BPH1-UP; C3R1001-UP; CAM1-UP; LAR1001-UP; LAR1-UP; MZH1-UP							
1175148		P-UB-10		2-1/4	5	CTC-2417578	53.84
2632914		P-UB-10		2-1/4	5	CTC-2417578	53.84
GRAPPLE							
CBY1-UP							
1504569		P-UB-10		2-1/2	4	CTC-1533724	180.99
1504569					2-5/8	CTC-8T0785	27.35
STICK							
BFK1-UP; BGR1-UP; BKM1-UP; BLP1-UP							
1772443		Bushing		100 mm		CTC-1140757	41.78
1772443		P-UB-10		100 mm	140 mm	CTC-2159985	103.63

CATERPILLAR®



REPLACEMENT KITS FOR CATERPILLAR® EQUIPMENT

Excavators							
APPLICATION	CYL #	Misc-Parts, Instructions, etc.	CODE	ROD	BORE	KIT #	List \$
MODEL 322C							
STICK							
BKM1-UP							
1169123		Bushing		105 mm		CTC-1140760	45.53
1169123		P-UB-10		105 mm	150 mm	CTC-1997416	174.43
BKM1-UP; BLP1-UP							
1915582		Bushing		100 mm		CTC-0965625	41.45
1915582		P-UB-10		100 mm	140 mm	CTC-2590631	130.38
2043620		Bushing		100 mm		CTC-0965625	41.45
2043620		P-UB-10		100 mm	140 mm	CTC-2590633	130.38
2590715		Bushing		100 mm		CTC-0965625	41.45
2590715		P-UB-10		100 mm	140 mm	CTC-2590699	130.38
BPH1-UP; CAM1-UP; LAR1-UP; MZH1-UP							
1772443		Bushing		100 mm		CTC-1140757	41.78
1772443		P-UB-10		100 mm	140 mm	CTC-1589093	103.63
C3R1-UP; CBY1-UP							
1336771		Bushing		105 mm		CTC-0995572	35.65
1336771		P-UB-10		105 mm	150 mm	CTC-1373767	354.28
1433201		Bushing		110 mm		CTC-1140761	72.39
1433201		P-UB-10		110 mm	170 mm	CTC-1433201K	203.34
CBY1-UP							
1163638		Bushing		110 mm		CTC-1140761	72.39
1163638		P-UB-10		110 mm	170 mm	CTC-1680759	338.96
DAA1-UP; FED1-UP							
2742529		Bushing		100 mm		CTC-1140757	41.78
2742529		P-UB-10		100 mm	140 mm	CTC-2742515	143.27
2897884		Bushing		100 mm		CTC-1140757	41.78
2897884		P-UB-10		100 mm	140 mm	CTC-2478792	156.74
MODEL 322C FM LGP							
BOOM							
BYL1-UP							
1756855		Bushing		100 mm		CTC-1140757	41.78
1756855		P-UB-10		100 mm	140 mm	CTC-1756855K	150.28
1772440		Bushing		90 mm		CTC-1140758	34.28
1772440		P-UB-10		90 mm	130 mm	CTC-1799772	174.88
BUCKET							
BYL1-UP							
1799764		Bushing		90 mm		CTC-1140758	34.28
1799764		P-UB-10		90 mm	130 mm	CTC-1799764K	105.79
CAB TILT							
BYL1001-UP							
2632914	O-ring kit. 2 per application.	O-ring Kit				CTC-1143616	5.19
2632914		P-UB-10		2-1/4	5	CTC-2417578	53.84
BYL1-UP							
1175148	O-ring kit. 2 per application.	O-ring Kit				CTC-1143616	5.19
1175148		P-UB-10		2-1/4	5	CTC-2417578	53.84



REPLACEMENT KITS FOR CATERPILLAR® EQUIPMENT

Excavators							
APPLICATION	CYL #	Misc-Parts, Instructions, etc.	CODE	ROD	BORE	KIT #	List \$
MODEL 322C FM LGP							
STICK							
BYL1-UP							
1336771		Bushing	105 mm			CTC-0995572	35.65
1336771		P-UB-10	105 mm	150 mm		CTC-1373767	354.28
1913118		Bushing	110 mm			CTC-1140761	72.39
1913118		P-UB-10	110 mm	170 mm		CTC-1913171	203.34
MODEL 322C L							
BOOM							
BKJ1-UP							
1772440		Bushing	90 mm			CTC-1140758	34.28
1772440		P-UB-10	90 mm	130 mm		CTC-1799772	174.88
2044910		Bushing	90 mm			CTC-1140758	34.28
2044910		P-UB-10	90 mm	130 mm		CTC-2044910K	116.32
2044912		Bushing	100 mm			CTC-1140757	41.78
2044912		P-UB-10	100 mm	140 mm		CTC-2044912K	149.07
BKM1-UP; BLP1-UP							
1772440		Bushing	90 mm			CTC-1140758	34.28
1772440		P-UB-10	90 mm	130 mm		CTC-2159986	105.79
1915580		Bushing	90 mm			CTC-1052575	26.85
1915580		P-UB-10	90 mm	130 mm		CTC-2590625	135.18
2043619		Bushing	90 mm			CTC-1052575	26.85
2043619		P-UB-10	90 mm	130 mm		CTC-2590628	135.18
2590711		Bushing	90 mm			CTC-1052575	26.85
2590711		P-UB-10	90 mm	130 mm		CTC-2590712	136.60
2897878		Bushing	90 mm			CTC-1140758	34.28
2897878		P-UB-10	90 mm	130 mm		CTC-2897878K	135.64
DAA1-UP; FED1-UP							
2742525		Bushing	90 mm			CTC-1140758	34.28
EMR1-UP; MAR1-UP							
1772440		Bushing	90 mm			CTC-1140758	34.28
1772440		P-UB-10	90 mm	130 mm		CTC-2159986	105.79
2113069		Bushing	100 mm			CTC-1140757	41.78
2113069		P-UB-10	100 mm	170 mm		CTC-2519341	223.79
BUCKET							
BKJ1-UP							
1589061		Bushing	85 mm			CTC-1140756	29.72
1589061		P-U-10	85 mm	120 mm		CTC-2366389	86.07
2044914		Bushing	90 mm			CTC-1140758	34.28
2044914		P-UB-10	90 mm	130 mm		CTC-2044914K	96.03
BKJ1-UP; BKM1-UP							
1346987		Bushing	65 mm			CTC-1140754	20.58
1346987		P-UB-10	65 mm	100 mm		CTC-1764935	187.18
BKJ1-UP; BKM1-UP; BLP1-UP; EMR1-UP; MAR1-UP							
1772446		Bushing	90 mm			CTC-1140758	34.28
1772446		P-UB-10	90 mm	130 mm		CTC-2159986	105.79
1772465		Bushing	105 mm			CTC-1140760	45.53
1772465		P-UB-10	105 mm	150 mm		CTC-1915619	137.21

CATERPILLAR®



REPLACEMENT KITS FOR CATERPILLAR® EQUIPMENT

Excavators							
APPLICATION	CYL #	Misc-Parts, Instructions, etc.	CODE	ROD	BORE	KIT #	List \$
MODEL 322C L							
BUCKET							
BKM1-UP							
2043689		Bushing	85 mm			CTC-0964402	27.84
2043689		P-UB-10	85 mm	120 mm		CTC-2479001	125.36
BKM1-UP; BLP1-UP							
1772453		Bushing	90 mm			CTC-1052575	26.85
1772453		P-UB-10	90 mm	130 mm		CTC-1261887	361.78
1850346		Bushing	85 mm			CTC-0964402	27.84
1850346		P-UB-10	85 mm	120 mm		CTC-1540744	396.77
1915584		Bushing	90 mm			CTC-1052575	26.85
1915584		P-UB-10	90 mm	130 mm		CTC-2590626	118.68
2043621		Bushing	90 mm			CTC-1052575	26.85
2043621		P-UB-10	90 mm	130 mm		CTC-2590627	118.68
2043696		Bushing	85 mm			CTC-0964402	27.84
2043696		P-UB-10	85 mm	120 mm		CTC-2479000	125.36
2590705		Bushing	85 mm			CTC-0964402	27.84
2590705		P-UB-10	85 mm	120 mm		CTC-2590706	125.36
2590718		Bushing	90 mm			CTC-1052575	26.85
2590718		P-UB-10	90 mm	130 mm		CTC-2590719	120.10
2590746		Bushing	105 mm			CTC-1140760	45.53
2590746		P-UB-10	105 mm	150 mm		CTC-2590743	105.92
2897887		Bushing	90 mm			CTC-1140758	34.28
2897887		P-UB-10	90 mm	130 mm		CTC-2159986	105.79
BKM1-UP; BLP1-UP; EMR1-UP; MAR1-UP							
2478853		Bushing	105 mm			CTC-1140760	45.53
2478853		P-UB-10	105 mm	150 mm		CTC-1915619	137.21
BKM243-UP; BLP180-UP							
2043617		Bushing	85 mm			CTC-0964402	27.84
2043617		P-UB-10	85 mm	120 mm		CTC-2043627	118.30
DAA1-UP; FED1-UP							
2742521		Bushing	85 mm			CTC-1140756	29.72
2742521		P-UB-10	85 mm	120 mm		CTC-2742511	99.56
2742532		Bushing	90 mm			CTC-1140758	34.28
HEK1-UP							
1709808		Bushing	65 mm			CTC-1140754	20.58
1709808		P-UB-10	65 mm	100 mm		CTC-1709941	109.74
STICK							
BKJ1-UP							
1169123		Bushing	105 mm			CTC-1140760	45.53
1169123		P-UB-10	105 mm	150 mm		CTC-1169123K	159.26
1772443		Bushing	100 mm			CTC-1140757	41.78
1772443		P-UB-10	100 mm	140 mm		CTC-1589093	103.63
BKM1-UP							
1169123		Bushing	105 mm			CTC-1140760	45.53
1169123		P-UB-10	105 mm	150 mm		CTC-1997416	174.43



REPLACEMENT KITS FOR CATERPILLAR® EQUIPMENT

Excavators							
APPLICATION	CYL #	Misc-Parts, Instructions, etc.	CODE	ROD	BORE	KIT #	List \$
MODEL 322C L							
STICK							
BKM1-UP; BLP1-UP							
1915582		Bushing	100 mm			CTC-0965625	41.45
1915582		P-UB-10	100 mm	140 mm		CTC-2590631	130.38
2043620		Bushing	100 mm			CTC-0965625	41.45
2043620		P-UB-10	100 mm	140 mm		CTC-2590633	130.38
2590715		Bushing	100 mm			CTC-0965625	41.45
2590715		P-UB-10	100 mm	140 mm		CTC-2590699	130.38
BKM1-UP; BLP1-UP; EMR1-UP; MAR1-UP							
1772443		Bushing	100 mm			CTC-1140757	41.78
1772443		P-UB-10	100 mm	140 mm		CTC-2159985	103.63
DAA1-UP; EMR1-UP; FED1-UP; MAR1-UP							
2897884		Bushing	100 mm			CTC-1140757	41.78
2897884		P-UB-10	100 mm	140 mm		CTC-2478792	156.74
DAA1-UP; FED1-UP							
2742529		Bushing	100 mm			CTC-1140757	41.78
2742529		P-UB-10	100 mm	140 mm		CTC-2742515	143.27
HEK1-UP							
2166607		Bushing	105 mm			CTC-1140760	45.53
2166607		P-UB-10	105 mm	150 mm		CTC-1915619	137.21
MODEL 322C LN							
BOOM							
BFK1-UP; BGR1-UP							
6C9407		Bushing	100 mm			CTC-1140757	41.78
6C9407		P-UB-10	100 mm	170 mm		CTC-2330763	190.11
BFK1-UP; BGR1-UP; EMR1-UP; MAR1-UP							
1772440		Bushing	90 mm			CTC-1140758	34.28
1772440		P-UB-10	90 mm	130 mm		CTC-2159986	105.79
EMR1-UP; MAR1-UP							
2113069		Bushing	100 mm			CTC-1140757	41.78
2113069		P-UB-10	100 mm	170 mm		CTC-2519341	223.79
BUCKET							
BFK1-UP; BGR1-UP; EMR1-UP; MAR1-UP							
1772446		Bushing	90 mm			CTC-1140758	34.28
1772446		P-UB-10	90 mm	130 mm		CTC-2159986	105.79
1772465		Bushing	105 mm			CTC-1140760	45.53
1772465		P-UB-10	105 mm	150 mm		CTC-1915619	137.21
2478853		Bushing	105 mm			CTC-1140760	45.53
2478853		P-UB-10	105 mm	150 mm		CTC-1915619	137.21
STICK							
BFK1-UP; BGR1-UP; EMR1-UP; MAR1-UP							
1772443		Bushing	100 mm			CTC-1140757	41.78
1772443		P-UB-10	100 mm	140 mm		CTC-2159985	103.63
EMR1-UP; MAR1-UP							
2897884		Bushing	100 mm			CTC-1140757	41.78
2897884		P-UB-10	100 mm	140 mm		CTC-2478792	156.74

CATERPILLAR®



REPLACEMENT KITS FOR CATERPILLAR® EQUIPMENT

Excavators							
APPLICATION	CYL #	Misc-Parts, Instructions, etc.	CODE	ROD	BORE	KIT #	List \$
MODEL 322L							
BOOM							
	1052571		P-UB-10	90 mm	130 mm	CTC-1052585	409.47
	1052588		P-UB-10	100 mm	140 mm	CTC-1270630	287.74
	711345		P-UB-10	90 mm	130 mm	CTC-711360	250.92
BUCKET							
	1052597		P-UB-10	85 mm	130 mm	CTC-1052601	366.59
	717291		P-UB-10	85 mm	130 mm	CTC-7Y5145	226.08
	7Y5100		P-UB-10	85 mm	130 mm	CTC-7Y5145	226.08
	7Y5150		P-UB-10	105 mm	150 mm	CTC-1163612	255.25
	875633		P-UB-10	85 mm	120 mm	CTC-0875394	218.89
STICK							
	717341		P-UB-10	100 mm	140 mm	CTC-0875387	289.01
MODEL 322N							
BOOM							
	711345		P-UB-10	90 mm	130 mm	CTC-711360	250.92
BUCKET							
	717291		P-UB-10	85 mm	130 mm	CTC-7Y5145	226.08
	7Y5100		P-UB-10	85 mm	130 mm	CTC-7Y5145	226.08
	7Y5150		P-UB-10	105 mm	150 mm	CTC-1163612	255.25
STICK							
	717341		P-UB-10	100 mm	140 mm	CTC-0875387	289.01
MODEL 325							
BOOM							
	7Y4601		P-UB-10	95 mm	130 mm	CTC-7Y5147	252.83
BUCKET							
	0875491		P-UB-10	85 mm	120 mm	CTC-413665	264.78
	0875633		P-UB-10	85 mm	120 mm	CTC-0875394	218.89
	0875633		P-UB-10	85 mm	120 mm	CTC-1184131	211.36
	1072614		P-UB-10	85 mm	130 mm	CTC-7Y5145	226.08
	1346987		P-UB-10	65 mm	100 mm	CTC-1764935	187.18
	417652		P-UB-10	65 mm	100 mm	CTC-417664	172.96
	418840		P-UB-10	65 mm	100 mm	CTC-418914	172.89
	717291		P-UB-10	85 mm	130 mm	CTC-7Y5145	226.08
	7Y5100		P-UB-10	85 mm	130 mm	CTC-7Y5145	226.08
	7Y5150		P-UB-10	105 mm	150 mm	CTC-1163612	255.25
STICK							
	7Y4650		P-UB-10	105 mm	150 mm	CTC-1163612	255.25
	7Y4926		P-UB-10	110 mm	170 mm	CTC-1163649	318.56
MODEL 325B, 325BL							
BOOM							
	1077040		P-UB-10	100 mm	140 mm	CTC-1373766	262.06
	1140636		P-UB-10	100 mm	140 mm	CTC-1184024	275.32
	1169123		P-UB-10	105 mm	150 mm	CTC-1163612	255.25
	1232081		P-UB-10	105 mm	150 mm	CTC-1373767	354.28
	1540760		P-UB-10	100 mm	140 mm	CTC-1540761	323.35



REPLACEMENT KITS FOR CATERPILLAR® EQUIPMENT

Excavators							
APPLICATION	CYL #	Misc-Parts, Instructions, etc.	CODE	ROD	BORE	KIT #	List \$
MODEL 325B, 325BL							
BUCKET							
	1183921		P-UB-10	105 mm	150 mm	CTC-1163612	255.25
	1183921		P-UB-10	105 mm	150 mm	CTC-1680758	295.22
	1184134		P-UB-10	85 mm	120 mm	CTC-1184131	211.36
	1232044		P-UB-10	90 mm	130 mm	CTC-1184175	249.77
	1232084		P-UB-10	90 mm	130 mm	CTC-1373768	372.60
	1336810		P-UB-10	105 mm	150 mm	CTC-1289277	311.24
	1497610		P-UB-10	90 mm	130 mm	CTC-1184175	249.77
	1540756		P-UB-10	90 mm	130 mm	CTC-1540757	379.28
	1540772		P-UB-10	90 mm	130 mm	CTC-1540773	379.03
	411726		P-UB-10	110 mm	160 mm	CTC-0876654	271.50
	417652		P-UB-10	65 mm	100 mm	CTC-417664	172.96
	418840		P-UB-10	65 mm	100 mm	CTC-418914	172.89
STICK							
	0875375		P-UB-10	130 mm	180 mm	CTC-0875407	336.78
	1163638		P-UB-10	110 mm	170 mm	CTC-1680759	338.96
	1184000		P-UB-10	105 mm	150 mm	CTC-1163612	255.25
	1184000		P-UB-10	105 mm	150 mm	CTC-1680758	295.22
	1232081		P-UB-10	105 mm	150 mm	CTC-1373767	354.28
	1479427		P-UB-10	105 mm	150 mm	CTC-1680758	295.22
	1540765		P-UB-10	105 mm	150 mm	CTC-1540766	331.97
	7Y4650		P-UB-10	105 mm	150 mm	CTC-7Y4698	284.41
MODEL 325C							
BOOM							
AMH1-UP; BKW1-UP; BMM1-UP; BTD1-UP							
	2096006		Bushing	100 mm		CTC-0965625	41.45
	2096006		P-UB-10	100 mm	140 mm	CTC-2590634	127.95
BKW1-UP; BMM1-UP							
	1799789		Bushing	100 mm		CTC-0965625	41.45
	1799789		P-UB-10	100 mm	140 mm	CTC-1336823	271.64
	1915587		Bushing	100 mm		CTC-0965625	41.45
	1915587		P-UB-10	100 mm	140 mm	CTC-2590632	127.95
	2590724		Bushing	100 mm		CTC-0965625	41.45
	2590724		P-UB-10	100 mm	140 mm	CTC-2590725	127.95
JLC1-UP							
	2033906		Bushing	105 mm		CTC-1140760	45.53
	2033906		P-UB-10	105 mm	150 mm	CTC-1915619	137.21
JLC1-UP; JLD1-UP							
	1799782		Bushing	100 mm		CTC-1140757	41.78
	1799782		P-UB-10	100 mm	140 mm	CTC-2159985	103.63
	1915548		Bushing	105 mm		CTC-1140760	45.53
	1915548		P-UB-10	105 mm	150 mm	CTC-1915619	137.21
	2113069		Bushing	100 mm		CTC-1140757	41.78
	2113069		P-UB-10	100 mm	170 mm	CTC-2519341	223.79
	2502419		Bushing	105 mm		CTC-1140760	45.53
	2502419		P-UB-10	105 mm	150 mm	CTC-2426840	148.46

CATERPILLAR®



REPLACEMENT KITS FOR CATERPILLAR® EQUIPMENT

Excavators							
APPLICATION	CYL #	Misc-Parts, Instructions, etc.	CODE	ROD	BORE	KIT #	List \$
MODEL 325C							
BUCKET							
AMH1-UP; BKW1-UP; BMM1-UP; BTD1-UP							
2096011		Bushing		90 mm		CTC-1052575	26.85
2096011		P-UB-10		90 mm	130 mm	CTC-2590627	118.68
AMH1-UP; BTD1-UP; JLC1-UP; JLD1-UP							
1772465		Bushing		105 mm		CTC-1140760	45.53
1772465		P-UB-10		105 mm	150 mm	CTC-1915619	137.21
2478853		Bushing		105 mm		CTC-1140760	45.53
2478853		P-UB-10		105 mm	150 mm	CTC-1915619	137.21
BKW1-UP; BMM1-UP							
1799793		Bushing		90 mm		CTC-1052575	26.85
1799793		P-UB-10		90 mm	130 mm	CTC-2590626	118.68
1948276		Bushing		105 mm		CTC-1140760	45.53
1948276		P-UB-10		105 mm	150 mm	CTC-2003315	137.21
2478854		Bushing		105 mm		CTC-1140760	45.53
2478854		P-UB-10		105 mm	150 mm	CTC-2502475	115.12
2590732		Bushing		90 mm		CTC-1052575	26.85
2590732		P-UB-10		90 mm	130 mm	CTC-2590719	120.10
JLC1-UP							
2201532		Bushing		100 mm		CTC-1140757	41.78
2201532		P-UB-10		100 mm	140 mm	CTC-2159985	103.63
JLC1-UP; JLD1-UP							
1799764		Bushing		90 mm		CTC-1140758	34.28
1799764		P-UB-10		90 mm	130 mm	CTC-2159986	105.79
STICK							
AMH1-UP; BKW1-UP; BMM1-UP; BTD1-UP							
1799791		Bushing		105 mm		CTC-0995572	35.65
1799791		P-UB-10		105 mm	150 mm	CTC-1799791K	287.56
2096008		Bushing		105 mm		CTC-0995572	35.65
2096008		P-UB-10		105 mm	150 mm	CTC-2590637	291.00
BKW1-UP; BMM1-UP							
1915589		Bushing		105 mm		CTC-0995572	35.65
1915589		P-UB-10		105 mm	150 mm	CTC-2590636	291.00
2590728		Bushing		105 mm		CTC-0995572	35.65
2590728		P-UB-10		105 mm	150 mm	CTC-2590729	291.00
JLC1-UP							
2044907		P-UB-10		95 mm	160 mm	CTC-2521191	165.19
2044907		Bushing		95 mm		CTC-6C6093	38.29
JLC1-UP; JLD1-UP							
1799785	Type 2	Bushing		105 mm		CTC-1140760	45.53
1799785	Type 1	Bushing		105 mm		CTC-1140760	45.53
1799785	Type 1	P-UB-10		105 mm	150 mm	CTC-1915619	137.21
1799785	Type 2	P-UB-10		105 mm	150 mm	CTC-2426840	148.46
1915551		P-UB-10		115 mm	170 mm	CTC-2316844	268.77



REPLACEMENT KITS FOR CATERPILLAR® EQUIPMENT

Excavators							
APPLICATION	CYL #	Misc-Parts, Instructions, etc.	CODE	ROD	BORE	KIT #	List \$
MODEL 325C L							
BOOM							
AMH1-UP; BKW1-UP; BMM1-UP; BTD1-UP							
2096006		Bushing	100 mm			CTC-0965625	41.45
2096006		P-UB-10	100 mm	140 mm		CTC-2590634	127.95
BFE1-UP; CRB1-UP; CSJ1-UP; JLC1-UP; JLD1-UP							
1799782		Bushing	100 mm			CTC-1140757	41.78
1799782		P-UB-10	100 mm	140 mm		CTC-2159985	103.63
BKW1-UP; BMM1-UP							
1799789		Bushing	100 mm			CTC-0965625	41.45
1799789		P-UB-10	100 mm	140 mm		CTC-1336823	271.64
1915587		Bushing	100 mm			CTC-0965625	41.45
1915587		P-UB-10	100 mm	140 mm		CTC-2590632	127.95
2590724		Bushing	100 mm			CTC-0965625	41.45
2590724		P-UB-10	100 mm	140 mm		CTC-2590725	127.95
CRB1-UP; CSJ1-UP; JLC1-UP; JLD1-UP							
2113069		Bushing	100 mm			CTC-1140757	41.78
2113069		P-UB-10	100 mm	170 mm		CTC-2519341	223.79
JLC1-UP							
2033906		Bushing	105 mm			CTC-1140760	45.53
2033906		P-UB-10	105 mm	150 mm		CTC-1915619	137.21
JLC1-UP; JLD1-UP							
1915548		Bushing	105 mm			CTC-1140760	45.53
1915548		P-UB-10	105 mm	150 mm		CTC-1915619	137.21
2502419		Bushing	105 mm			CTC-1140760	45.53
2502419		P-UB-10	105 mm	150 mm		CTC-2426840	148.46
BUCKET							
AMH1-UP; BFE1-UP; BTD1-UP; CRB1-UP; CSJ1-UP; JLC1-UP; JLD1-UP							
1772465		Bushing	105 mm			CTC-1140760	45.53
1772465		P-UB-10	105 mm	150 mm		CTC-1915619	137.21
AMH1-UP; BKW1-UP; BMM1-UP; BTD1-UP							
2096011		Bushing	90 mm			CTC-1052575	26.85
2096011		P-UB-10	90 mm	130 mm		CTC-2590627	118.68
AMH1-UP; BTD1-UP; CRB1-UP; CSJ1-UP; JLC1-UP; JLD1-UP							
2478853		Bushing	105 mm			CTC-1140760	45.53
2478853		P-UB-10	105 mm	150 mm		CTC-1915619	137.21
BFE1-UP							
1589061		Bushing	85 mm			CTC-1140756	29.72
1589061		P-U-10	85 mm	120 mm		CTC-2366389	86.07
1799764		Bushing	90 mm			CTC-1140758	34.28
1799764		P-UB-10	90 mm	130 mm		CTC-1799764K	105.79

CATERPILLAR®



REPLACEMENT KITS FOR CATERPILLAR® EQUIPMENT

Excavators							
APPLICATION	CYL #	Misc-Parts, Instructions, etc.	CODE	ROD	BORE	KIT #	List \$
MODEL 325C L							
BUCKET							
BKW1-UP; BMM1-UP							
1799793		Bushing		90 mm		CTC-1052575	26.85
1799793		P-UB-10		90 mm	130 mm	CTC-2590626	118.68
1948276		Bushing		105 mm		CTC-1140760	45.53
1948276		P-UB-10		105 mm	150 mm	CTC-2003315	137.21
2478854		Bushing		105 mm		CTC-1140760	45.53
2478854		P-UB-10		105 mm	150 mm	CTC-2502475	115.12
2590732		Bushing		90 mm		CTC-1052575	26.85
2590732		P-UB-10		90 mm	130 mm	CTC-2590719	120.10
CRB1-UP							
1709808		Bushing		65 mm		CTC-1140754	20.58
1709808		P-UB-10		65 mm	100 mm	CTC-1709941	109.74
2959396		Bushing		65 mm		CTC-1140754	20.58
2959396		P-UB-10		65 mm	100 mm	CTC-1709941	109.74
CRB1-UP; CSJ1-UP; JLC1-UP; JLD1-UP							
1799764		Bushing		90 mm		CTC-1140758	34.28
1799764		P-UB-10		90 mm	130 mm	CTC-2159986	105.79
JLC1-UP							
2201532		Bushing		100 mm		CTC-1140757	41.78
2201532		P-UB-10		100 mm	140 mm	CTC-2159985	103.63
STICK							
AMH1-UP; BKW1-UP; BMM1-UP; BTD1-UP							
1799791		Bushing		105 mm		CTC-0995572	35.65
1799791		P-UB-10		105 mm	150 mm	CTC-1799791K	287.56
2096008		Bushing		105 mm		CTC-0995572	35.65
2096008		P-UB-10		105 mm	150 mm	CTC-2590637	291.00
BFE1-UP							
1799785		Bushing		105 mm		CTC-1140760	45.53
1799785		P-UB-10		105 mm	150 mm	CTC-1799785K	148.46
BKW1-UP; BMM1-UP							
1915589		Bushing		105 mm		CTC-0995572	35.65
1915589		P-UB-10		105 mm	150 mm	CTC-2590636	291.00
2590728		Bushing		105 mm		CTC-0995572	35.65
2590728		P-UB-10		105 mm	150 mm	CTC-2590729	291.00
CRB1-UP; CSJ1-UP							
2188124		Bushing		105 mm		CTC-1140760	45.53
2188124		P-UB-10		105 mm	150 mm	CTC-1884219	137.21
CRB1-UP; CSJ1-UP; JLC1-UP; JLD1-UP							
1799785	Type 1	Bushing		105 mm		CTC-1140760	45.53
1799785	Type 2	Bushing		105 mm		CTC-1140760	45.53
1799785	Type 1	P-UB-10		105 mm	150 mm	CTC-1915619	137.21
1799785	Type 2	P-UB-10		105 mm	150 mm	CTC-2426840	148.46
JLC1-UP							
2044907		P-UB-10		95 mm	160 mm	CTC-2521191	165.19
2044907		Bushing		95 mm		CTC-6C6093	38.29
JLC1-UP; JLD1-UP							
1915551		P-UB-10		115 mm	170 mm	CTC-2316844	268.77



REPLACEMENT KITS FOR CATERPILLAR® EQUIPMENT

Excavators							
APPLICATION	CYL #	Misc-Parts, Instructions, etc.	CODE	ROD	BORE	KIT #	List \$
MODEL 325C LN							
BOOM							
CRB1-UP; CSJ1-UP							
1799782			Bushing	100 mm		CTC-1140757	41.78
1799782			P-UB-10	100 mm	140 mm	CTC-2159985	103.63
2113069			Bushing	100 mm		CTC-1140757	41.78
2113069			P-UB-10	100 mm	170 mm	CTC-2519341	223.79
BUCKET							
CRB1-UP							
1709808			Bushing	65 mm		CTC-1140754	20.58
1709808			P-UB-10	65 mm	100 mm	CTC-1709941	109.74
2959396			Bushing	65 mm		CTC-1140754	20.58
2959396			P-UB-10	65 mm	100 mm	CTC-1709941	109.74
CRB1-UP; CSJ1-UP							
1772465			Bushing	105 mm		CTC-1140760	45.53
1772465			P-UB-10	105 mm	150 mm	CTC-1915619	137.21
1799764			Bushing	90 mm		CTC-1140758	34.28
1799764			P-UB-10	90 mm	130 mm	CTC-2159986	105.79
2478853			Bushing	105 mm		CTC-1140760	45.53
2478853			P-UB-10	105 mm	150 mm	CTC-1915619	137.21
STICK							
CRB1-UP; CSJ1-UP							
1799785	Type 2		Bushing	105 mm		CTC-1140760	45.53
1799785	Type 1		Bushing	105 mm		CTC-1140760	45.53
1799785	Type 1		P-UB-10	105 mm	150 mm	CTC-1915619	137.21
1799785	Type 2		P-UB-10	105 mm	150 mm	CTC-2426840	148.46
2188124			Bushing	105 mm		CTC-1140760	45.53
2188124			P-UB-10	105 mm	150 mm	CTC-1884219	137.21
MODEL 325D							
BOOM							
DBH1-UP; KBE1-UP; KDG1-UP; SCR1-UP							
2254584			Bushing	100 mm		CTC-0965625	41.45
2254584			P-UB-10	100 mm	140 mm	CTC-2344566	123.68
KDG1-UP; SCR1-UP							
2254595			Bushing	100 mm		CTC-0965625	41.45
2254595			P-UB-10	100 mm	140 mm	CTC-2590648	123.68
2667988			Bushing	100 mm		CTC-0965625	41.45
2667988			P-UB-10	100 mm	140 mm	CTC-2668015	118.16
BUCKET							
AZP1-UP; DBH1-UP; KBE1-UP; KDG1-UP; SCR1-UP							
2254581			Bushing	105 mm		CTC-1140760	45.53
2254581			P-UB-10	105 mm	150 mm	CTC-1915619	137.21
DBH1-UP; KBE1-UP; KDG1-UP; SCR1-UP							
2254591			Bushing	95 mm		CTC-0964430	30.24
2254591			P-UB-10	95 mm	135 mm	CTC-2344587	113.49

CATERPILLAR®



REPLACEMENT KITS FOR CATERPILLAR® EQUIPMENT

Excavators							
APPLICATION	CYL #	Misc-Parts, Instructions, etc.	CODE	ROD	BORE	KIT #	List \$
MODEL 325D							
BUCKET							
KDG1-UP; SCR1-UP							
2254599			Bushing	95 mm		CTC-0964430	30.24
2254599			P-UB-10	95 mm	135 mm	CTC-2590656	112.38
2254602			Bushing	105 mm		CTC-1140760	45.53
2254602			P-UB-10	105 mm	150 mm	CTC-2502475	115.12
2667992			Bushing	95 mm		CTC-0964430	30.24
2667992			P-UB-10	95 mm	135 mm	CTC-2668045	113.49
2668080			Bushing	105 mm		CTC-1140760	45.53
2668080			P-UB-10	105 mm	150 mm	CTC-2590743	105.92
STICK							
DBH1-UP; KBE1-UP; KDG1-UP; SCR1-UP							
2254588			Bushing	105 mm		CTC-0995572	35.65
2254588			P-UB-10	105 mm	150 mm	CTC-2344576	284.06
2590778			Bushing	105 mm		CTC-0995572	35.65
2590778			P-UB-10	105 mm	150 mm	CTC-2590779	271.28
KDG1-UP; SCR1-UP							
2254597			Bushing	105 mm		CTC-0995572	35.65
2254597			P-UB-10	105 mm	150 mm	CTC-2590650	284.06
2667990			Bushing	105 mm		CTC-0995572	35.65
2667990			P-UB-10	105 mm	150 mm	CTC-2668016	284.06
MODEL 325D L							
BOOM							
A3R1-UP; GBR1-UP; GPB1-UP; JCL1-UP; MCL1-UP; PAL1-UP; PKE1-UP; T2S1-UP							
2254572			Bushing	100 mm		CTC-1140757	41.78
2254572			P-UB-10	100 mm	140 mm	CTC-2159985	103.63
A3R1-UP; GBR1-UP; GPB1-UP; PKE1-UP							
2959400			Bushing	100 mm		CTC-1140757	41.78
2959400			P-UB-10	100 mm	140 mm	CTC-2478792	156.74
DBH1-UP; KBE1-UP; KDG1-UP; SCR1-UP							
2254584			Bushing	100 mm		CTC-0965625	41.45
2254584			P-UB-10	100 mm	140 mm	CTC-2344566	123.68
GBR1-UP							
2033906			Bushing	105 mm		CTC-1140760	45.53
2033906			P-UB-10	105 mm	150 mm	CTC-1915619	137.21
2795614			P-UB-10	95 mm	160 mm	CTC-2521191	165.19
2795614			Bushing	95 mm		CTC-6C6093	38.29
GBR1-UP; GPB1-UP; LAL1-UP; MCL1-UP; NAC1-UP; PAL1-UP; PKE1-UP; T2S1-UP							
2959398			Bushing	100 mm		CTC-1140757	41.78
2959398			P-UB-10	100 mm	140 mm	CTC-2478792	156.74
GBR1-UP; GPB1-UP; LAL1-UP; MCL1-UP; PKE1-UP; T2S1-UP							
2798111			Bushing	100 mm		CTC-1140757	41.78
2798111			P-UB-10	100 mm	170 mm	CTC-2519341	223.79
KDG1-UP; SCR1-UP							
2254595			Bushing	100 mm		CTC-0965625	41.45
2254595			P-UB-10	100 mm	140 mm	CTC-2590648	123.68
2667988			Bushing	100 mm		CTC-0965625	41.45
2667988			P-UB-10	100 mm	140 mm	CTC-2668015	118.16



REPLACEMENT KITS FOR CATERPILLAR® EQUIPMENT

Excavators							
APPLICATION	CYL #	Misc-Parts, Instructions, etc.	CODE	ROD	BORE	KIT #	List \$
MODEL 325D L							
BUCKET							
A3R1-UP							
2487855		Bushing		65 mm		CTC-1140754	20.58
2487855		P-UB-10		65 mm	100 mm	CTC-1709941	109.74
2836118		Bushing		65 mm		CTC-1140754	20.58
2836118		P-UB-10		65 mm	100 mm	CTC-1709941	109.74
A3R1-UP; AZP1-UP; DBH1-UP; GBR1-UP; GPB1-UP; KBE1-UP; KDG1-UP; MCL1-UP; PKE1-UP; SCR1-UP; T2S1-UP							
2254581		Bushing		105 mm		CTC-1140760	45.53
2254581		P-UB-10		105 mm	150 mm	CTC-1915619	137.21
A3R1-UP; GBR1-UP; GPB1-UP; JCL1-UP; MCL1-UP; PAL1-UP; PKE1-UP; T2S1-UP							
2254578		Bushing		95 mm		CTC-1289260	35.58
2254578		P-UB-10		95 mm	135 mm	CTC-2344488	198.56
A3R1-UP; GBR1-UP; GPB1-UP; LAL1-UP; MCL1-UP; NAC1-UP; PAL1-UP; PKE1-UP							
2898004		Bushing		95 mm		CTC-1289260	35.58
2898004		P-UB-10		95 mm	135 mm	CTC-2344488	198.56
A3R1-UP; GBR1-UP; GPB1-UP; LAL1-UP; MCL1-UP; NAC1-UP; PAL1-UP; PKE1-UP; T2S1-UP							
2898012		Bushing		105 mm		CTC-1140760	45.53
2898012		P-UB-10		105 mm	150 mm	CTC-1915619	137.21
DBH1-UP; KBE1-UP; KDG1-UP; SCR1-UP							
2254591		Bushing		95 mm		CTC-0964430	30.24
2254591		P-UB-10		95 mm	135 mm	CTC-2344587	113.49
GBR1-UP							
2201532		Bushing		100 mm		CTC-1140757	41.78
2201532		P-UB-10		100 mm	140 mm	CTC-2159985	103.63
2897948		Bushing		85 mm		CTC-1140756	29.72
2897948		P-UB-10		85 mm	120 mm	CTC-2478790	86.07
GBR1-UP; GPB1-UP; MCL1-UP; PKE1-UP							
2426767		Bushing		85 mm		CTC-1140756	29.72
2426767		P-UB-10		85 mm	120 mm	CTC-2478790	86.07
GPB1-UP							
2959396		Bushing		65 mm		CTC-1140754	20.58
2959396		P-UB-10		65 mm	100 mm	CTC-1709941	109.74
3095975		Bushing		65 mm		CTC-1140754	20.58
3095975		P-UB-10		65 mm	100 mm	CTC-1709941	109.74
KDG1-UP; SCR1-UP							
2254599		Bushing		95 mm		CTC-0964430	30.24
2254599		P-UB-10		95 mm	135 mm	CTC-2590656	112.38
2254602		Bushing		105 mm		CTC-1140760	45.53
2254602		P-UB-10		105 mm	150 mm	CTC-2502475	115.12
2667992		Bushing		95 mm		CTC-0964430	30.24
2667992		P-UB-10		95 mm	135 mm	CTC-2668045	113.49
2668080		Bushing		105 mm		CTC-1140760	45.53
2668080		P-UB-10		105 mm	150 mm	CTC-2590743	105.92
STICK							
A3R1-UP							
2166607		Bushing		105 mm		CTC-1140760	45.53
2166607		P-UB-10		105 mm	150 mm	CTC-1915619	137.21

CATERPILLAR®



REPLACEMENT KITS FOR CATERPILLAR® EQUIPMENT

Excavators

APPLICATION	CYL #	Misc-Parts, Instructions, etc.	CODE	ROD	BORE	KIT #	List \$
MODEL 325D L							
STICK							
A3R1-UP; GBR1-UP; GPB1-UP; JCL1-UP; MCL1-UP; PAL1-UP; PKE1-UP; T2S1-UP							
2254575		Bushing		105 mm		CTC-1140760	45.53
2254575		P-UB-10		105 mm	150 mm	CTC-2426840	148.46
A3R1-UP; GBR1-UP; GPB1-UP; LAL1-UP; MCL1-UP; NAC1-UP; PAL1-UP; PKE1-UP; T2S1-UP							
2897994		Bushing		105 mm		CTC-1140760	45.53
2897994		P-UB-10		105 mm	150 mm	CTC-2426840	148.46
DBH1-UP; KBE1-UP; KDG1-UP; SCR1-UP							
2254588		Bushing		105 mm		CTC-0995572	35.65
2254588		P-UB-10		105 mm	150 mm	CTC-2344576	284.06
2590778		Bushing		105 mm		CTC-0995572	35.65
2590778		P-UB-10		105 mm	150 mm	CTC-2590779	271.28
GBR1-UP							
2344601		P-UB-10		115 mm	170 mm	CTC-2316844	268.77
2836188		P-UB-10		115 mm	170 mm	CTC-2316844	268.77
2898031		P-UB-10		115 mm	170 mm	CTC-2316844	268.77
KDG1-UP; SCR1-UP							
2254597		Bushing		105 mm		CTC-0995572	35.65
2254597		P-UB-10		105 mm	150 mm	CTC-2590650	284.06
2667990		Bushing		105 mm		CTC-0995572	35.65
2667990		P-UB-10		105 mm	150 mm	CTC-2668016	284.06
MODEL 325D LN							
BOOM							
GPB1-UP; PKE1-UP							
2254572		Bushing		100 mm		CTC-1140757	41.78
2254572		P-UB-10		100 mm	140 mm	CTC-2159985	103.63
2798111		Bushing		100 mm		CTC-1140757	41.78
2798111		P-UB-10		100 mm	170 mm	CTC-2519341	223.79
2959398		Bushing		100 mm		CTC-1140757	41.78
2959398		P-UB-10		100 mm	140 mm	CTC-2478792	156.74
2959400		Bushing		100 mm		CTC-1140757	41.78
2959400		P-UB-10		100 mm	140 mm	CTC-2478792	156.74
BUCKET							
GPB1-UP							
2959396		Bushing		65 mm		CTC-1140754	20.58
2959396		P-UB-10		65 mm	100 mm	CTC-1709941	109.74
3095975		Bushing		65 mm		CTC-1140754	20.58
3095975		P-UB-10		65 mm	100 mm	CTC-1709941	109.74

CATERPILLAR®



REPLACEMENT KITS FOR CATERPILLAR® EQUIPMENT

Excavators							
APPLICATION	CYL #	Misc-Parts, Instructions, etc.	CODE	ROD	BORE	KIT #	List \$
MODEL 325D LN							
BUCKET							
GPB1-UP; PKE1-UP							
2254578		Bushing		95 mm		CTC-1289260	35.58
2254578		P-UB-10		95 mm	135 mm	CTC-2344488	198.56
2254581		Bushing		105 mm		CTC-1140760	45.53
2254581		P-UB-10		105 mm	150 mm	CTC-1915619	137.21
2426767		Bushing		85 mm		CTC-1140756	29.72
2426767		P-UB-10		85 mm	120 mm	CTC-2478790	86.07
2898004		Bushing		95 mm		CTC-1289260	35.58
2898004		P-UB-10		95 mm	135 mm	CTC-2344488	198.56
2898012		Bushing		105 mm		CTC-1140760	45.53
2898012		P-UB-10		105 mm	150 mm	CTC-1915619	137.21
STICK							
GPB1-UP; PKE1-UP							
2254575		Bushing		105 mm		CTC-1140760	45.53
2254575		P-UB-10		105 mm	150 mm	CTC-2426840	148.46
2897994		Bushing		105 mm		CTC-1140760	45.53
2897994		P-UB-10		105 mm	150 mm	CTC-2426840	148.46
MODEL 325L							
BOOM							
	7Y4601		P-UB-10	95 mm	130 mm	CTC-7Y5147	252.83
BUCKET							
	1251547		P-UB-10	65 mm	100 mm	CTC-418914	172.89
	417652		P-UB-10	65 mm	100 mm	CTC-417664	172.96
	418840		P-UB-10	65 mm	100 mm	CTC-418914	172.89
	717291		P-UB-10	85 mm	130 mm	CTC-7Y5145	226.08
	7Y5100		P-UB-10	85 mm	130 mm	CTC-7Y5145	226.08
	7Y5150		P-UB-10	105 mm	150 mm	CTC-1163612	255.25
	875633		P-UB-10	85 mm	120 mm	CTC-0875394	218.89
STICK							
	1169123		P-UB-10	105 mm	150 mm	CTC-1163612	255.25
	7Y4650		P-UB-10	105 mm	150 mm	CTC-1163612	255.25
MODEL 325N							
BOOM							
	7Y4601		P-UB-10	95 mm	130 mm	CTC-7Y5147	252.83
BUCKET							
	7Y5100		P-UB-10	85 mm	130 mm	CTC-7Y5145	226.08
	7Y5150		P-UB-10	105 mm	150 mm	CTC-1163612	255.25
	875633		P-UB-10	85 mm	120 mm	CTC-0875394	218.89
STICK							
	7Y4650		P-UB-10	105 mm	150 mm	CTC-1163612	255.25
MODEL 330							
BOOM							
	7Y4906		P-UB-10	105 mm	150 mm	CTC-1163612	255.25

CATERPILLAR®



REPLACEMENT KITS FOR CATERPILLAR® EQUIPMENT

Excavators							
APPLICATION	CYL #	Misc-Parts, Instructions, etc.	CODE	ROD	BORE	KIT #	List \$
MODEL 330							
BUCKET							
	0875531		P-UB-10	110 mm	160 mm	CTC-0876654	271.50
	0875633		P-UB-10	85 mm	120 mm	CTC-0875394	218.89
	7Y5100		P-UB-10	85 mm	130 mm	CTC-7Y5145	226.08
	7Y5150		P-UB-10	105 mm	150 mm	CTC-1163612	255.25
STICK							
	7Y4926		P-UB-10	110 mm	170 mm	CTC-1163649	318.56
MODEL 330B, 330BL							
BOOM							
	1163578		P-UB-10	105 mm	150 mm	CTC-1680758	295.22
	1336808		P-UB-10	105 mm	150 mm	CTC-1289277	311.24
BUCKET							
	1183921		P-UB-10	105 mm	150 mm	CTC-1680758	295.22
	1183935		P-UB-10	110 mm	160 mm	CTC-1680760	328.81
	1184134		P-UB-10	85 mm	120 mm	CTC-1184131	211.36
	1336810		P-UB-10	105 mm	150 mm	CTC-1289277	311.24
	1336811		P-UB-10	110 mm	160 mm	CTC-1289280	325.95
STICK							
	0875375		P-UB-10	130 mm	180 mm	CTC-0875407	336.78
	1163638		P-UB-10	110 mm	170 mm	CTC-1680759	338.96
	1336809		P-UB-10	110 mm	170 mm	CTC-1289278	336.06
MODEL 330C							
BOOM							
GKX1-UP; JAB1-UP; JCD1-UP; JNK1-UP; KDD1-UP; MCA1-UP							
	1915548		Bushing	105 mm		CTC-1140760	45.53
	1915548		P-UB-10	105 mm	150 mm	CTC-1915619	137.21
GKX1-UP; JAB1-UP; KDD1-UP; MCA1-UP							
	2502473		Bushing	105 mm		CTC-1140760	45.53
	2502473		P-UB-10	105 mm	150 mm	CTC-2502475	115.12
GKX1-UP; MCA1-UP							
	2502419		Bushing	105 mm		CTC-1140760	45.53
	2502419		P-UB-10	105 mm	150 mm	CTC-2426840	148.46
JAB1-UP; KDD1-UP							
	1948270		Bushing	105 mm		CTC-1140760	45.53
	1948270		P-UB-10	105 mm	150 mm	CTC-2003315	137.21
	2502419		Bushing	105 mm		CTC-1140760	45.53
	2502419		P-UB-10	105 mm	150 mm	CTC-2426840	148.46
	2590742		Bushing	105 mm		CTC-1140760	45.53
	2590742		P-UB-10	105 mm	150 mm	CTC-2590743	105.92
JCD1-UP; JNK1-UP							
	2502419		Bushing	105 mm		CTC-1140760	45.53
	2502419		P-UB-10	105 mm	150 mm	CTC-2426840	148.46



REPLACEMENT KITS FOR CATERPILLAR® EQUIPMENT

Excavators							
APPLICATION	CYL #	Misc-Parts, Instructions, etc.	CODE	ROD	BORE	KIT #	List \$
MODEL 330C							
BUCKET							
GKX1-UP; JAB1-UP; JCD1-UP; JNK1-UP; KDD1-UP; MCA1-UP							
1772465		Bushing		105 mm		CTC-1140760	45.53
1772465		P-UB-10		105 mm	150 mm	CTC-1915619	137.21
1915554		Bushing		110 mm		CTC-1140762	67.76
1915554		P-UB-10		110 mm	160 mm	CTC-2159988	169.01
2478853		Bushing		105 mm		CTC-1140760	45.53
2478853		P-UB-10		105 mm	150 mm	CTC-1915619	137.21
GKX1-UP; JAB1-UP; KDD1-UP; MCA1-UP							
2478854		Bushing		105 mm		CTC-1140760	45.53
2478854		P-UB-10		105 mm	150 mm	CTC-2502475	115.12
JAB1-UP; KDD1-UP							
1948276		Bushing		105 mm		CTC-1140760	45.53
1948276		P-UB-10		105 mm	150 mm	CTC-2003315	137.21
1948279		Bushing		110 mm		CTC-1140762	67.76
1948279		P-UB-10		110 mm	160 mm	CTC-1948235	200.19
2590746		Bushing		105 mm		CTC-1140760	45.53
2590746		P-UB-10		105 mm	150 mm	CTC-2590743	105.92
2590750		Bushing		110 mm		CTC-1140762	67.76
2590750		P-UB-10		110 mm	160 mm	CTC-2590751	194.75
JCD1-UP							
1709808		Bushing		65 mm		CTC-1140754	20.58
1709808		P-UB-10		65 mm	100 mm	CTC-1709941	109.74
2959396		Bushing		65 mm		CTC-1140754	20.58
2959396		P-UB-10		65 mm	100 mm	CTC-1709941	109.74
JCD1-UP; JNK1-UP							
1589061		Bushing		85 mm		CTC-1140756	29.72
1589061		P-U-10		85 mm	120 mm	CTC-2366389	86.07
2836132		Bushing		85 mm		CTC-1140756	29.72
2836132		P-UB-10		85 mm	120 mm	CTC-2366368	86.07
STICK							
GKX1-UP; JAB1-UP; KDD1-UP; MCA1-UP							
1915551		P-UB-10		115 mm	170 mm	CTC-2316844	268.77
1948273		P-UB-10		115 mm	170 mm	CTC-2316845	274.41
2897763		P-UB-10		115 mm	170 mm	CTC-2316844	268.77
2897780		P-UB-10		115 mm	170 mm	CTC-2316845	274.41
JAB1-UP; KDD1-UP							
2590767		P-UB-10		115 mm	170 mm	CTC-2590768	273.44
2897784		P-UB-10		115 mm	170 mm	CTC-2590768	273.44
JCD1-UP; JNK1-UP							
1915551		P-UB-10		115 mm	170 mm	CTC-2316844	268.77
UNSPECIFIED APPLICATION							
JCD1-UP; JNK1-UP							
1234121		P-UB-10		2	4	CTC-1234121K	64.77
1702109		I-UB-10		125 mm	220 mm	CTC-1702156	735.85

CATERPILLAR®



REPLACEMENT KITS FOR CATERPILLAR® EQUIPMENT

Excavators							
APPLICATION	CYL #	Misc-Parts, Instructions, etc.	CODE	ROD	BORE	KIT #	List \$
MODEL 330C L							
BOOM							
CAP1-UP; CGZ1-UP							
2255306		Bushing		110 mm		CTC-1140762	67.76
2255306		P-UB-10		110 mm	180 mm	CTC-2304001	222.22
CAP1-UP; CGZ1-UP; GKX1-UP; JAB1-UP; JCD1-UP; JNK1-UP; KDD1-UP; MCA1-UP; MKM1-UP							
1915548		Bushing		105 mm		CTC-1140760	45.53
1915548		P-UB-10		105 mm	150 mm	CTC-1915619	137.21
CAP1-UP; CGZ1-UP; JCD1-UP; JNK1-UP							
2502419		Bushing		105 mm		CTC-1140760	45.53
2502419		P-UB-10		105 mm	150 mm	CTC-2426840	148.46
CYA1-UP							
1915548		Bushing		105 mm		CTC-1140760	45.53
1915548		P-UB-10		105 mm	150 mm	CTC-1884219	137.21
DKY1-UP							
1915548		Bushing		105 mm		CTC-1140760	45.53
1915548		P-UB-10		105 mm	150 mm	CTC-1884219	137.21
GKX1-UP; JAB1-UP; KDD1-UP; MCA1-UP							
2502473		Bushing		105 mm		CTC-1140760	45.53
2502473		P-UB-10		105 mm	150 mm	CTC-2502475	115.12
GKX1-UP; MCA1-UP; CYA1-UP							
2502419		Bushing		105 mm		CTC-1140760	45.53
2502419		P-UB-10		105 mm	150 mm	CTC-2426840	148.46
JAB1-UP; KDD1-UP							
1948270		Bushing		105 mm		CTC-1140760	45.53
1948270		P-UB-10		105 mm	150 mm	CTC-2003315	137.21
2502419		Bushing		105 mm		CTC-1140760	45.53
2502419		P-UB-10		105 mm	150 mm	CTC-2426840	148.46
2590742		Bushing		105 mm		CTC-1140760	45.53
2590742		P-UB-10		105 mm	150 mm	CTC-2590743	105.92
MKM1-UP							
2162731		Bushing		110 mm		CTC-1140762	67.76
2162731		P-UB-10		110 mm	160 mm	CTC-2042721	196.44
BUCKET							
CAP1-UP; CGZ1-UP; DKY1-UP; GKX1-UP; JAB1-UP; JCD1-UP; JNK1-UP; KDD1-UP; MCA1-UP; MKM1-UP							
1772465		Bushing		105 mm		CTC-1140760	45.53
1772465		P-UB-10		105 mm	150 mm	CTC-1915619	137.21
1915554		Bushing		110 mm		CTC-1140762	67.76
1915554		P-UB-10		110 mm	160 mm	CTC-2159988	169.01
CAP1-UP; CGZ1-UP; GKX1-UP; JAB1-UP; JCD1-UP; JNK1-UP; KDD1-UP; MCA1-UP; MKM1-UP							
2478853		Bushing		105 mm		CTC-1140760	45.53
2478853		P-UB-10		105 mm	150 mm	CTC-1915619	137.21
CYA1-UP							
1772465		Bushing		105 mm		CTC-1140760	45.53
1772465		P-UB-10		105 mm	150 mm	CTC-1884219	137.21
1915554		Bushing		110 mm		CTC-1140762	67.76
1915554		P-UB-10		110 mm	160 mm	CTC-1948396	179.15



REPLACEMENT KITS FOR CATERPILLAR® EQUIPMENT

Excavators							
APPLICATION	CYL #	Misc-Parts, Instructions, etc.	CODE	ROD	BORE	KIT #	List \$
MODEL 330C L							
BUCKET							
GKX1-UP; JAB1-UP; KDD1-UP; MCA1-UP							
2478854		Bushing	105 mm			CTC-1140760	45.53
2478854		P-UB-10	105 mm	150 mm		CTC-2502475	115.12
JAB1-UP; KDD1-UP							
1948276		Bushing	105 mm			CTC-1140760	45.53
1948276		P-UB-10	105 mm	150 mm		CTC-2003315	137.21
1948279		Bushing	110 mm			CTC-1140762	67.76
1948279		P-UB-10	110 mm	160 mm		CTC-1948235	200.19
2590746		Bushing	105 mm			CTC-1140760	45.53
2590746		P-UB-10	105 mm	150 mm		CTC-2590743	105.92
2590750		Bushing	110 mm			CTC-1140762	67.76
2590750		P-UB-10	110 mm	160 mm		CTC-2590751	194.75
JCD1-UP							
1709808		Bushing	65 mm			CTC-1140754	20.58
1709808		P-UB-10	65 mm	100 mm		CTC-1709941	109.74
2959396		Bushing	65 mm			CTC-1140754	20.58
2959396		P-UB-10	65 mm	100 mm		CTC-1709941	109.74
JCD1-UP; JNK1-UP							
1589061		Bushing	85 mm			CTC-1140756	29.72
1589061		P-U-10	85 mm	120 mm		CTC-2366389	86.07
2836132		Bushing	85 mm			CTC-1140756	29.72
2836132		P-UB-10	85 mm	120 mm		CTC-2366368	86.07
STICK							
CAP1-UP; CGZ1-UP; JCD1-UP; JNK1-UP; MKM1-UP							
1915551		P-UB-10	115 mm	170 mm		CTC-2316844	268.77
CYA1-UP							
1915551		P-UB-10	115 mm	170 mm		CTC-1915649	268.77
CYA1-UP; GKX1-UP; JAB1-UP; KDD1-UP; MCA1-UP							
2897763		P-UB-10	115 mm	170 mm		CTC-2316844	268.77
DKY1-UP							
1915551		P-UB-10	115 mm	170 mm		CTC-1915551K	238.22
GKX1-UP; JAB1-UP; KDD1-UP; MCA1-UP							
1915551		P-UB-10	115 mm	170 mm		CTC-2316844	268.77
1948273		P-UB-10	115 mm	170 mm		CTC-2316845	274.41
2897780		P-UB-10	115 mm	170 mm		CTC-2316845	274.41
JAB1-UP; KDD1-UP							
2590767		P-UB-10	115 mm	170 mm		CTC-2590768	273.44
2897784		P-UB-10	115 mm	170 mm		CTC-2590768	273.44
MKM1-UP							
2141591		Bushing	90 mm			CTC-1140758	34.28
2141591		P-UB-10	90 mm	130 mm		CTC-2119614	133.60
2228776		Bushing	100 mm			CTC-1140757	41.78
2228776		P-UB-10	100 mm	140 mm		CTC-2159985	103.63
UNSPECIFIED APPLICATION							
CAP1-UP; JCD1-UP; JNK1-UP							
1234121		P-UB-10	2	4		CTC-1234121K	64.77

CATERPILLAR®



REPLACEMENT KITS FOR CATERPILLAR® EQUIPMENT

Excavators							
APPLICATION	CYL #	Misc-Parts, Instructions, etc.	CODE	ROD	BORE	KIT #	List \$
MODEL 330C L							
UNSPECIFIED APPLICATION							
JCD1-UP; JNK1-UP							
	1702109		I-UB-10	125 mm	220 mm	CTC-1702156	735.85
MODEL 330C LN							
BOOM							
CAP1-UP; CGZ1-UP							
	1915548		Bushing	105 mm		CTC-1140760	45.53
	1915548		P-UB-10	105 mm	150 mm	CTC-1915619	137.21
	2255306		Bushing	110 mm		CTC-1140762	67.76
	2255306		P-UB-10	110 mm	180 mm	CTC-2304001	222.22
	2502419		Bushing	105 mm		CTC-1140760	45.53
	2502419		P-UB-10	105 mm	150 mm	CTC-2426840	148.46
BUCKET							
CAP1-UP; CGZ1-UP							
	1772465		Bushing	105 mm		CTC-1140760	45.53
	1772465		P-UB-10	105 mm	150 mm	CTC-1915619	137.21
	1915554		Bushing	110 mm		CTC-1140762	67.76
	1915554		P-UB-10	110 mm	160 mm	CTC-2159988	169.01
	2478853		Bushing	105 mm		CTC-1140760	45.53
	2478853		P-UB-10	105 mm	150 mm	CTC-1915619	137.21
STICK							
CAP1-UP; CGZ1-UP							
	1915551		P-UB-10	115 mm	170 mm	CTC-2316844	268.77
UNSPECIFIED APPLICATION							
CAP1-UP							
	1234121		P-UB-10	2	4	CTC-1234121K	64.77
MODEL 330D							
BOOM							
EAH1-UP; EDX1-UP; ERN1-UP; FFK1-UP; MEY1-UP; NBD1-UP; THJ1-UP							
	2344598		Bushing	105 mm		CTC-1140760	45.53
	2344598		P-UB-10	105 mm	150 mm	CTC-2426840	148.46
EAH1-UP; FFK1-UP							
	3119517		Bushing	105 mm		CTC-1140760	45.53
	3119517		P-UB-10	105 mm	150 mm	CTC-2426840	148.46
	3119524		Bushing	105 mm		CTC-1140760	45.53
	3119524		P-UB-10	105 mm	150 mm	CTC-2502475	115.12
EAH1-UP; FFK1-UP; MEY1-UP; NBD1-UP							
	2344608		Bushing	105 mm		CTC-1140760	45.53
	2344608		P-UB-10	105 mm	150 mm	CTC-2502475	115.12
EDX1-UP; MEY1-UP; NBD1-UP							
	2668074		Bushing	105 mm		CTC-1140760	45.53
	2668074		P-UB-10	105 mm	150 mm	CTC-2590743	105.92
	2898021		Bushing	105 mm		CTC-1140760	45.53
	2898021		P-UB-10	105 mm	150 mm	CTC-2426840	148.46
MEY1-UP; NBD1-UP							
	2898050		Bushing	105 mm		CTC-1140760	45.53
	2898050		P-UB-10	105 mm	150 mm	CTC-2502475	115.12

CATERPILLAR®



REPLACEMENT KITS FOR CATERPILLAR® EQUIPMENT

Excavators							
APPLICATION	CYL #	Misc-Parts, Instructions, etc.	CODE	ROD	BORE	KIT #	List \$
MODEL 330D							
BUCKET							
EAH1-UP; EDX1-UP; ERN1-UP; FFK1-UP; MEY1-UP; NBD1-UP; THJ1-UP							
2254581		Bushing	105 mm			CTC-1140760	45.53
2254581		P-UB-10	105 mm	150 mm		CTC-1915619	137.21
2344604		Bushing	110 mm			CTC-1140762	67.76
2344604		P-UB-10	110 mm	160 mm		CTC-2254625	228.21
EAH1-UP; FFK1-UP; MEY1-UP; NBD1-UP							
2254602		Bushing	105 mm			CTC-1140760	45.53
2254602		P-UB-10	105 mm	150 mm		CTC-2502475	115.12
2344614		Bushing	110 mm			CTC-1140762	67.76
2344614		P-UB-10	110 mm	160 mm		CTC-1948235	200.19
EDX1-UP; MEY1-UP; NBD1-UP							
2668083		Bushing	110 mm			CTC-1140762	67.76
2668083		P-UB-10	110 mm	160 mm		CTC-2590751	194.75
ERN1-UP; THJ1-UP							
2426767		Bushing	85 mm			CTC-1140756	29.72
2426767		P-UB-10	85 mm	120 mm		CTC-2478790	86.07
2898012		Bushing	105 mm			CTC-1140760	45.53
2898012		P-UB-10	105 mm	150 mm		CTC-1915619	137.21
2898041		Bushing	110 mm			CTC-1140762	67.76
2898041		P-UB-10	110 mm	160 mm		CTC-2254625	228.21
STICK							
EAH1-UP; EDX1-UP; ERN1-UP; FFK1-UP; MEY1-UP; NBD1-UP; THJ1-UP							
2344601		P-UB-10	115 mm	170 mm		CTC-2316844	268.77
2836188		P-UB-10	115 mm	170 mm		CTC-2316844	268.77
EAH1-UP; FFK1-UP; MEY1-UP; NBD1-UP							
2836194		P-UB-10	115 mm	170 mm		CTC-2316845	274.41
EDX1-UP; MEY1-UP; NBD1-UP							
2668077		P-UB-10	115 mm	170 mm		CTC-2590768	273.44
2836195		P-UB-10	115 mm	170 mm		CTC-2590768	273.44
2898031		P-UB-10	115 mm	170 mm		CTC-2316844	268.77
MEY1-UP; NBD1-UP							
2344611		P-UB-10	115 mm	170 mm		CTC-2316845	274.41
2898053		P-UB-10	115 mm	170 mm		CTC-2316845	274.41
MODEL 330D L							
BOOM							
B6H1-UP; EAH1-UP; EDX1-UP; FFK1-UP; GGE1-UP; HAS1-UP; JLP1-UP; MAG1-UP; MEY1-UP; MWP1-UP; NBD1-UP; RAS1-UP; T2Y1-UP							
2344598		Bushing	105 mm			CTC-1140760	45.53
2344598		P-UB-10	105 mm	150 mm		CTC-2426840	148.46
B6H1-UP; EDX1-UP; GGE1-UP; JLP1-UP; LRM1-UP; MEY1-UP; MWP1-UP; NBD1-UP; RAS1-UP; T2Y1-UP							
2898021		Bushing	105 mm			CTC-1140760	45.53
2898021		P-UB-10	105 mm	150 mm		CTC-2426840	148.46
EAH1-UP; FFK1-UP							
3119517		Bushing	105 mm			CTC-1140760	45.53
3119517		P-UB-10	105 mm	150 mm		CTC-2426840	148.46
3119524		Bushing	105 mm			CTC-1140760	45.53
3119524		P-UB-10	105 mm	150 mm		CTC-2502475	115.12

CATERPILLAR®



REPLACEMENT KITS FOR CATERPILLAR® EQUIPMENT

Excavators							
APPLICATION	CYL #	Misc-Parts, Instructions, etc.	CODE	ROD	BORE	KIT #	List \$
MODEL 330D L							
BOOM							
EAH1-UP; FFK1-UP; MEY1-UP; NBD1-UP							
2344608		Bushing		105 mm		CTC-1140760	45.53
2344608		P-UB-10		105 mm	150 mm	CTC-2502475	115.12
EDX1-UP; MEY1-UP; NBD1-UP							
2668074		Bushing		105 mm		CTC-1140760	45.53
2668074		P-UB-10		105 mm	150 mm	CTC-2590743	105.92
GGE1-UP; RAS1-UP							
2255306		Bushing		110 mm		CTC-1140762	67.76
2255306		P-UB-10		110 mm	180 mm	CTC-2304001	222.22
MEY1-UP; NBD1-UP							
2898050		Bushing		105 mm		CTC-1140760	45.53
2898050		P-UB-10		105 mm	150 mm	CTC-2502475	115.12
BUCKET							
B6H1-UP; EAH1-UP; EDX1-UP; FFK1-UP; GGE1-UP; HAS1-UP; JLP1-UP; MAG1-UP; MEY1-UP; MWP1-UP; NBD1-UP; RAS1-UP; T2Y1-UP							
2254581		Bushing		105 mm		CTC-1140760	45.53
2254581		P-UB-10		105 mm	150 mm	CTC-1915619	137.21
B6H1-UP; EAH1-UP; EDX1-UP; FFK1-UP; GGE1-UP; JLP1-UP; MEY1-UP; NBD1-UP; RAS1-UP; T2Y1-UP							
2344604		Bushing		110 mm		CTC-1140762	67.76
2344604		P-UB-10		110 mm	160 mm	CTC-2254625	228.21
B6H1-UP; GGE1-UP; HAS1-UP; JLP1-UP; LRM1-UP; MWP1-UP; RAS1-UP; T2Y1-UP							
2898012		Bushing		105 mm		CTC-1140760	45.53
2898012		P-UB-10		105 mm	150 mm	CTC-1915619	137.21
EAH1-UP; FFK1-UP; MEY1-UP; NBD1-UP							
2254602		Bushing		105 mm		CTC-1140760	45.53
2254602		P-UB-10		105 mm	150 mm	CTC-2502475	115.12
2344614		Bushing		110 mm		CTC-1140762	67.76
2344614		P-UB-10		110 mm	160 mm	CTC-1948235	200.19
EDX1-UP; MEY1-UP; NBD1-UP							
2668083		Bushing		110 mm		CTC-1140762	67.76
2668083		P-UB-10		110 mm	160 mm	CTC-2590751	194.75
GGE1-UP; HAS1-UP; LRM1-UP; MWP1-UP; RAS1-UP; T2Y1-UP							
2898041		Bushing		110 mm		CTC-1140762	67.76
2898041		P-UB-10		110 mm	160 mm	CTC-2254625	228.21
MWP1-UP							
2254529		Bushing		110 mm		CTC-1140762	67.76
2254529		P-UB-10		110 mm	160 mm	CTC-2254625	228.21
STICK							
B6H1-UP; EAH1-UP; EDX1-UP; FFK1-UP; GGE1-UP; HAS1-UP; JLP1-UP; MEY1-UP; MWP1-UP; NBD1-UP; RAS1-UP; T2Y1-UP							
2344601		P-UB-10		115 mm	170 mm	CTC-2316844	268.77
EAH1-UP; EDX1-UP; FFK1-UP; HAS1-UP; MAG1-UP; MEY1-UP; NBD1-UP; T2Y1-UP							
2836188		P-UB-10		115 mm	170 mm	CTC-2316844	268.77
EAH1-UP; FFK1-UP; MEY1-UP; NBD1-UP							
2836194		P-UB-10		115 mm	170 mm	CTC-2316845	274.41
EDX1-UP; GGE1-UP; MEY1-UP; NBD1-UP; RAS1-UP; T2Y1-UP; B6H1-UP; JLP1-UP; LRM1-UP							
2898031		P-UB-10		115 mm	170 mm	CTC-2316844	268.77



REPLACEMENT KITS FOR CATERPILLAR® EQUIPMENT

Excavators							
APPLICATION	CYL #	Misc-Parts, Instructions, etc.	CODE	ROD	BORE	KIT #	List \$
MODEL 330D L							
STICK							
EDX1-UP; MEY1-UP; NBD1-UP							
2668077			P-UB-10	115 mm	170 mm	CTC-2590768	273.44
2836195			P-UB-10	115 mm	170 mm	CTC-2590768	273.44
MEY1-UP; NBD1-UP							
2344611			P-UB-10	115 mm	170 mm	CTC-2316845	274.41
2898053			P-UB-10	115 mm	170 mm	CTC-2316845	274.41
MWP1-UP							
2898031			P-UB-10	115 mm	170 mm	CTC-2316844	268.77
MODEL 330D N							
BOOM							
GGE1-UP; RAS1-UP							
2255306			Bushing	110 mm		CTC-1140762	67.76
2255306			P-UB-10	110 mm	180 mm	CTC-2304001	222.22
2344598			Bushing	105 mm		CTC-1140760	45.53
2344598			P-UB-10	105 mm	150 mm	CTC-2426840	148.46
2898021			Bushing	105 mm		CTC-1140760	45.53
2898021			P-UB-10	105 mm	150 mm	CTC-2426840	148.46
BUCKET							
GGE1-UP; RAS1-UP							
2254581			Bushing	105 mm		CTC-1140760	45.53
2254581			P-UB-10	105 mm	150 mm	CTC-1915619	137.21
2344604			Bushing	110 mm		CTC-1140762	67.76
2344604			P-UB-10	110 mm	160 mm	CTC-2254625	228.21
2898012			Bushing	105 mm		CTC-1140760	45.53
2898012			P-UB-10	105 mm	150 mm	CTC-1915619	137.21
2898041			Bushing	110 mm		CTC-1140762	67.76
2898041			P-UB-10	110 mm	160 mm	CTC-2254625	228.21
STICK							
GGE1-UP; RAS1-UP							
2344601			P-UB-10	115 mm	170 mm	CTC-2316844	268.77
2898031			P-UB-10	115 mm	170 mm	CTC-2316844	268.77
MODEL 330L							
BOOM							
7Y4906			P-UB-10	105 mm	150 mm	CTC-1163612	255.25
BUCKET							
1183921			P-UB-10	105 mm	150 mm	CTC-1163612	255.25
1183935			P-UB-10	110 mm	160 mm	CTC-1183946	308.49
4I1726			P-UB-10	110 mm	160 mm	CTC-0876654	271.50
7Y5100			P-UB-10	85 mm	130 mm	CTC-7Y5145	226.08
7Y5150			P-UB-10	105 mm	150 mm	CTC-1163612	255.25
875531			P-UB-10	110 mm	160 mm	CTC-0876654	271.50
STICK							
1163638			P-UB-10	110 mm	170 mm	CTC-1163649	318.56
7Y4926			P-UB-10	110 mm	170 mm	CTC-1163649	318.56
TILT							
1163578			P-UB-10	105 mm	150 mm	CTC-1163612	255.25

CATERPILLAR®



REPLACEMENT KITS FOR CATERPILLAR® EQUIPMENT

Excavators							
APPLICATION	CYL #	Misc-Parts, Instructions, etc.	CODE	ROD	BORE	KIT #	List \$
MODEL 345B, 345BL							
BOOM							
	1297829		P-UB-10	110 mm	160 mm	CTC-1680760	328.81
	1553737		P-UB-10	110 mm	160 mm	CTC-1680760	328.81
BUCKET							
	1183935		P-UB-10	110 mm	160 mm	CTC-1680760	328.81
	1184134		P-UB-10	85 mm	120 mm	CTC-1184131	211.36
	1232044		P-UB-10	90 mm	130 mm	CTC-1184175	249.77
	1297835		P-UB-10	110 mm	170 mm	CTC-1680759	338.96
COUNTERWEIGHT							
	1231078		P-UB-10	3	4-3/4	CTC-1570288	145.81
MATERIAL HANDLER							
	1504125		P-UB-10	110 mm	170 mm	CTC-1680759	338.96
STEERING							
	1151371		P-UB-10	2-1/4	4	CTC-1546526	127.50
STICK							
	1163638		P-UB-10	110 mm	170 mm	CTC-1680759	338.96
	1297832		P-UB-10	130 mm	190 mm	CTC-1261979	248.96
MODEL 345C							
BOOM							
BWY1-UP; ELS1-UP; GCL1-UP; TAJ1-UP; TBA1-UP; WDE1-UP							
	2254523		Bushing	110 mm		CTC-1140762	67.76
	2254523		P-UB-10	110 mm	160 mm	CTC-2254625	228.21
BWY1-UP; TBA1-UP; WDE1-UP							
	2668087		Bushing	110 mm		CTC-1140762	67.76
	2668087		P-UB-10	110 mm	160 mm	CTC-2742460	223.74
BUCKET							
BWY1-UP; ELS1-UP; GCL1-UP; TAJ1-UP; TBA1-UP; WDE1-UP							
	2254529		Bushing	110 mm		CTC-1140762	67.76
	2254529		P-UB-10	110 mm	160 mm	CTC-2254625	228.21
	2254532		Bushing	110 mm		CTC-1140761	72.39
	2254532		P-UB-10	110 mm	170 mm	CTC-2344442	202.04
BWY1-UP; TBA1-UP; WDE1-UP							
	2742456		Bushing	110 mm		CTC-1140762	67.76
	2742456		P-UB-10	110 mm	160 mm	CTC-2742460	223.74
	2742459		Bushing	110 mm		CTC-1140761	72.39
	2742459		P-UB-10	110 mm	170 mm	CTC-2742462	227.79
COUNTERWEIGHT							
BWY1-UP; TAJ1-UP; TBA1-UP; WDE1-UP							
	2369769		P-UB-10	3	4-3/4	CTC-2369769K	84.92
STICK							
BWY1-UP; ELS1-UP; GCL1-UP; TAJ1-UP; TBA1-UP; WDE1-UP							
	2254526		Bushing	130 mm		CTC-1140763	69.15
	2254526		P-UB-10	130 mm	190 mm	CTC-2254646	272.05
BWY1-UP; TAJ1-UP; TBA1-UP; WDE1-UP							
	2426839		Bushing	130 mm		CTC-1140763	69.15
	2426839		P-UB-10	130 mm	190 mm	CTC-2254646	272.05



REPLACEMENT KITS FOR CATERPILLAR® EQUIPMENT

Excavators							
APPLICATION	CYL #	Misc-Parts, Instructions, etc.	CODE	ROD	BORE	KIT #	List \$
MODEL 345C							
STICK							
BWY1-UP; TBA1-UP; WDE1-UP							
2742453			Bushing	130 mm		CTC-1140763	69.15
2742453			P-UB-10	130 mm	190 mm	CTC-2742461	368.60
MODEL 345C L							
BOOM							
BWY1-UP; DHP1-UP; ELS1-UP; ESD1-UP; FPC1-UP; GCL1-UP; GJR1-UP; GPH1-UP; LYS1-UP; PJW1-UP; S5M1-UP; TBA1-UP; TDG1-UP; WDE1-UP							
2254523			Bushing	110 mm		CTC-1140762	67.76
2254523			P-UB-10	110 mm	160 mm	CTC-2254625	228.21
BWY1-UP; DHP1-UP; GJR1-UP; TBA1-UP; WDE1-UP							
2668087			Bushing	110 mm		CTC-1140762	67.76
2668087			P-UB-10	110 mm	160 mm	CTC-2742460	223.74
BUCKET							
BWY1-UP; DHP1-UP; ELS1-UP; ESD1-UP; ESD1-UP; FPC1-UP; GCL1-UP; GJR1-UP; GPH1-UP; LYS1-UP; PJW1-UP; PJW1-UP; S5M1-UP; TBA1-UP; TDG1-UP; TDG1-UP; WDE1-UP							
2254529			Bushing	110 mm		CTC-1140762	67.76
2254529			P-UB-10	110 mm	160 mm	CTC-2254625	228.21
BWY1-UP; DHP1-UP; ELS1-UP; ESD1-UP; GCL1-UP; GJR1-UP; GPH1-UP; LYS1-UP; PJW1-UP; S5M1-UP; TBA1-UP; TDG1-UP; WDE1-UP							
2254532			Bushing	110 mm		CTC-1140761	72.39
2254532			P-UB-10	110 mm	170 mm	CTC-2344442	202.04
BWY1-UP; DHP1-UP; GJR1-UP; TBA1-UP; WDE1-UP							
2742456			Bushing	110 mm		CTC-1140762	67.76
2742456			P-UB-10	110 mm	160 mm	CTC-2742460	223.74
2742459			Bushing	110 mm		CTC-1140761	72.39
2742459			P-UB-10	110 mm	170 mm	CTC-2742462	227.79
COUNTERWEIGHT							
BWY1-UP; DHP1-UP; ESD1-UP; FPC1-UP; GJR1-UP; PJW1-UP; TBA1-UP; TDG1-UP; WDE1-UP							
2369769			P-UB-10	3	4-3/4	CTC-2369769K	84.92
STICK							
BWY1-UP; DHP1-UP; ELS1-UP; ESD1-UP; FPC1-UP; GCL1-UP; GJR1-UP; GPH1-UP; LYS1-UP; PJW1-UP; S5M1-UP; TBA1-UP; TDG1-UP; WDE1-UP							
2254526			Bushing	130 mm		CTC-1140763	69.15
2254526			P-UB-10	130 mm	190 mm	CTC-2254646	272.05
BWY1-UP; DHP1-UP; ESD1-UP; GJR1-UP; PJW1-UP; S5M1-UP; TBA1-UP; TDG1-UP; WDE1-UP							
2426839			Bushing	130 mm		CTC-1140763	69.15
2426839			P-UB-10	130 mm	190 mm	CTC-2254646	272.05
BWY1-UP; DHP1-UP; GJR1-UP; TBA1-UP; WDE1-UP							
2742453			Bushing	130 mm		CTC-1140763	69.15
2742453			P-UB-10	130 mm	190 mm	CTC-2742461	368.60
MODEL 350, 350L							
BOOM							
411515			P-UB-10	110 mm	170 mm	CTC-1163649	318.56
411515			P-UB-10	110 mm	170 mm	CTC-1680759	338.96
BUCKET							
411726			P-UB-10	110 mm	160 mm	CTC-0876654	271.50
413792			P-UB-10	130 mm	180 mm	CTC-0875407	336.78
7Y5100			P-UB-10	85 mm	130 mm	CTC-7Y5145	226.08

CATERPILLAR®



REPLACEMENT KITS FOR CATERPILLAR® EQUIPMENT

Excavators							
APPLICATION	CYL #	Misc-Parts, Instructions, etc.	CODE	ROD	BORE	KIT #	List \$
MODEL 350, 350L							
LIFT							
	6E3529		P-UB-10	2-1/2	4	CTC-710968	122.31
STICK							
	0875375		P-UB-10	130 mm	180 mm	CTC-0875407	336.78
MODEL 365, 365B							
COUNTERWEIGHT							
	1505913		P-UB-10	90 mm	130 mm	CTC-1184175	249.77
MODEL 375							
BOOM							
	1140596		P-UB-10	140 mm	200 mm	CTC-1560626	552.29
	6E0018		P-UB-10	140 mm	200 mm	CTC-1560626	552.29
BUCKET							
	6E0020		P-UB-10	150 mm	220 mm	CTC-518893	675.88
	6E0021		P-UB-10	140 mm	200 mm	CTC-1560626	552.29
LIFT							
	6E3529		P-UB-10	2-1/2	4	CTC-710968	122.31
STICK							
	6E0019		P-UB-10	150 mm	220 mm	CTC-518893	675.88
MODEL 375L							
BOOM							
	6E0018		P-UB-10	140 mm	200 mm	CTC-1560626	552.29
BUCKET							
	411726		P-UB-10	110 mm	160 mm	CTC-0876654	271.50
LIFT							
	6E3529		P-UB-10	2-1/2	4	CTC-710968	122.31
STICK							
	6E0019		P-UB-10	150 mm	220 mm	CTC-518893	675.88
MODEL E110							
BOOM							
	0936151		P-UB-15	70 mm	110 mm	CTC-938385	179.67
BUCKET							
	0936181		P-UB-15	65 mm	110 mm	CTC-938390	286.26
STICK							
	0936167		P-UB-15	80 mm	120 mm	CTC-938388	291.92
MODEL E110B							
BOOM							
	0995402		P-UB-14	70 mm	100 mm	CTC-0995401	196.39
	0995403		P-UB-14	70 mm	100 mm	CTC-0995401	196.39
STICK							
	0855801		P-UB-14	75 mm	110 mm	CTC-995310	229.97
	0856657		P-UB-14	75 mm	100 mm	CTC-0860174	228.63
	0861937		P-UB-14	75 mm	110 mm	CTC-995310	229.97
	0995369		P-UB-14	75 mm	110 mm	CTC-995310	229.97
MODEL E120							
BOOM LH							
	0958487		P-UB-10	75 mm	110 mm	CTC-0967786	298.73



REPLACEMENT KITS FOR CATERPILLAR® EQUIPMENT

Excavators							
APPLICATION	CYL #	Misc-Parts, Instructions, etc.	CODE	ROD	BORE	KIT #	List \$
MODEL E120							
BOOM RH	0958486		P-UB-10	75 mm	110 mm	CTC-0967786	298.73
BUCKET	0938997		P-UB-10	65 mm	100 mm	CTC-0967625	285.19
STICK	0938966		P-UB-10	80 mm	120 mm	CTC-967799	287.90
MODEL E120B							
BOOM LH	0990662		P-UB-14	75 mm	110 mm	CTC-995310	229.97
BOOM RH	0990663		P-UB-14	75 mm	110 mm	CTC-995310	229.97
BUCKET	0990701		P-UB-14	65 mm	100 mm	CTC-995312	249.27
STICK	7NF01890-03529						
	0861868	7NF01890-03529	P-UB-14	80 mm	120 mm	CTC-995311	245.43
	7NF03530-						
	0855740	7NF03530-	P-UB-14	80 mm	120 mm	CTC-995311	245.43
	7NF1-01889						
	0990682	7NF1-01889	P-UB-14	80 mm	120 mm	CTC-995311	245.43
TELESCOPIC STICK	0856657		P-UB-14	75 mm	100 mm	CTC-0860174	228.63
MODEL E180, EL180							
BOOM LH	0941911		P-UB-10	85 mm	125 mm	CTC-940691	273.02
BOOM RH	0941926		P-UB-10	85 mm	125 mm	CTC-940691	273.02
BUCKET	0941946		P-UB-10	85 mm	125 mm	CTC-940691	273.02
STICK	0941929		P-UB-10	100 mm	140 mm	CTC-941910	325.87
MODEL E200B, EL200B							
BOOM LH	0967907		P-UB-10	85 mm	120 mm	CTC-964395	329.01
BOOM RH	0967908		P-UB-10	85 mm	120 mm	CTC-964395	329.01
BUCKET	0967909		P-UB-10	75 mm	115 mm	CTC-966457	305.11
BUCKET LONG REACH	0993713		P-UB-14	65 mm	100 mm	CTC-995312	249.27
STICK	0967910		P-UB-10	100 mm	140 mm	CTC-1890282	245.38
STICK LONG REACH	0993688		P-UB-10	95 mm	130 mm	CTC-964396	363.00
MODEL E240, EL240							
BOOM LH	0941549		P-UB-14	90 mm	140 mm	CTC-939941	258.95

CATERPILLAR®



REPLACEMENT KITS FOR CATERPILLAR® EQUIPMENT

Excavators							
APPLICATION	CYL #	Misc-Parts, Instructions, etc.	CODE	ROD	BORE	KIT #	List \$
MODEL E240, EL240							
BOOM RH	0941550		P-UB-14	90 mm	140 mm	CTC-939941	258.95
BUCKET	0962391		P-UB-14	90 mm	140 mm	CTC-939941	258.95
STICK	0941406		P-UB-14	100 mm	150 mm	CTC-942697	216.56
MODEL E240B, EL240B							
BOOM	1R8082		P-UB-14	90 mm	140 mm	CTC-939941	258.95
BOOM LH	0996240		P-UB-14	90 mm	140 mm	CTC-939941	258.95
BOOM RH	0996241		P-UB-14	90 mm	140 mm	CTC-939941	258.95
BUCKET	0996233		P-UB-14	90 mm	140 mm	CTC-939941	258.95
	1R5580		P-UB-14	65 mm	100 mm	CTC-995312	249.27
STICK	0996237		P-UB-14	100 mm	150 mm	CTC-942697	216.56
MODEL E300, EL300							
BOOM LH	0946493		P-UB-14	100 mm	150 mm	CTC-942697	216.56
BOOM RH	0946494		P-UB-14	100 mm	150 mm	CTC-942697	216.56
BUCKET	0962932		P-UB-14	100 mm	150 mm	CTC-942697	216.56
STICK	0962920		P-UB-14	110 mm	160 mm	CTC-942698	329.70
MODEL E300B, EL300B							
BOOM	1R7823		P-UB-10	100 mm	140 mm	CTC-1890282	245.38
BOOM LH	0995577		P-UB-10	100 mm	140 mm	CTC-1890282	245.38
BOOM RH	0995578		P-UB-10	100 mm	140 mm	CTC-1890282	245.38
MODEL M320							
BOOM	1283203		P-UB-10	95 mm	130 mm	CTC-7Y5147	252.83
BUCKET	0875633		P-UB-10	85 mm	120 mm	CTC-0875394	218.89
	0875633		P-UB-10	85 mm	120 mm	CTC-1184131	211.36
STICK	1279242		P-UB-10	100 mm	140 mm	CTC-0875387	289.01
	1386696		P-UB-10	85 mm	120 mm	CTC-1184131	211.36



REPLACEMENT KITS FOR CATERPILLAR® EQUIPMENT

Front-Shovel Excavators							
APPLICATION	CYL #	Misc-Parts, Instructions, etc.	CODE	ROD	BORE	KIT #	List \$
MODEL 5080							
BOOM							
	4I3915		P-UB-10	130 mm	180 mm	CTC-0875407	336.78
STICK							
	6E4272		P-UB-10	150 mm	220 mm	CTC-518893	675.88
MODEL 5110							
BUCKET							
	6E0020		P-UB-10	150 mm	220 mm	CTC-518893	675.88
MODEL 5230, 5230B							
BUCKET							
	6E6435		P-UB-10	3-1/2	7-1/4	CTC-1309483	264.19
Integrated Toolcarriers							
APPLICATION	CYL #	Misc-Parts, Instructions, etc.	CODE	ROD	BORE	KIT #	List \$
MODEL IT12							
LIFT							
	4T8579		I-U-3	3/4	1-1/4	CTC-1791715	12.78
	4T8580		P-UB-10	2	3-3/4	CTC-7X2787	76.39
M.P. BUCKET							
	8J5391		P-UB-10	1-1/2	3-1/2	CTC-7X2752	80.70
STEERING							
	1U4666		P-UB-10	1-1/2	2-3/4	CTC-7X2736	106.91
	9T5153		P-UB-10	1-1/2	2-3/4	CTC-7X2736	106.91
	9T5729		I-O-3	3/4	1-1/4	CTC-1791749	4.55
TILT							
	4T8581		P-UB-10	1-3/4	3-1/4	CTC-7X2764	54.01
	9T5151		P-UB-10	2	3-1/2	CTC-7X2783	87.11
	9T5489		P-UB-10	1-3/4	3-1/4	CTC-7X2764	54.01
MODEL IT12B							
LIFT							
	6E6398		P-UB-10	2-1/4	3-1/2	CTC-1859503	116.35
	9T5152		P-UB-10	2-1/4	4	CTC-1859527	96.96
PIN PULLER							
	9T5729		I-O-3	3/4	1-1/4	CTC-1791749	4.55
STEERING							
	4T8579		I-U-3	3/4	1-1/4	CTC-1791715	12.78
	9T5729		I-O-3	3/4	1-1/4	CTC-1791749	4.55
	9T7209	Head# 6E4940	P-UB-10	1-1/2	2-3/4	CTC-1361599	90.09
	9T7209	Head# 9T2542	P-UB-10	1-1/2	2-3/4	CTC-7X2736	106.91
	9T7210	Head# 6E4940	P-UB-10	1-1/2	2-3/4	CTC-1361599	90.09
	9T7210	Head# 9T2542	P-UB-10	1-1/2	2-3/4	CTC-7X2736	106.91
STEERING LH							
	6E5900	Head# 1515349	P-UB-10	1-3/4	2-3/4	CTC-1539053	127.54
	6E5900	Head# 6E4941	P-UB-10	1-3/4	2-3/4	CTC-1857024	46.55
	6E5973		P-UB-10	1-1/2	2-3/4	CTC-1361599	90.09
	9T7209	Head# 6E4940	P-UB-10	1-1/2	2-3/4	CTC-1361599	90.09
	9T7209	Head# 9T2542	P-UB-10	1-1/2	2-3/4	CTC-7X2736	106.91

CATERPILLAR®



REPLACEMENT KITS FOR CATERPILLAR® EQUIPMENT

Integrated Toolcarriers							
APPLICATION	CYL #	Misc-Parts, Instructions, etc.	CODE	ROD	BORE	KIT #	List \$
MODEL IT12B							
STEERING RH							
	6E5972	Head# 1515349	P-UB-10	1-3/4	2-3/4	CTC-1539053	127.54
	6E5972	Head# 6E4941	P-UB-10	1-3/4	2-3/4	CTC-1857024	46.55
	6E5985		P-UB-10	1-1/2	2-3/4	CTC-1361599	90.09
TILT							
	9T5151		P-UB-10	2	3-1/2	CTC-1857674	97.71
MODEL IT12F							
LIFT							
	6E6398		P-UB-10	2-1/4	3-1/2	CTC-1859503	116.35
	9T5152		P-UB-10	2-1/4	4	CTC-1859527	96.96
STEERING							
	4T8579		I-U-3	3/4	1-1/4	CTC-1791715	12.78
	9T5729		I-O-3	3/4	1-1/4	CTC-1791749	4.55
	9T7209	Head# 6E4940	P-UB-10	1-1/2	2-3/4	CTC-1361599	90.09
	9T7209	Head# 9T2542	P-UB-10	1-1/2	2-3/4	CTC-7X2736	106.91
	9T7210	Head# 6E4940	P-UB-10	1-1/2	2-3/4	CTC-1361599	90.09
	9T7210	Head# 9T2542	P-UB-10	1-1/2	2-3/4	CTC-7X2736	106.91
STEERING LH							
	6E5900	Head# 1515349	P-UB-10	1-3/4	2-3/4	CTC-1539053	127.54
	6E5900	Head# 6E4941	P-UB-10	1-3/4	2-3/4	CTC-1857024	46.55
	6E5973		P-UB-10	1-1/2	2-3/4	CTC-1361599	90.09
STEERING RH							
	6E5972	Head# 1515349	P-UB-10	1-3/4	2-3/4	CTC-1539053	127.54
	6E5972	Head# 6E4941	P-UB-10	1-3/4	2-3/4	CTC-1857024	46.55
	6E5985		P-UB-10	1-1/2	2-3/4	CTC-1361599	90.09
TILT							
	9T5151		P-UB-10	2	3-1/2	CTC-1857674	97.71
MODEL IT14B							
LIFT							
	9T5152		P-UB-10	2-1/4	4	CTC-1859527	96.96
PIN PULLER							
	9T5729		I-O-3	3/4	1-1/4	CTC-1791749	4.55
STEERING							
	4T8579		I-U-3	3/4	1-1/4	CTC-1791715	12.78
	9T5729		I-O-3	3/4	1-1/4	CTC-1791749	4.55
	9T7209	Head# 6E4940	P-UB-10	1-1/2	2-3/4	CTC-1361599	90.09
	9T7209	Head# 9T2542	P-UB-10	1-1/2	2-3/4	CTC-7X2736	106.91
	9T7210	Head# 6E4940	P-UB-10	1-1/2	2-3/4	CTC-1361599	90.09
	9T7210	Head# 9T2542	P-UB-10	1-1/2	2-3/4	CTC-7X2736	106.91
STEERING LH							
	6E5973		P-UB-10	1-1/2	2-3/4	CTC-1361599	90.09
	9T7209	Head# 6E4940	P-UB-10	1-1/2	2-3/4	CTC-1361599	90.09
	9T7209	Head# 9T2542	P-UB-10	1-1/2	2-3/4	CTC-7X2736	106.91
STEERING RH							
	6E5985		P-UB-10	1-1/2	2-3/4	CTC-1361599	90.09
TILT							
	9T5151		P-UB-10	2	3-1/2	CTC-1857674	97.71



REPLACEMENT KITS FOR CATERPILLAR® EQUIPMENT

Integrated Toolcarriers							
APPLICATION	CYL #	Misc-Parts, Instructions, etc.	CODE	ROD	BORE	KIT #	List \$
MODEL IT14C							
TILT							
	9T5151		P-UB-10	2	3-1/2	CTC-7X2783	87.11
MODEL IT14F							
LIFT							
	6E6398		P-UB-10	2-1/4	3-1/2	CTC-1859503	116.35
STEERING							
	4T8579		I-U-3	3/4	1-1/4	CTC-1791715	12.78
	9T5729		I-O-3	3/4	1-1/4	CTC-1791749	4.55
STEERING LH							
	6E5900	Head# 1515349	P-UB-10	1-3/4	2-3/4	CTC-1539053	127.54
	6E5900	Head# 6E4941	P-UB-10	1-3/4	2-3/4	CTC-1857024	46.55
STEERING RH							
	6E5972	Head# 1515349	P-UB-10	1-3/4	2-3/4	CTC-1539053	127.54
	6E5972	Head# 6E4941	P-UB-10	1-3/4	2-3/4	CTC-1857024	46.55
MODEL IT14G							
FK							
	1491381		P-UB-10	2	3-1/2	CTC-1857674	97.71
LIFT							
	1116244		P-UB-10	2-1/4	3-1/2	CTC-1859503	116.35
	1314401		P-UB-10	2-1/4	3-1/2	CTC-1859503	116.35
	1314402		P-UB-10	2-1/4	3-1/2	CTC-1859503	116.35
STEERING							
	1044187		P-UB-10	1-1/2	2-1/2	CTC-1856601	43.80
	4T8579		I-U-3	3/4	1-1/4	CTC-1791715	12.78
	9T8823		I-O-3	1	2	CTC-9T0418	70.20
MODEL IT18							
LIFT							
	4T5544		I-O-3	1	2	CTC-9T0418	70.20
	4T8648	Head# 3G2956	P-UB-10	2-1/4	4-1/4	CTC-1859507	93.98
	4T8648	Head# 9T7349	P-UB-10	2-1/4	4-1/4	CTC-1859517	112.92
M.P. BUCKET TILT							
	4T4666		P-UB-10	2-1/2	4	CTC-1864338	69.04
PIN COUPLER							
	9T2352		I-O-3	1	2	CTC-9T0418	70.20
PIN PULLER							
	6E5392		I-O-3	1	2	CTC-9T0418	70.20
	6E5393		I-O-3	1	2	CTC-9T0418	70.20
SPECIAL APPLICATION							
	6E0906		I-O-3	1	2	CTC-9T0418	70.20
STEERING							
	1U3322		P-UB-10	1-1/2	3	CTC-1856587	51.38
	4T9981		I-O-3	1	2	CTC-9T0418	70.20
	6E0906		I-O-3	1	2	CTC-9T0418	70.20
	6E5392		I-O-3	1	2	CTC-9T0418	70.20
	9T2352		I-O-3	1	2	CTC-9T0418	70.20
TILT							
	4T4666		P-UB-10	2-1/2	4	CTC-1864338	69.04

CATERPILLAR®



REPLACEMENT KITS FOR CATERPILLAR® EQUIPMENT

Integrated Toolcarriers							
APPLICATION	CYL #	Misc-Parts, Instructions, etc.	CODE	ROD	BORE	KIT #	List \$
MODEL IT18B							
LIFT							
	4T5544		I-O-3	1	2	CTC-9T0418	70.20
	4T9981		I-O-3	1	2	CTC-9T0418	70.20
	6E0906		I-O-3	1	2	CTC-9T0418	70.20
	6E5392		I-O-3	1	2	CTC-9T0418	70.20
	6E5393		I-O-3	1	2	CTC-9T0418	70.20
	9T2352		I-O-3	1	2	CTC-9T0418	70.20
	9T5030	Head# 9T5031	P-UB-10	2-1/2	4-3/4	CTC-1328811	136.56
PIN COUPLER							
	4T9981		I-O-3	1	2	CTC-9T0418	70.20
	6E5392		I-O-3	1	2	CTC-9T0418	70.20
	6E5393		I-O-3	1	2	CTC-9T0418	70.20
	9T2352		I-O-3	1	2	CTC-9T0418	70.20
	9T8485		I-O-3	1	2	CTC-9T0418	70.20
SPECIAL APPLICATION							
	4T5544		I-O-3	1	2	CTC-9T0418	70.20
	6E0906		I-O-3	1	2	CTC-9T0418	70.20
STEERING							
	1U3322		P-UB-10	1-1/2	3	CTC-1856587	51.38
	9T8485		I-O-3	1	2	CTC-9T0418	70.20
TILT							
	9T5267		P-UB-10	2	4	CTC-1857688	58.90
MODEL IT18F							
LIFT							
	1007020	Head# 1206679	P-UB-10	2-1/2	4-3/4	CTC-1361131	121.12
	1007020	Head# 9T3609	P-UB-10	2-1/2	4-3/4	CTC-1864381	131.42
	1341379		P-UB-10	2-1/2	4-3/4	CTC-1361131	121.12
	9T7044		P-UB-10	2-1/2	4-3/4	CTC-1864381	131.42
	9T8823		I-O-3	1	2	CTC-9T0418	70.20
PIN PULLER							
	6E5393		I-O-3	1	2	CTC-9T0418	70.20
STEERING							
	6E1114		I-O-3	1	2	CTC-9T0418	70.20
	9T2637		P-UB-10	1-1/2	2-3/4	CTC-1361599	90.09
TILT							
	1341380		P-UB-10	2	4	CTC-1857688	58.90
	9T7026		P-UB-10	2	4	CTC-1857688	58.90
MODEL IT24F							
LIFT							
	1007020	Head# 1206679	P-UB-10	2-1/2	4-3/4	CTC-1361131	121.12
	1007020	Head# 9T3609	P-UB-10	2-1/2	4-3/4	CTC-1864381	131.42
	1341379		P-UB-10	2-1/2	4-3/4	CTC-1361131	121.12
	1342327		P-UB-10	2-1/4	4	CTC-1546526	127.50
	9T3937		P-UB-10	2-1/4	4	CTC-1546526	127.50
	9T8823		I-O-3	1	2	CTC-9T0418	70.20
STEERING							
	9T2637		P-UB-10	1-1/2	2-3/4	CTC-1361599	90.09



REPLACEMENT KITS FOR CATERPILLAR® EQUIPMENT

Integrated Toolcarriers							
APPLICATION	CYL #	Misc-Parts, Instructions, etc.	CODE	ROD	BORE	KIT #	List \$
MODEL IT24F							
TILT							
	1107845	Head# 1206679	P-UB-10	2-1/2	4-1/2	CTC-1113300	115.52
	1107845	Head# 9T3609	P-UB-10	2-1/2	4-1/2	CTC-1469860	136.41
	1262492		P-UB-10	2	4	CTC-1113302	100.62
	1262492		P-UB-10	2	4	CTC-1857688	58.90
	1341380		P-UB-10	2	4	CTC-1857688	58.90
	1341381		P-UB-10	2	4	CTC-1857688	58.90
	1342671		P-UB-10	2-1/2	4-1/2	CTC-1113300	115.52
	6E1114		I-O-3	1	2	CTC-9T0418	70.20
	6E4651	Head# 1206679	P-UB-10	2-1/2	4-1/2	CTC-1113300	115.52
	6E4651	Head# 9T3609	P-UB-10	2-1/2	4-1/2	CTC-1469860	136.41
	9T7026		P-UB-10	2	4	CTC-1857688	58.90
MODEL IT28							
LIFT							
	3G2991		P-UB-10	2-1/2	4-3/4	CTC-1328811	136.56
PIN PULLER							
	6E5392		I-O-3	1	2	CTC-9T0418	70.20
	6E5393		I-O-3	1	2	CTC-9T0418	70.20
	9T2352		I-O-3	1	2	CTC-9T0418	70.20
SPECIAL APPLICATION							
	4T5544		I-O-3	1	2	CTC-9T0418	70.20
	6E0906		I-O-3	1	2	CTC-9T0418	70.20
STEERING							
	3G3501		P-UB-10	1-1/2	3	CTC-1372530	76.40
	4T9981		I-O-3	1	2	CTC-9T0418	70.20
	6E0906		I-O-3	1	2	CTC-9T0418	70.20
	6E5392		I-O-3	1	2	CTC-9T0418	70.20
	9T2352		I-O-3	1	2	CTC-9T0418	70.20
TILT							
	4T5544		I-O-3	1	2	CTC-9T0418	70.20
	4T5545	Head# 8J8431	P-UB-10	2-1/2	4-1/4	CTC-1864336	76.66
	4T5545	Head# 9T6548	P-UB-10	2-1/2	4-1/4	CTC-1864373	86.80
TILT MP, BUCKET							
	4T5545	Head# 8J8431	P-UB-10	2-1/2	4-1/4	CTC-1864336	76.66
	4T5545	Head# 9T6548	P-UB-10	2-1/2	4-1/4	CTC-1864373	86.80
MODEL IT28B							
LIFT							
	3G2991		P-UB-10	2-1/2	4-3/4	CTC-1328811	136.56
	4T8648	Head# 3G2956	P-UB-10	2-1/4	4-1/4	CTC-1859507	93.98
	4T8648	Head# 9T7349	P-UB-10	2-1/4	4-1/4	CTC-1859517	112.92
PIN COUPLER							
	4T9981		I-O-3	1	2	CTC-9T0418	70.20
	6E5392		I-O-3	1	2	CTC-9T0418	70.20
	9T2352		I-O-3	1	2	CTC-9T0418	70.20
	9T8485		I-O-3	1	2	CTC-9T0418	70.20

CATERPILLAR®



REPLACEMENT KITS FOR CATERPILLAR® EQUIPMENT

Integrated Toolcarriers							
APPLICATION	CYL #	Misc-Parts, Instructions, etc.	CODE	ROD	BORE	KIT #	List \$
MODEL IT28B							
SPECIAL APPLICATION							
	4T5544		I-O-3	1	2	CTC-9T0418	70.20
	6E0906		I-O-3	1	2	CTC-9T0418	70.20
STEERING							
	1U3322		P-UB-10	1-1/2	3	CTC-1856587	51.38
	3G3501		P-UB-10	1-1/2	3	CTC-7X2751	54.17
	3G5110		P-UB-10	1-3/4	3-1/2	CTC-7X2762	84.64
	3G5110		P-UB-10	1-3/4	3-1/2	CTC-7X2784	47.66
	4T9981		I-O-3	1	2	CTC-9T0418	70.20
	6E0906		I-O-3	1	2	CTC-9T0418	70.20
	6E5392		I-O-3	1	2	CTC-9T0418	70.20
	6E5393		I-O-3	1	2	CTC-9T0418	70.20
	9T2352		I-O-3	1	2	CTC-9T0418	70.20
	9T8485		I-O-3	1	2	CTC-9T0418	70.20
TILT							
	3G6571		P-UB-10	2-1/2	4-3/4	CTC-1328811	136.56
	4T5544		I-O-3	1	2	CTC-9T0418	70.20
	4T5545	Head# 8J8431	P-UB-10	2-1/2	4-1/4	CTC-1864336	76.66
	4T5545	Head# 9T6548	P-UB-10	2-1/2	4-1/4	CTC-1864373	86.80
TILT MP, BUCKET							
	4T5545	Head# 8J8431	P-UB-10	2-1/2	4-1/4	CTC-1864336	76.66
	4T5545	Head# 9T6548	P-UB-10	2-1/2	4-1/4	CTC-1864373	86.80
MODEL IT28F							
LIFT							
	1341384		P-UB-10	2-1/2	4-3/4	CTC-1361131	121.12
	9T6788	Head# 1206679	P-UB-10	2-1/2	4-3/4	CTC-1361131	121.12
	9T6788	Head# 9T3609	P-UB-10	2-1/2	4-3/4	CTC-1864381	131.42
	9T8823		I-O-3	1	2	CTC-9T0418	70.20
PIN PULLER							
	6E5393		I-O-3	1	2	CTC-9T0418	70.20
STEERING							
	6E1114		I-O-3	1	2	CTC-9T0418	70.20
	9T6646		P-UB-10	1-1/2	2-3/4	CTC-1361599	90.09
TILT							
	1341385		P-UB-10	2	4	CTC-1857688	58.90
	9T6929		P-UB-10	2	4	CTC-1857688	58.90
MODEL IT28G							
LIFT							
	1191060		P-UB-10	2-1/2	4-3/4	CTC-1361131	121.12
	6E1114		I-O-3	1	2	CTC-9T0418	70.20
	9T8823		I-O-3	1	2	CTC-9T0418	70.20
STEERING LH							
	1250374		P-UB-10	1-1/2	2-3/4	CTC-1361599	90.09
STEERING RH							
	1250373		P-UB-10	1-1/2	2-3/4	CTC-1361599	90.09



REPLACEMENT KITS FOR CATERPILLAR® EQUIPMENT

Integrated Toolcarriers							
APPLICATION	CYL #	Misc-Parts, Instructions, etc.	CODE	ROD	BORE	KIT #	List \$
MODEL IT28G							
TILT							
	1191852		P-UB-10	2	4	CTC-1857688	58.90
	1273020		P-UB-10	2	4	CTC-1857688	58.90
MODEL IT38F							
LIFT							
	1148131		P-UB-10	3	4-3/4	CTC-1915030	137.05
STEERING							
	1050094		P-UB-10	1-3/4	3	CTC-1857025	39.25
TILT							
	1156963		P-UB-10	2-3/4	4-1/2	CTC-1933117	94.37
MODEL IT38G							
LIFT							
	1148131		P-UB-10	3	4-3/4	CTC-1570288	145.81
STEERING							
	1050094		P-UB-10	1-3/4	3	CTC-7X2825	42.17
	1393312		P-UB-10	1-3/4	3	CTC-7X2825	42.17
MODEL IT62G							
LIFT RH							
	1188296		P-UB-10	3	6	CTC-7X2698	157.60
	1250024		P-UB-10	3	6	CTC-7X2698	157.60
STEERING							
	1188288		P-UB-10	1-3/4	3-1/2	CTC-7X2784	47.66
TILT							
	1349397		P-UB-10	3	5-1/4	CTC-3E3293	150.34
Landfill Compactors							
APPLICATION	CYL #	Misc-Parts, Instructions, etc.	CODE	ROD	BORE	KIT #	List \$
MODEL 816							
LIFT							
	1U2088		P-UB-10	2-1/2	4-3/4	CTC-7X2660	151.93
	4J9233		P-V-10	2	4-1/2	CTC-7X2770	82.84
STEERING							
	4T1574		P-UB-10	2	4	CTC-7X2789	86.29
STEERING LH							
	7J9356		P-UB-10	2	4	CTC-7X2755	115.58
STEERING RH							
	7J9355		P-UB-10	2	4	CTC-7X2755	115.58
MODEL 816B							
DOZER							
	1U2088		P-UB-10	2-1/2	4-3/4	CTC-1328811	136.56
DOZER LIFT							
	1U2088		P-UB-10	2-1/2	4-3/4	CTC-7X2660	151.93
STEERING							
	4T1574		P-UB-10	2	4	CTC-1328816	78.46
	6E5024		P-UB-10	2	4	CTC-1113302	100.62
STEERING LH							
	7J9356		P-UB-10	2	4	CTC-7X2755	115.58

CATERPILLAR®



REPLACEMENT KITS FOR CATERPILLAR® EQUIPMENT

Landfill Compactors							
APPLICATION	CYL #	Misc-Parts, Instructions, etc.	CODE	ROD	BORE	KIT #	List \$
MODEL 816F							
DOZER							
	1U2088		P-UB-10	2-1/2	4-3/4	CTC-1328811	136.56
STEERING							
	4T1574		P-UB-10	2	4	CTC-1328816	78.46
	6E5024		P-UB-10	2	4	CTC-1113302	100.62
MODEL 826B							
LIFT							
	7K9401		P-UB-10	2-1/4	5	CTC-7X2729	137.33
	8J2650		P-UB-10	2	4-1/2	CTC-7X2768	75.01
	9J7111		P-UB-10	2-1/2	5-1/2	CTC-7X2653	137.42
STEERING							
	7J9718		P-UB-10	2-1/4	5	CTC-7X2729	137.33
STEERING LH							
	9J7087		P-UB-10	2-1/4	5	CTC-7X2729	137.33
STEERING RH							
	9J7086		P-UB-10	2-1/4	5	CTC-7X2729	137.33
MODEL 826C							
LIFT							
	8J2650		P-UB-10	2	4-1/2	CTC-7X2768	75.01
	9J7111		P-UB-10	2-1/2	5-1/2	CTC-7X2653	137.42
STEERING							
	9J7086		P-UB-10	2-1/4	5	CTC-9X6392	135.36
	9J7087		P-UB-10	2-1/4	5	CTC-9X6392	135.36
MODEL 826G							
DOZER							
	1164842		P-UB-10	3	4-3/4	CTC-1570288	145.81
STEERING							
	1175151		P-UB-10	2-1/2	4-1/2	CTC-1113300	115.52
MODEL 836, 836C							
LIFT							
	6J1272		P-V-10	2-1/2	6-1/2	CTC-7X2676	92.56
STEERING							
	9J8165		P-UB-10	2-1/4	5	CTC-9X6392	135.36
Motor Graders							
APPLICATION	CYL #	Misc-Parts, Instructions, etc.	CODE	ROD	BORE	KIT #	List \$
MODEL 12							
STEERING							
	4J4115		P-UB-10	1-1/2	4	CTC-7X2738	73.99
MODEL 12E							
STEERING							
	4J4115		P-UB-10	1-1/2	4	CTC-7X2738	73.99
MODEL 12F							
STEERING							
	4J4115		P-UB-10	1-1/2	4	CTC-7X2738	73.99



REPLACEMENT KITS FOR CATERPILLAR® EQUIPMENT

Motor Graders							
APPLICATION	CYL #	Misc-Parts, Instructions, etc.	CODE	ROD	BORE	KIT #	List \$
MODEL 12G							
ARTICULATION							
	8J0546		P-UB-10	1-3/4	3	CTC-7X2791	74.94
	9T2453		P-UB-10	1-3/4	3	CTC-7X2825	42.17
	9T8784		P-UB-10	1-3/4	3	CTC-7X2825	42.17
BACKHOE STICK/BLADE SHIFT							
	8J0028		P-UB-10	1-3/4	3	CTC-7X2791	74.94
BLADE							
	3G5223		P-UB-10	2	3-1/4	CTC-7X2767	54.31
	8J6380		P-UB-10	2	3-1/4	CTC-7X2767	54.31
	9T2472		P-UB-10	2	3	CTC-7X2753	50.05
	9T2472		P-UB-10	2	3	CTC-7X2760	54.39
BLADE TIP							
	6E1549		P-UB-10	1-1/2	2-3/4	CTC-1361599	90.09
	8J0024		P-UB-10	1-1/2	2-3/4	CTC-7X2749	49.96
	8J0024		P-UB-10	1-1/2	2-3/4	CTC-8T1402	41.92
	9J3466		P-UB-10	1-1/2	2-3/4	CTC-7X2749	49.96
	9T2461		P-UB-10	1-1/2	2-3/4	CTC-1361599	90.09
CENTER SHIFT							
	3G5224		P-UB-10	2	3-1/4	CTC-7X2767	54.31
	9T2549		P-UB-10	2	3	CTC-7X2760	54.39
CONVEYOR SWING							
	3G5224		P-UB-10	2	3-1/4	CTC-7X2767	54.31
	8J6367		P-UB-10	2	3-1/4	CTC-7X2767	54.31
	9T2549		P-UB-10	2	3	CTC-7X2760	54.39
RIPPER							
	1137754		P-UB-10	2	4	CTC-1328816	78.46
	8J1658		P-UB-10	2	4	CTC-1328816	78.46
SCARIFIER							
	3G1853		P-UB-10	1-3/4	3	CTC-7X2791	74.94
	8J7321		P-UB-10	1-1/2	3	CTC-7X2751	54.17
	9T2554		P-UB-10	1-3/4	3	CTC-7X2825	42.17
	9T6951		P-UB-10	1-3/4	3	CTC-7X2825	42.17
SIDESHIFT							
	1052094		P-UB-10	1-3/4	3	CTC-7X2825	42.17
	9T2483		P-UB-10	1-3/4	3	CTC-7X2825	42.17
STEERING LH							
	3G8070		P-UB-10	1-1/2	2-1/2	CTC-7X2739	47.83
	8J8820		P-UB-10	1-1/2	2-1/2	CTC-7X2739	47.83
	9T2395		P-UB-10	1-1/2	2-1/4	CTC-7X2826	34.46
STEERING RH							
	3G8069		P-UB-10	1-1/2	2-1/2	CTC-7X2739	47.83
	8J5538		P-UB-10	1-1/2	2-1/2	CTC-7X2739	47.83
	9T2393		P-UB-10	1-1/2	2-1/4	CTC-7X2826	34.46

CATERPILLAR®



REPLACEMENT KITS FOR CATERPILLAR® EQUIPMENT

Motor Graders							
APPLICATION	CYL #	Misc-Parts, Instructions, etc.	CODE	ROD	BORE	KIT #	List \$
MODEL 12G							
WHEEL LEAN							
	1219242		P-UB-10	2	3-1/2	CTC-7X2783	87.11
	3G4752		P-UB-10	1-1/2	3-1/2	CTC-7X2752	80.70
	8J5539		P-UB-10	1-1/2	3-1/2	CTC-7X2752	80.70
	9T2520		P-UB-10	1-1/2	3-1/2	CTC-1327058	87.86
MODEL 12H							
ARTICULATION							
	6E1560		P-UB-10	1-3/4	3	CTC-7X2825	42.17
	9T8784		P-UB-10	1-3/4	3	CTC-7X2825	42.17
BLADE							
	1324929		P-UB-10	2	3	CTC-7X2760	54.39
BLADE TIP							
	6E1549		P-UB-10	1-1/2	2-3/4	CTC-1361599	90.09
CONVEYOR SWING							
	6E1343		P-UB-10	2	3	CTC-7X2760	54.39
RIPPER							
	1137754		P-UB-10	2	4	CTC-1328816	78.46
SCARIFIER							
	9T2554		P-UB-10	1-3/4	3	CTC-7X2825	42.17
	9T6951		P-UB-10	1-3/4	3	CTC-7X2825	42.17
SIDESHIFT							
	1125575		P-UB-10	1-3/4	3	CTC-7X2825	42.17
STEERING LH							
	9T2395		P-UB-10	1-1/2	2-1/4	CTC-7X2826	34.46
STEERING RH							
	9T2393		P-UB-10	1-1/2	2-1/4	CTC-7X2826	34.46
WHEEL LEAN							
	1219242		P-UB-10	2	3-1/2	CTC-7X2783	87.11
	9T2520		P-UB-10	1-1/2	3-1/2	CTC-1327058	87.86
MODEL 14							
LIFT							
	3G5227		P-UB-10	2-1/4	3-3/4	CTC-7X2798	64.20
STEERING							
	4J4115		P-UB-10	1-1/2	4	CTC-7X2738	73.99
STEERING LH							
	3G7644		P-UB-10	1-1/2	2-3/4	CTC-7X2749	49.96
STEERING RH							
	3G7643		P-UB-10	1-1/2	2-3/4	CTC-7X2749	49.96
MODEL 14D, 140							
STEERING							
	4J4115		P-UB-10	1-1/2	4	CTC-7X2738	73.99
MODEL 14E							
ARTICULATION							
	8J6269		P-UB-10	2	3-1/2	CTC-7X2792	74.25
	9T2879		P-UB-10	2	3-1/2	CTC-7X2783	87.11



REPLACEMENT KITS FOR CATERPILLAR® EQUIPMENT

Motor Graders							
APPLICATION	CYL #	Misc-Parts, Instructions, etc.	CODE	ROD	BORE	KIT #	List \$
MODEL 14E							
BLADE SHIFT							
	4T0340		P-UB-10	2-1/2	4	CTC-7X2665	141.19
	8J6359		P-UB-10	2-1/4	3-3/4	CTC-7X2798	64.20
BLADE TIP							
	4T0379		P-UB-10	2	4	CTC-7X2789	86.29
CENTER SHIFT							
	3G5228		P-UB-10	2-1/4	3-3/4	CTC-7X2798	64.20
DRAWBAR TIP							
	8J6256		P-UB-10	1-1/2	3	CTC-7X2751	54.17
LIFT							
	3G5227		P-UB-10	2-1/4	3-3/4	CTC-7X2798	64.20
	8J6010		P-UB-10	2-1/4	3-3/4	CTC-7X2798	64.20
LIFT RH							
	6J5843		P-UB-10	2-1/2	5	CTC-7X2675	105.11
LIFT RIPPER							
	3G1762		P-UB-10	2-1/2	5	CTC-7X2658	147.39
	3G5189		P-UB-10	2-1/2	5	CTC-7X2658	147.39
RIPPER							
	5J7686		P-UB-10	2-1/2	6-1/2	CTC-7X2666	143.68
STEERING							
	1U2704		P-UB-10	2	3-1/2	CTC-7X2792	74.25
	4J4115		P-UB-10	1-1/2	4	CTC-7X2738	73.99
	8J5386		P-UB-10	1-1/2	2-3/4	CTC-7X2749	49.96
	9J0541		P-UB-10	1-1/2	2-3/4	CTC-7X2749	49.96
STEERING LH							
	3G7644		P-UB-10	1-1/2	2-3/4	CTC-7X2749	49.96
STEERING RH							
	3G7643		P-UB-10	1-1/2	2-3/4	CTC-7X2749	49.96
WHEEL LEAN							
	3G4751		P-UB-10	1-1/2	3-1/2	CTC-7X2752	80.70
	8J5385		P-UB-10	1-1/2	3-1/2	CTC-7X2752	80.70
	9T3219		P-UB-10	1-1/2	3-1/2	CTC-1327058	87.86
MODEL 14G							
ARTICULATION							
	1U2704		P-UB-10	2	3-1/2	CTC-7X2792	74.25
	6E2446		P-UB-10	2	3-1/2	CTC-7X2783	87.11
	6E4724		P-UB-10	2	3-1/2	CTC-7X2783	87.11
	9T2879		P-UB-10	2	3-1/2	CTC-7X2783	87.11
BACKHOE STICK/BLADE SHIFT							
	8J6359		P-UB-10	2-1/4	3-3/4	CTC-7X2798	64.20
BLADE							
	8J6010		P-UB-10	2-1/4	3-3/4	CTC-7X2798	64.20
BLADE LIFT							
	3G5227		P-UB-10	2-1/4	3-3/4	CTC-7X2798	64.20
BLADE TIP							
	9T3198		P-UB-10	2	4	CTC-1328816	78.46
	9T8944		P-UB-10	2	4	CTC-1328816	78.46

CATERPILLAR®



REPLACEMENT KITS FOR CATERPILLAR® EQUIPMENT

Motor Graders							
APPLICATION	CYL #	Misc-Parts, Instructions, etc.	CODE	ROD	BORE	KIT #	List \$
MODEL 14G							
CENTER SHIFT							
	3G5228		P-UB-10	2-1/4	3-3/4	CTC-7X2798	64.20
CONVEYOR SWING							
	3G5228		P-UB-10	2-1/4	3-3/4	CTC-7X2798	64.20
	8J6250		P-UB-10	2-1/4	3-3/4	CTC-7X2798	64.20
DRAWBAR TIP							
	8J6256		P-UB-10	1-3/4	3	CTC-7X2791	74.94
LIFT RH							
	6J5843		P-UB-10	2-1/2	5	CTC-7X2675	105.11
RIPPER							
	1135264		P-UB-10	2-1/2	5	CTC-1361967	163.90
	3G1762		P-UB-10	2-1/2	5	CTC-1315106	142.87
	3G5189		P-UB-10	2-1/2	5	CTC-7X2658	147.39
SIDESHIFT							
	4T0340		P-UB-10	2-1/2	4	CTC-7X2665	141.19
	9T3206		P-UB-10	2-1/2	4	CTC-1542501	128.09
STEERING LH							
	3G7644		P-UB-10	1-1/2	2-3/4	CTC-7X2749	49.96
	9J0541		P-UB-10	1-1/2	2-3/4	CTC-7X2749	49.96
	9T1721		P-UB-10	1-3/4	2-1/2	CTC-1539054	122.06
STEERING RH							
	3G7643		P-UB-10	1-1/2	2-3/4	CTC-7X2749	49.96
	8J5386		P-UB-10	1-1/2	2-3/4	CTC-7X2749	49.96
	9T1301		P-UB-10	1-3/4	2-1/2	CTC-1539054	122.06
TIP							
	4T0379		P-UB-10	2	4	CTC-1328816	78.46
WHEEL LEAN							
	1219243		P-UB-10	2	3-1/2	CTC-7X2783	87.11
	3G4751		P-UB-10	1-1/2	3-1/2	CTC-7X2752	80.70
	8J5385		P-UB-10	1-1/2	3-1/2	CTC-7X2752	80.70
	9T3219		P-UB-10	1-1/2	3-1/2	CTC-1327058	87.86
MODEL 14H							
ARTICULATION							
	6E2446		P-UB-10	2	3-1/2	CTC-7X2783	87.11
	6E4724		P-UB-10	2	3-1/2	CTC-7X2783	87.11
	9T2879		P-UB-10	2	3-1/2	CTC-7X2783	87.11
BLADE TIP							
	9T3198		P-UB-10	2	4	CTC-1328816	78.46
	9T8944		P-UB-10	2	4	CTC-1328816	78.46
RIPPER							
	1135264		P-UB-10	2-1/2	5	CTC-1361967	163.90
SIDESHIFT							
	9T3206		P-UB-10	2-1/2	4	CTC-1542501	128.09
STEERING LH							
	9T1721		P-UB-10	1-3/4	2-1/2	CTC-1539054	122.06
STEERING RH							
	9T1301		P-UB-10	1-3/4	2-1/2	CTC-1539054	122.06



REPLACEMENT KITS FOR CATERPILLAR® EQUIPMENT

Motor Graders							
APPLICATION	CYL #	Misc-Parts, Instructions, etc.	CODE	ROD	BORE	KIT #	List \$
MODEL 14H							
WHEEL LEAN							
	1219243		P-UB-10	2	3-1/2	CTC-7X2783	87.11
	9T3219		P-UB-10	1-1/2	3-1/2	CTC-1327058	87.86
MODEL 16							
BLADE LH							
	6J5844		P-UB-10	2-1/2	5	CTC-7X2675	105.11
BLADE RH							
	6J5843		P-UB-10	2-1/2	5	CTC-7X2675	105.11
LIFT							
	3G5229		P-UB-10	2-1/2	4-1/4	CTC-7X2663	41.78
STEERING							
	5J1931		P-V-10	2	5	CTC-7X2797	59.98
TIP							
	6J9731		P-UB-10	1-1/2	4	CTC-7X2738	73.99
	6J9732		P-UB-10	1-1/2	4	CTC-7X2738	73.99
MODEL 16G							
ARTICULATION							
	1U1649		P-UB-10	2-1/2	4	CTC-7X2665	141.19
	9T3050		P-UB-10	2-1/2	4	CTC-1542501	128.09
BLADE							
	9T3106		P-UB-10	2-1/2	4	CTC-1542501	128.09
BLADE LIFT							
	3G5229		P-UB-10	2-1/2	4-1/4	CTC-7X2663	41.78
	8J5568		P-UB-10	2-1/2	4-1/4	CTC-7X2663	41.78
BLADE TIP							
	6J9731		P-UB-10	1-1/2	4	CTC-7X2738	73.99
	6J9732		P-UB-10	1-1/2	4	CTC-7X2738	73.99
	9T3198		P-UB-10	2	4	CTC-1328816	78.46
	9T8944		P-UB-10	2	4	CTC-1328816	78.46
CENTER SHIFT							
	3G5230		P-UB-10	2-1/2	4-1/4	CTC-7X2663	41.78
CONVEYOR SWING							
	9T3312		P-UB-10	2-1/2	4	CTC-1542501	128.09
DRAWBAR TIP							
	8J3761		P-UB-10	1-3/4	3	CTC-7X2791	74.94
LIFT							
	8J5827		P-UB-10	2-1/2	4-1/4	CTC-7X2663	41.78
LIFT LH							
	6J5844		P-UB-10	2-1/2	5	CTC-7X2675	105.11
LIFT RH							
	6J5843		P-UB-10	2-1/2	5	CTC-7X2675	105.11
RIPPER							
	1135264		P-UB-10	2-1/2	5	CTC-1361967	163.90
	3G1762		P-UB-10	2-1/2	5	CTC-1315106	142.87
	3G5189		P-UB-10	2-1/2	5	CTC-7X2658	147.39

CATERPILLAR®



REPLACEMENT KITS FOR CATERPILLAR® EQUIPMENT

Motor Graders							
APPLICATION	CYL #	Misc-Parts, Instructions, etc.	CODE	ROD	BORE	KIT #	List \$
MODEL 16G							
SIDESHIFT							
	4T0340		P-UB-10	2-1/2	4	CTC-7X2665	141.19
	9T3206		P-UB-10	2-1/2	4	CTC-1542501	128.09
STEERING							
	1U2704		P-UB-10	2	3-1/2	CTC-7X2792	74.25
STEERING LH							
	3G7599		P-UB-10	1-3/4	3	CTC-7X2791	74.94
	8J3612		P-UB-10	1-3/4	3	CTC-7X2791	74.94
	9T2854		P-UB-10	1-3/4	2-3/4	CTC-1539053	127.54
STEERING RH							
	3G7600		P-UB-10	1-3/4	3	CTC-7X2791	74.94
	8J8411		P-UB-10	1-3/4	3	CTC-7X2791	74.94
	9T2853		P-UB-10	1-3/4	2-3/4	CTC-1539053	127.54
	9T2853		P-UB-10	1-3/4	2-3/4	CTC-7X2820	66.93
TIP							
	4T0379		P-UB-10	2	4	CTC-1328816	78.46
WHEEL LEAN							
	3G4750		P-UB-10	1-3/4	4	CTC-7X2790	78.63
	8J3613		P-UB-10	1-3/4	4	CTC-1316108	91.89
	9T3492		P-UB-10	1-3/4	4	CTC-1316108	91.89
MODEL 16H							
ARTICULATION							
	9T3050		P-UB-10	2-1/2	4	CTC-1542501	128.09
BLADE							
	9T3106		P-UB-10	2-1/2	4	CTC-1542501	128.09
BLADE TIP							
	9T3198		P-UB-10	2	4	CTC-1328816	78.46
	9T8944		P-UB-10	2	4	CTC-1328816	78.46
CONVEYOR SWING							
	9T3312		P-UB-10	2-1/2	4	CTC-1542501	128.09
RIPPER							
	1135264		P-UB-10	2-1/2	5	CTC-1361967	163.90
SIDESHIFT							
	9T3206		P-UB-10	2-1/2	4	CTC-1542501	128.09
STEERING LH							
	9T2854		P-UB-10	1-3/4	2-3/4	CTC-1539053	127.54
STEERING RH							
	9T2853		P-UB-10	1-3/4	2-3/4	CTC-1539053	127.54
WHEEL LEAN							
	9T3492		P-UB-10	1-3/4	4	CTC-1316108	91.89
MODEL 24H							
ARTICULATION							
	1170837		P-UB-10	3	4-3/4	CTC-1570288	145.81
BLADE							
	1170832		P-UB-10	3	5-1/4	CTC-3E3293	150.34
RIPPER							
	1137754		P-UB-10	2	4	CTC-1328816	78.46



REPLACEMENT KITS FOR CATERPILLAR® EQUIPMENT

Motor Graders							
APPLICATION	CYL #	Misc-Parts, Instructions, etc.	CODE	ROD	BORE	KIT #	List \$
MODEL 24H							
STEERING							
	1170833		I-UB-10	2-1/2	3-1/2	CTC-3E3299	113.42
TIP							
	1435988	Rod Bearing width- 0.98"	P-UB-10	2-1/2	4-3/4	CTC-1361131	121.12
WHEEL LEAN							
	1170836	Rod Bearing width- 0.98"	P-UB-10	2-1/2	4-3/4	CTC-1361131	121.12
MODEL 112							
STEERING							
	4J4115		P-UB-10	1-1/2	4	CTC-7X2738	73.99
MODEL 112E							
STEERING							
	4J4115		P-UB-10	1-1/2	4	CTC-7X2738	73.99
MODEL 112F							
STEERING							
	4J4115		P-UB-10	1-1/2	4	CTC-7X2738	73.99
MODEL 120							
STEERING							
	4J4115		P-UB-10	1-1/2	4	CTC-7X2738	73.99
MODEL 120B							
STEERING							
	4J4115		P-UB-10	1-1/2	4	CTC-7X2738	73.99
MODEL 120G							
ARTICULATION							
	8J8590		P-UB-10	1-3/4	3	CTC-7X2791	74.94
	9T2447		P-UB-10	1-3/4	3	CTC-7X2825	42.17
	9T8785		P-UB-10	1-3/4	3	CTC-7X2825	42.17
BACKHOE STICK/BLADE SHIFT							
	8J0028		P-UB-10	1-3/4	3	CTC-7X2791	74.94
	9T2483		P-UB-10	1-3/4	3	CTC-7X2825	42.17
BLADE							
	3G5225		P-UB-10	1-3/4	3	CTC-7X2791	74.94
	8J8589		P-UB-10	1-3/4	3	CTC-7X2791	74.94
	9T2471		P-UB-10	1-3/4	3	CTC-7X2825	42.17
BLADE LIFT							
	3G5225		P-UB-10	1-3/4	3	CTC-7X2791	74.94
BLADE RH							
	6J5843		P-UB-10	2-1/2	5	CTC-7X2675	105.11
BLADE TIP							
	6E1549		P-UB-10	1-1/2	2-3/4	CTC-1361599	90.09
	8J0024		P-UB-10	1-1/2	2-3/4	CTC-7X2749	49.96
	9J3466		P-UB-10	1-1/2	2-3/4	CTC-7X2749	49.96
	9T2461		P-UB-10	1-1/2	2-3/4	CTC-1361599	90.09
CENTER SHIFT							
	3G5226		P-UB-10	1-3/4	3	CTC-7X2791	74.94
	8J6367		P-UB-10	2	3-1/4	CTC-7X2767	54.31
	9T2374		P-UB-10	1-3/4	3	CTC-7X2825	42.17

CATERPILLAR®



REPLACEMENT KITS FOR CATERPILLAR® EQUIPMENT

Motor Graders							
APPLICATION	CYL #	Misc-Parts, Instructions, etc.	CODE	ROD	BORE	KIT #	List \$
MODEL 120G							
CONVEYOR SWING							
	3G5226		P-UB-10	1-3/4	3	CTC-7X2791	74.94
	8J8777		P-UB-10	1-3/4	3	CTC-7X2791	74.94
	9T2374		P-UB-10	1-3/4	3	CTC-7X2825	42.17
SCARIFIER							
	3G1853		P-UB-10	1-3/4	3	CTC-7X2791	74.94
	8J7321		P-UB-10	1-1/2	3	CTC-7X2751	54.17
	9T2554		P-UB-10	1-3/4	3	CTC-7X2825	42.17
	9T6951		P-UB-10	1-3/4	3	CTC-7X2825	42.17
SIDESHIFT							
	1052094		P-UB-10	1-3/4	3	CTC-7X2825	42.17
	8J0028		P-UB-10	1-3/4	3	CTC-7X2791	74.94
	9T2483		P-UB-10	1-3/4	3	CTC-7X2825	42.17
STEERING LH							
	3G8070		P-UB-10	1-1/2	2-1/2	CTC-7X2739	47.83
	8J8820		P-UB-10	1-1/2	2-1/2	CTC-7X2739	47.83
	9T2395		P-UB-10	1-1/2	2-1/4	CTC-7X2826	34.46
STEERING RH							
	3G8069		P-UB-10	1-1/2	2-1/2	CTC-7X2739	47.83
	8J5538		P-UB-10	1-1/2	2-1/2	CTC-7X2739	47.83
	9T2393		P-UB-10	1-1/2	2-1/4	CTC-7X2826	34.46
WHEEL LEAN							
	1219242		P-UB-10	2	3-1/2	CTC-7X2783	87.11
	3G4752		P-UB-10	1-1/2	3-1/2	CTC-7X2752	80.70
	8J5539		P-UB-10	1-1/2	3-1/2	CTC-7X2752	80.70
	9T2520		P-UB-10	1-1/2	3-1/2	CTC-1327058	87.86
MODEL 120H							
ARTICULATION							
	6E1554		P-UB-10	1-3/4	3	CTC-7X2825	42.17
	6E4724		P-UB-10	2	3-1/2	CTC-7X2783	87.11
	9T8785		P-UB-10	1-3/4	3	CTC-7X2825	42.17
BLADE							
	1125575		P-UB-10	1-3/4	3	CTC-7X2825	42.17
	1198664		P-UB-10	2	3	CTC-7X2760	54.39
	1324926		P-UB-10	2	3	CTC-7X2760	54.39
BLADE TIP							
	6E1549		P-UB-10	1-1/2	2-3/4	CTC-1361599	90.09
CONVEYOR SWING							
	6E1754		P-UB-10	2	3	CTC-7X2760	54.39
SCARIFIER							
	9T2554		P-UB-10	1-3/4	3	CTC-7X2825	42.17
	9T6951		P-UB-10	1-3/4	3	CTC-7X2825	42.17
STEERING LH							
	9T2395		P-UB-10	1-1/2	2-1/4	CTC-7X2826	34.46
STEERING RH							
	9T2393		P-UB-10	1-1/2	2-1/4	CTC-7X2826	34.46



REPLACEMENT KITS FOR CATERPILLAR® EQUIPMENT

Motor Graders							
APPLICATION	CYL #	Misc-Parts, Instructions, etc.	CODE	ROD	BORE	KIT #	List \$
MODEL 120H							
WHEEL LEAN							
	1219242		P-UB-10	2	3-1/2	CTC-7X2783	87.11
	9T2520		P-UB-10	1-1/2	3-1/2	CTC-1327058	87.86
MODEL 130G							
ARTICULATION							
	8J0546		P-UB-10	1-3/4	3	CTC-7X2791	74.94
	9T2453		P-UB-10	1-3/4	3	CTC-7X2825	42.17
	9T8784		P-UB-10	1-3/4	3	CTC-7X2825	42.17
BACKHOE STICK/BLADE SHIFT							
	8J0028		P-UB-10	1-3/4	3	CTC-7X2791	74.94
	9T2483		P-UB-10	1-3/4	3	CTC-7X2825	42.17
BLADE							
	3G5223		P-UB-10	2	3-1/4	CTC-7X2767	54.31
	8J6380		P-UB-10	2	3-1/4	CTC-7X2767	54.31
	9T2472		P-UB-10	2	3	CTC-7X2760	54.39
BLADE LIFT							
	3G5223		P-UB-10	2	3-1/4	CTC-7X2767	54.31
	9T2471		P-UB-10	1-3/4	3	CTC-7X2825	42.17
	9T2472		P-UB-10	2	3	CTC-7X2753	50.05
BLADE TIP							
	6E1549		P-UB-10	1-1/2	2-3/4	CTC-1361599	90.09
	8J0024		P-UB-10	1-1/2	2-3/4	CTC-7X2749	49.96
	9J3466		P-UB-10	1-1/2	2-3/4	CTC-7X2749	49.96
	9T2461		P-UB-10	1-1/2	2-3/4	CTC-1361599	90.09
CENTER SHIFT							
	3G5224		P-UB-10	2	3-1/4	CTC-7X2767	54.31
	8J6367		P-UB-10	2	3-1/4	CTC-7X2767	54.31
	9T2549		P-UB-10	2	3	CTC-7X2760	54.39
CONVEYOR SWING							
	3G5224		P-UB-10	2	3-1/4	CTC-7X2767	54.31
	8J6367		P-UB-10	2	3-1/4	CTC-7X2767	54.31
	9T2549		P-UB-10	2	3	CTC-7X2760	54.39
LIFT							
	9T2471		P-UB-10	1-3/4	3	CTC-7X2825	42.17
RIPPER							
	1137754		P-UB-10	2	4	CTC-1328816	78.46
	8J1658		P-UB-10	2	4	CTC-1328816	78.46
SCARIFIER							
	3G1853		P-UB-10	1-3/4	3	CTC-7X2791	74.94
	8J7321		P-UB-10	1-1/2	3	CTC-7X2751	54.17
	9T2554		P-UB-10	1-3/4	3	CTC-7X2825	42.17
	9T6951		P-UB-10	1-3/4	3	CTC-7X2825	42.17
SIDESHIFT							
	1052094		P-UB-10	1-3/4	3	CTC-7X2825	42.17
	8J0028		P-UB-10	1-3/4	3	CTC-7X2791	74.94
	9T2483		P-UB-10	1-3/4	3	CTC-7X2825	42.17

CATERPILLAR®



REPLACEMENT KITS FOR CATERPILLAR® EQUIPMENT

Motor Graders							
APPLICATION	CYL #	Misc-Parts, Instructions, etc.	CODE	ROD	BORE	KIT #	List \$
MODEL 130G							
STEERING LH							
	3G8070		P-UB-10	1-1/2	2-1/2	CTC-7X2739	47.83
	8J8820		P-UB-10	1-1/2	2-1/2	CTC-7X2739	47.83
	9T2395		P-UB-10	1-1/2	2-1/4	CTC-7X2826	34.46
STEERING RH							
	3G8069		P-UB-10	1-1/2	2-1/2	CTC-7X2739	47.83
	8J5538		P-UB-10	1-1/2	2-1/2	CTC-7X2739	47.83
	9T2393		P-UB-10	1-1/2	2-1/4	CTC-7X2826	34.46
WHEEL LEAN							
	1219242		P-UB-10	2	3-1/2	CTC-7X2783	87.11
	3G4752		P-UB-10	1-1/2	3-1/2	CTC-7X2752	80.70
	8J5539		P-UB-10	1-1/2	3-1/2	CTC-7X2752	80.70
	9T2520		P-UB-10	1-1/2	3-1/2	CTC-1327058	87.86
MODEL 135H							
ARTICULATION							
	6E1554		P-UB-10	1-3/4	3	CTC-7X2825	42.17
	6E4724		P-UB-10	2	3-1/2	CTC-7X2783	87.11
	9T8785		P-UB-10	1-3/4	3	CTC-7X2825	42.17
BLADE							
	1324926		P-UB-10	2	3	CTC-7X2760	54.39
BLADE TIP							
	6E1549		P-UB-10	1-1/2	2-3/4	CTC-1361599	90.09
CONVEYOR SWING							
	6E1754		P-UB-10	2	3	CTC-7X2760	54.39
SCARIFIER							
	9T2554		P-UB-10	1-3/4	3	CTC-7X2825	42.17
	9T6951		P-UB-10	1-3/4	3	CTC-7X2825	42.17
SIDESHIFT							
	1125575		P-UB-10	1-3/4	3	CTC-7X2825	42.17
STEERING LH							
	9T2395		P-UB-10	1-1/2	2-1/4	CTC-7X2826	34.46
STEERING RH							
	9T2393		P-UB-10	1-1/2	2-1/4	CTC-7X2826	34.46
WHEEL LEAN							
	1219242		P-UB-10	2	3-1/2	CTC-7X2783	87.11
	9T2520		P-UB-10	1-1/2	3-1/2	CTC-1327058	87.86
MODEL 140B							
RIPPER							
	3G5189		P-UB-10	2-1/2	5	CTC-7X2658	147.39
STEERING							
	4J4115		P-UB-10	1-1/2	4	CTC-7X2738	73.99
MODEL 140G							
ARTICULATION							
	8J0546		P-UB-10	1-3/4	3	CTC-7X2791	74.94
	9T2453		P-UB-10	1-3/4	3	CTC-7X2825	42.17
	9T8784		P-UB-10	1-3/4	3	CTC-7X2825	42.17



REPLACEMENT KITS FOR CATERPILLAR® EQUIPMENT

Motor Graders							
APPLICATION	CYL #	Misc-Parts, Instructions, etc.	CODE	ROD	BORE	KIT #	List \$
MODEL 140G							
BACKHOE STICK/BLADE SHIFT							
	8J0028		P-UB-10	1-3/4	3	CTC-7X2791	74.94
BLADE							
	3G5223		P-UB-10	2	3-1/4	CTC-7X2767	54.31
	8J6380		P-UB-10	2	3-1/4	CTC-7X2767	54.31
	9T2472		P-UB-10	2	3	CTC-7X2760	54.39
BLADE LIFT							
	9T2472		P-UB-10	2	3	CTC-7X2753	50.05
BLADE TIP							
	6E1549		P-UB-10	1-1/2	2-3/4	CTC-1361599	90.09
	8J0024		P-UB-10	1-1/2	2-3/4	CTC-7X2749	49.96
	9J3466		P-UB-10	1-1/2	2-3/4	CTC-7X2749	49.96
	9T2461		P-UB-10	1-1/2	2-3/4	CTC-1361599	90.09
CENTER SHIFT							
	3G5224		P-UB-10	2	3-1/4	CTC-7X2767	54.31
	8J6367		P-UB-10	2	3-1/4	CTC-7X2767	54.31
	9T2549		P-UB-10	2	3	CTC-7X2760	54.39
CONVEYOR SWING							
	3G5224		P-UB-10	2	3-1/4	CTC-7X2767	54.31
	8J6367		P-UB-10	2	3-1/4	CTC-7X2767	54.31
	9T2549		P-UB-10	2	3	CTC-7X2760	54.39
RIPPER							
	1137754		P-UB-10	2	4	CTC-1328816	78.46
	8J1658		P-UB-10	2	4	CTC-1328816	78.46
RIPPER LIFT							
	3G5189		P-UB-10	2-1/2	5	CTC-7X2658	147.39
SCARIFIER							
	3G1853		P-UB-10	1-3/4	3	CTC-7X2791	74.94
	8J7321		P-UB-10	1-1/2	3	CTC-7X2751	54.17
	9T2554		P-UB-10	1-3/4	3	CTC-7X2825	42.17
	9T6951		P-UB-10	1-3/4	3	CTC-7X2825	42.17
SIDESHIFT							
	1052094		P-UB-10	1-3/4	3	CTC-7X2825	42.17
	8J0028		P-UB-10	1-3/4	3	CTC-7X2791	74.94
	9T2483		P-UB-10	1-3/4	3	CTC-7X2825	42.17
STEERING LH							
	3G8070		P-UB-10	1-1/2	2-1/2	CTC-7X2739	47.83
	8J8820		P-UB-10	1-1/2	2-1/2	CTC-7X2739	47.83
	9T2395		P-UB-10	1-1/2	2-1/4	CTC-7X2826	34.46
STEERING RH							
	3G8069		P-UB-10	1-1/2	2-1/2	CTC-7X2739	47.83
	8J5538		P-UB-10	1-1/2	2-1/2	CTC-7X2739	47.83
	9T2393		P-UB-10	1-1/2	2-1/4	CTC-7X2826	34.46

CATERPILLAR®



REPLACEMENT KITS FOR CATERPILLAR® EQUIPMENT

Motor Graders							
APPLICATION	CYL #	Misc-Parts, Instructions, etc.	CODE	ROD	BORE	KIT #	List \$
MODEL 140G							
WHEEL LEAN							
	1219242		P-UB-10	2	3-1/2	CTC-7X2783	87.11
	3G4752		P-UB-10	1-1/2	3-1/2	CTC-7X2752	80.70
	4J4115		P-UB-10	1-1/2	4	CTC-7X2738	73.99
	8J5539		P-UB-10	1-1/2	3-1/2	CTC-7X2752	80.70
	9T2520		P-UB-10	1-1/2	3-1/2	CTC-1327058	87.86
MODEL 140H, 143H							
ARTICULATION							
	1376790		P-UB-10	1-7/8	3-1/4	CTC-3E3297	83.37
	1376792		P-UB-10	1-7/8	3-1/4	CTC-3E3297	83.37
	6E1560		P-UB-10	1-3/4	3	CTC-7X2825	42.17
	9T8784		P-UB-10	1-3/4	3	CTC-7X2825	42.17
BLADE							
	1324929		P-UB-10	2	3	CTC-7X2760	54.39
BLADE TIP							
	6E1549		P-UB-10	1-1/2	2-3/4	CTC-1361599	90.09
CONVEYOR SWING							
	6E1343		P-UB-10	2	3	CTC-7X2760	54.39
RIPPER							
	1137754		P-UB-10	2	4	CTC-1328816	78.46
SCARIFIER							
	9T2554		P-UB-10	1-3/4	3	CTC-7X2825	42.17
	9T6951		P-UB-10	1-3/4	3	CTC-7X2825	42.17
SIDESHIFT							
	1125575		P-UB-10	1-3/4	3	CTC-7X2825	42.17
STEERING LH							
	9T2395		P-UB-10	1-1/2	2-1/4	CTC-7X2826	34.46
STEERING RH							
	9T2393		P-UB-10	1-1/2	2-1/4	CTC-7X2826	34.46
WHEEL LEAN							
	1219242		P-UB-10	2	3-1/2	CTC-7X2783	87.11
	9T2520		P-UB-10	1-1/2	3-1/2	CTC-1327058	87.86
MODEL 160G							
ARTICULATION							
	8J0546		P-UB-10	1-3/4	3	CTC-7X2791	74.94
	9T2453		P-UB-10	1-3/4	3	CTC-7X2825	42.17
	9T8784		P-UB-10	1-3/4	3	CTC-7X2825	42.17
BACKHOE STICK/BLADE SHIFT							
	8J0028		P-UB-10	1-3/4	3	CTC-7X2791	74.94
BLADE							
	3G5223		P-UB-10	2	3-1/4	CTC-7X2767	54.31
	8J6380		P-UB-10	2	3-1/4	CTC-7X2767	54.31
	9T2472		P-UB-10	2	3	CTC-7X2753	50.05
	9T2472		P-UB-10	2	3	CTC-7X2760	54.39
BLADE LIFT							
	3G5223		P-UB-10	2	3-1/4	CTC-7X2767	54.31
	9T2472		P-UB-10	2	3	CTC-7X2753	50.05



REPLACEMENT KITS FOR CATERPILLAR® EQUIPMENT

Motor Graders							
APPLICATION	CYL #	Misc-Parts, Instructions, etc.	CODE	ROD	BORE	KIT #	List \$
MODEL 160G							
BLADE TIP							
	6E1549		P-UB-10	1-1/2	2-3/4	CTC-1361599	90.09
	8J0024		P-UB-10	1-1/2	2-3/4	CTC-7X2749	49.96
	9J3466		P-UB-10	1-1/2	2-3/4	CTC-7X2749	49.96
	9T2461		P-UB-10	1-1/2	2-3/4	CTC-1361599	90.09
CENTER SHIFT							
	3G5224		P-UB-10	2	3-1/4	CTC-7X2767	54.31
	9T2549		P-UB-10	2	3	CTC-7X2760	54.39
CONVEYOR SWING							
	3G5224		P-UB-10	2	3-1/4	CTC-7X2767	54.31
	8J6367		P-UB-10	2	3-1/4	CTC-7X2767	54.31
	9T2549		P-UB-10	2	3	CTC-7X2760	54.39
SCARIFIER							
	3G1853		P-UB-10	1-3/4	3	CTC-7X2791	74.94
	9T2554		P-UB-10	1-3/4	3	CTC-7X2825	42.17
	9T6951		P-UB-10	1-3/4	3	CTC-7X2825	42.17
SIDESHIFT							
	1052094		P-UB-10	1-3/4	3	CTC-7X2825	42.17
	8J0028		P-UB-10	1-3/4	3	CTC-7X2791	74.94
	9T2483		P-UB-10	1-3/4	3	CTC-7X2825	42.17
STEERING LH							
	3G8070		P-UB-10	1-1/2	2-1/2	CTC-7X2739	47.83
	8J8820		P-UB-10	1-1/2	2-1/2	CTC-7X2739	47.83
	9T2395		P-UB-10	1-1/2	2-1/4	CTC-7X2826	34.46
STEERING RH							
	3G8069		P-UB-10	1-1/2	2-1/2	CTC-7X2739	47.83
	8J5538		P-UB-10	1-1/2	2-1/2	CTC-7X2739	47.83
	9T2393		P-UB-10	1-1/2	2-1/4	CTC-7X2826	34.46
WHEEL LEAN							
	1219242		P-UB-10	2	3-1/2	CTC-7X2783	87.11
	3G4752		P-UB-10	1-1/2	3-1/2	CTC-7X2752	80.70
	9T2520		P-UB-10	1-1/2	3-1/2	CTC-1327058	87.86
MODEL 160H, 163H							
ARTICULATION							
	1376790		P-UB-10	1-7/8	3-1/4	CTC-3E3297	83.37
	1376792		P-UB-10	1-7/8	3-1/4	CTC-3E3297	83.37
	6E1560		P-UB-10	1-3/4	3	CTC-7X2825	42.17
	9T8784		P-UB-10	1-3/4	3	CTC-7X2825	42.17
BLADE							
	1324929		P-UB-10	2	3	CTC-7X2760	54.39
BLADE TIP							
	6E1549		P-UB-10	1-1/2	2-3/4	CTC-1361599	90.09
CONVEYOR SWING							
	6E1343		P-UB-10	2	3	CTC-7X2760	54.39
RIPPER							
	1137754		P-UB-10	2	4	CTC-1328816	78.46

CATERPILLAR®



REPLACEMENT KITS FOR CATERPILLAR® EQUIPMENT

Motor Graders							
APPLICATION	CYL #	Misc-Parts, Instructions, etc.	CODE	ROD	BORE	KIT #	List \$
MODEL 160H, 163H							
SCARIFIER							
	9T2554		P-UB-10	1-3/4	3	CTC-7X2825	42.17
	9T6951		P-UB-10	1-3/4	3	CTC-7X2825	42.17
SIDESHIFT							
	1125575		P-UB-10	1-3/4	3	CTC-7X2825	42.17
STEERING LH							
	9T2395		P-UB-10	1-1/2	2-1/4	CTC-7X2826	34.46
STEERING RH							
	9T2393		P-UB-10	1-1/2	2-1/4	CTC-7X2826	34.46
WHEEL LEAN							
	1219242		P-UB-10	2	3-1/2	CTC-7X2783	87.11
	9T2520		P-UB-10	1-1/2	3-1/2	CTC-1327058	87.86
Off-Highway Trucks							
APPLICATION	CYL #	Misc-Parts, Instructions, etc.	CODE	ROD	BORE	KIT #	List \$
MODEL 768							
HOIST							
	4T4168		I-SP-10	4,6-1/2	5-3/4	CTC-8T4772	266.06
STEERING							
	9J1287		P-UB-10	2-3/8	3-3/4	CTC-7X2808	68.21
SUSPENSION REAR							
	5J6572		I-SP-1	7	8-1/2	CTC-5J6572K	178.67
MODEL 768B							
STEERING							
	7J7528		P-UB-10	2-3/8	3-3/4	CTC-7X2808	68.21
	9J1287		P-UB-10	2-3/8	3-3/4	CTC-7X2808	68.21
SUSPENSION FRONT							
	79S1; 02X1-						
			P-UB-3	7	8	CTC-1137475	386.82
SUSPENSION REAR							
			P-U-3	7	8-1/2	CTC-2959886	232.53
	5J6572		I-SP-1	7	8-1/2	CTC-5J6572K	178.67
MODEL 768C							
HOIST							
	9J4149		I-SP-10	4,6-1/2	5-3/4	CTC-8T4772	266.06
STEERING							
			P-UB-10	2-3/8	3-3/4	CTC-2578422	44.74
			P-UB-10	2	3	CTC-2937596	33.87
SUSPENSION FRONT							
	79S1; 02X1-						
			P-UB-3	7	8	CTC-1137475	386.82
SUSPENSION REAR							
			P-U-3	7	8-1/2	CTC-2959886	232.53
	5J6572		I-SP-1	7	8-1/2	CTC-5J6572K	178.67
MODEL 769, 769B							
STEERING							
			P-UB-10	2-3/8	3-3/4	CTC-2578422	44.74
	4J4627	Field Replacement Kit	P-UB-10	1-1/2	3-1/2	CTC-7X2812	88.00



REPLACEMENT KITS FOR CATERPILLAR® EQUIPMENT

Off-Highway Trucks							
APPLICATION	CYL #	Misc-Parts, Instructions, etc.	CODE	ROD	BORE	KIT #	List \$
MODEL 769, 769B							
STEERING							
99F1031-99F1198							
6J1203			I-UB-10	2-3/8	3-3/4	CTC-6J1203K	99.45
99F1199-99F4068							
7J7528			P-UB-10	2-3/8	3-3/4	CTC-7X2808	68.21
99F1-99F1030							
4J4627			I,P-V-10	1-1/2	3-1/2	CTC-4J4627K	70.75
99F4069-							
9J1287			P-UB-10	2-3/8	3-3/4	CTC-7X2808	68.21
SUSPENSION							
7J8286			P-UB-3	7	8	CTC-1137475	386.82
SUSPENSION REAR							
99F1031-; 35W							
5J6572			I-SP-1	7	8-1/2	CTC-5J6572K	178.67
99F1-99F1030							
4J8770			I-SP-1	7	8-1/2	CTC-4J8770K	181.80
MODEL 769C							
HOIST							
4T4168			I-SP-10	4,6-1/2	5-3/4	CTC-8T4772	266.06
9J4149			I-SP-10	4,6-1/2	5-3/4	CTC-8T4772	266.06
STEERING							
			P-UB-10	2-3/8	3-3/4	CTC-2578422	44.74
			P-UB-10	2	3	CTC-2937596	33.87
SUSPENSION FRONT							
			P-UB-3	7	8	CTC-2950148	554.50
01X2920-; 3BJ1-; 5TR; 6JR; 5SS; 6YS; 9XS; BCA; BBB							
			P-UB-3	7	8	CTC-1137475	386.82
SUSPENSION REAR							
			P-U-3	7	8-1/2	CTC-2959886	232.53
5J6572			I-SP-1	7	8-1/2	CTC-5J6572K	178.67
1X1-1X3271							
3G0688			I-SP-1	7	8-1/2	CTC-5J6572K	178.67
1X3272-							
3G0688			I-SP-1	7	8-1/2	CTC-3G0688K	178.67
MODEL 769D							
HOIST							
4T4168			I-SP-10	4,6-1/2	5-3/4	CTC-8T4772	266.06
9J4149			I-SP-10	4,6-1/2	5-3/4	CTC-8T4772	266.06
STEERING							
			P-UB-10	2	3	CTC-2937596	33.87
1100532			P-UB-10	2	3	CTC-7X2760	54.39
9J1287			P-UB-10	2-3/8	3-3/4	CTC-7X2808	68.21
SUSPENSION FRONT							
01X2920-; 3BJ1-; 5TR; 6JR; 5SS; 6YS; 9XS; BCA; BBB							
			P-UB-3	7	8	CTC-1137475	386.82
SUSPENSION REAR							
			P-U-3	7	8-1/2	CTC-2959886	232.53

CATERPILLAR®



REPLACEMENT KITS FOR CATERPILLAR® EQUIPMENT

Off-Highway Trucks							
APPLICATION	CYL #	Misc-Parts, Instructions, etc.	CODE	ROD	BORE	KIT #	List \$
MODEL 769D							
UNSPECIFIED APPLICATION							
	1303921		P-UB-3	7	8	CTC-1137475	386.82
MODEL 770							
STEERING							
			P-UB-10	2	3	CTC-2937596	33.87
MODEL 771C							
HOIST							
	4T4168		I-SP-10	4,6-1/2	5-3/4	CTC-8T4772	266.06
	9J4149		I-SP-10	4,6-1/2	5-3/4	CTC-8T4772	266.06
STEERING							
			P-UB-10	2	3	CTC-2937596	33.87
	9J1287		P-UB-10	2-3/8	3-3/4	CTC-7X2808	68.21
SUSPENSION FRONT							
			P-UB-3	7	8	CTC-2950148	554.50
	01X2920-; 3BJ1-; 5TR; 6JR; 5SS; 6YS; 9XS; BCA; BBB						
			P-UB-3	7	8	CTC-1137475	386.82
SUSPENSION REAR							
			P-U-3	7	8-1/2	CTC-2959886	232.53
UNSPECIFIED APPLICATION							
	9J5476		P-UB-3	7	8	CTC-1137475	386.82
MODEL 771D							
HOIST							
	4T4168		I-SP-10	4,6-1/2	5-3/4	CTC-8T4772	266.06
	9J4149		I-SP-10	4,6-1/2	5-3/4	CTC-8T4772	266.06
STEERING							
			P-UB-10	2	3	CTC-2937596	33.87
	1100532		P-UB-10	2	3	CTC-7X2760	54.39
	9J1287		P-UB-10	2-3/8	3-3/4	CTC-7X2808	68.21
SUSPENSION FRONT							
	01X2920-; 3BJ1-; 5TR; 6JR; 5SS; 6YS; 9XS; BCA; BBB						
			P-UB-3	7	8	CTC-1137475	386.82
SUSPENSION REAR							
			P-U-3	7	8-1/2	CTC-2959886	232.53
MODEL 772							
SUSPENSION FRONT							
	64W168-						
			P-UB-3	7	8	CTC-1137478	554.50
MODEL 772B							
SUSPENSION FRONT							
			P-UB-3	7	8	CTC-2950148	554.50
	64W168-						
			P-UB-3	7	8	CTC-1137478	554.50
SUSPENSION REAR							
			P-U-3	7	8-1/2	CTC-2959886	232.53
MODEL 772E							
SUSPENSION REAR							
			P-U-3	7	8-1/2	CTC-2959886	232.53



REPLACEMENT KITS FOR CATERPILLAR® EQUIPMENT

Off-Highway Trucks							
APPLICATION	CYL #	Misc-Parts, Instructions, etc.	CODE	ROD	BORE	KIT #	List \$
MODEL 773							
STEERING							
			P-UB-10	2-3/8	4	CTC-2418925	47.77
63G1-; 63W1-							
	7J7686		P-UB-10	2-3/8	4	CTC-8T1389	40.27
SUSPENSION FRONT							
63G-63G670							
	7J3480		P-UB-3	7	8	CTC-1137475	386.82
63G671-							
	8J2322		P-UB-3	7	8	CTC-1137475	386.82
63W1271-; 7XJ1-; 6KR; 7ER; 7CS; 8AS							
			P-UB-3	7	8	CTC-1137478	554.50
SUSPENSION REAR							
63G; 63W1-63W1724							
	8J9332		I-SP-1	7	8-1/2	CTC-5J6572K	178.67
63W1725-							
	8J9332		I-SP-1	7	8-1/2	CTC-3G0688K	178.67
MODEL 773B							
DOOR							
	3G4640		P-UB-10	2-1/2	6	CTC-7X2669	197.74
HOIST							
			I-SP-10	5,7-1/2	6-1/2,8-1/4	CTC-3126388	406.30
	9J2017		I-SP-10	5,7-1/2	8-1/4	CTC-8T9042	385.00
	9T3122		I-SP-10	5,7-1/2	8-1/4	CTC-8T9042	385.00
STEERING RH							
63G1-; 63W1-							
	7J7686		P-UB-10	2-3/8	4	CTC-8T1389	40.27
SUSPENSION FRONT							
			P-UB-3	7	8	CTC-2950148	554.50
63W1271-; 7XJ1-; 6KR; 7ER; 7CS; 8AS							
			P-UB-3	7	8	CTC-1137478	554.50
SUSPENSION REAR							
63G; 63W1-63W1724							
	8J9332		I-SP-1	7	8-1/2	CTC-5J6572K	178.67
63W1725-							
	8J9332		I-SP-1	7	8-1/2	CTC-3G0688K	178.67
UNSPECIFIED APPLICATION							
	1163092		P-UB-3	7	8	CTC-1137478	554.50
MODEL 773D							
HOIST							
			I-SP-10	5,7-1/2	6-1/2,8-1/4	CTC-3126388	406.30
	1455155		I-SP-10	5,7-1/2	8-1/4	CTC-8T9042	385.00
	9J2017		I-SP-10	5,7-1/2	8-1/4	CTC-8T9042	385.00
STEERING RH							
	7J7686		P-UB-10	2-3/8	4	CTC-8T1389	40.27
SUSPENSION FRONT							
			P-UB-3	7	8	CTC-2950148	554.50
	1163092		P-UB-3	7	8	CTC-1137478	554.50
	1U4777		P-UB-3	7	8	CTC-1137478	554.50

CATERPILLAR®



REPLACEMENT KITS FOR CATERPILLAR® EQUIPMENT

Off-Highway Trucks							
APPLICATION	CYL #	Misc-Parts, Instructions, etc.	CODE	ROD	BORE	KIT #	List \$
MODEL 773D							
SUSPENSION FRONT							
		63W1271-; 7XJ1-; 6KR; 7ER; 7CS; 8AS					
			P-UB-3	7	8	CTC-1137478	554.50
MODEL 773E							
HOIST							
			I-SP-10	5,7-1/2	6-1/2,8-1/4	CTC-3126388	406.30
STEERING							
			P-UB-10	2-1/2	3-1/2	CTC-2949583	59.35
SUSPENSION FRONT							
			P-UB-3	7	8	CTC-2950148	554.50
SUSPENSION REAR							
			P-U-3	7	8-1/2	CTC-2976848	240.78
MODEL 773F							
SUSPENSION REAR							
			P-U-3	7	8-1/2	CTC-2976848	240.78
MODEL 775							
HOIST							
	9J2017		I-SP-10	5,7-1/2	8-1/4	CTC-8T9042	385.00
	9T3122		I-SP-10	5,7-1/2	8-1/4	CTC-8T9042	385.00
STEERING RH							
	7J7686		P-UB-10	2-3/8	4	CTC-8T1389	40.27
UNSPECIFIED APPLICATION							
	1163092		P-UB-3	7	8	CTC-1137478	554.50
	1U4777		P-UB-3	7	8	CTC-1137478	554.50
MODEL 775B							
HOIST							
			I-SP-10	5,7-1/2	6-1/2,8-1/4	CTC-3126388	406.30
SUSPENSION							
	1U4777		P-UB-3	7	8	CTC-1137478	554.50
SUSPENSION FRONT							
			P-UB-3	7	8	CTC-2950148	554.50
		63W1271-; 7XJ1-; 6KR; 7ER; 7CS; 8AS					
			P-UB-3	7	8	CTC-1137478	554.50
SUSPENSION REAR							
			P-U-3	7	8-1/2	CTC-2959886	232.53
MODEL 775D							
HOIST							
			I-SP-10	5,7-1/2	6-1/2,8-1/4	CTC-3126388	406.30
	1455155		I-SP-10	5,7-1/2	8-1/4	CTC-8T9042	385.00
	9J2017		I-SP-10	5,7-1/2	8-1/4	CTC-8T9042	385.00
	9T3122		I-SP-10	5,7-1/2	8-1/4	CTC-8T9042	385.00
STEERING RH							
	7J7686		P-UB-10	2-3/8	4	CTC-8T1389	40.27
SUSPENSION FRONT							
			P-UB-3	7	8	CTC-2950148	554.50
		63W1271-; 7XJ1-; 6KR; 7ER; 7CS; 8AS					
			P-UB-3	7	8	CTC-1137478	554.50

CATERPILLAR®



REPLACEMENT KITS FOR CATERPILLAR® EQUIPMENT

Off-Highway Trucks							
APPLICATION	CYL #	Misc-Parts, Instructions, etc.	CODE	ROD	BORE	KIT #	List \$
MODEL 775D							
SUSPENSION REAR							
			P-U-3	7	8-1/2	CTC-2959886	232.53
UNSPECIFIED APPLICATION							
	1163092		P-UB-3	7	8	CTC-1137478	554.50
	1U4777		P-UB-3	7	8	CTC-1137478	554.50
MODEL 776C							
SUSPENSION REAR							
			P-UB-1	9	10-1/2	CTC-2959885	223.16
MODEL 776D							
SUSPENSION REAR							
			P-UB-1	9	10-1/2	CTC-2959885	223.16
MODEL 777							
DOOR							
	3G4640		P-UB-10	2-1/2	6	CTC-7X2669	197.74
HOIST							
	8J8924		I-UB-10	5-1/2	9-1/2	CTC-8T1543	368.12
STEERING							
			P-UB-10	2-3/8	4	CTC-2418925	47.77
	84A1-; 4YC1-						
	8J9912		P-UB-10	2-3/8	4	CTC-8T1389	40.27
SUSPENSION FRONT							
	4T4756		I, P-U-3	9	10-3/4	CTC-1137463	1593.80
SUSPENSION REAR							
	8J8865		I, P-U-13	9	10-1/2	CTC-1137482	302.00
	84A1284-; 4YC1-						
	8J8865		I-SP-1	9	10-1/2	CTC-9T3972K	403.71
	84A1-84A1283						
	8J8865		I-SP-1	9	10-1/2	CTC-8J8902K	403.71
MODEL 777B							
HOIST							
	8J8924		I-UB-10	5-1/2	9-1/2	CTC-8T1543	368.12
STEERING							
	8J9912		P-UB-10	2-3/8	4	CTC-8T1389	40.27
SUSPENSION FRONT							
	4T4756		I, P-U-3	9	10-3/4	CTC-1137463	1593.80
SUSPENSION REAR							
	8J8865		I, P-U-13	9	10-1/2	CTC-1137482	302.00
	84A1284-; 4YC1-						
	8J8865		I-SP-1	9	10-1/2	CTC-9T3972K	403.71
	84A1-84A1283						
	8J8865		I-SP-1	9	10-1/2	CTC-8J8902K	403.71
MODEL 777C							
HOIST							
	8J8924		I-UB-10	5-1/2	9-1/2	CTC-8T1543	368.12
STEERING							
	8J9912		P-UB-10	2-3/8	4	CTC-8T1389	40.27

CATERPILLAR®



REPLACEMENT KITS FOR CATERPILLAR® EQUIPMENT

Off-Highway Trucks							
APPLICATION	CYL #	Misc-Parts, Instructions, etc.	CODE	ROD	BORE	KIT #	List \$
MODEL 777C							
SUSPENSION FRONT							
	4T4756		I, P-U-3	9	10-3/4	CTC-1137463	1593.80
SUSPENSION REAR							
			P-UB-1	9	10-1/2	CTC-2959885	223.16
	8J8865		I, P-U-13	9	10-1/2	CTC-1137482	302.00
MODEL 777D							
HOIST							
			I-UB-10	5-1/2	9-1/2	CTC-3170942	309.62
	8J8924		I-UB-10	5-1/2	9-1/2	CTC-8T1543	368.12
STEERING							
	1052440		I-UB-10	2-1/2	3-1/2	CTC-3E3299	113.42
	8J9912		P-UB-10	2-3/8	4	CTC-8T1389	40.27
SUSPENSION FRONT							
	4T4756		I, P-U-3	9	10-3/4	CTC-1137463	1593.80
SUSPENSION REAR							
			P-UB-1	9	10-1/2	CTC-2959885	223.16
	8J8865		I, P-U-13	9	10-1/2	CTC-1137482	302.00
MODEL 777F							
HOIST							
			I-UB-10	5-1/2	7-1/2	CTC-2950145	215.64
STEERING							
			P-UB-10	2-1/2	3-1/2	CTC-2949583	59.35
SUSPENSION FRONT							
			P-UB-1	9	10-3/4	CTC-3087849	1419.08
SUSPENSION REAR							
			P-U-1	9	10-1/2	CTC-2976849	331.77
MODEL 783B							
HOIST							
		Includes extra parts	I-SP-10, 3	7-1/4, 10-1/2	9-1/4, 11-1/2	CTC-715438	622.71
			I-SP-10, 3	7-1/4, 10-1/2	9-1/4, 11-1/2	CTC-8T4939	654.05
STEERING							
			P-UB-10	2-1/2	5	CTC-1304012	161.86
		Serial# 8GB1-316	P-UB-10	2-1/2	5	CTC-7X2658	147.39
SUSPENSION FRONT							
		Combination kit	I, P-U-3	11	13-1/8	CTC-1137476	1357.38
		Insert wiper kit	I-U-3	11	13-1/8	CTC-711436	1015.77
		Press-in wiper kit	P-U-3	11	13-1/8	CTC-712436	1085.86
SUSPENSION REAR							
		Head# 1U4636, 1060856, 1072858	I, P-U-3	11	12-1/2	CTC-1565209	487.56
		Head# 1U4636	I-U-3	11	12-1/2	CTC-713437	350.55
		Head# 1060856, 1072858	P-U-3	11	12-1/2	CTC-714437	374.87
UNSPECIFIED APPLICATION							
	1072860		I, P-U-3	11	12-1/2	CTC-1565209	487.56
	4T5931		I-SP-10, 3	7-1/4, 10-1/2	9-1/4, 11-1/2	CTC-8T4939	654.05



REPLACEMENT KITS FOR CATERPILLAR® EQUIPMENT

Off-Highway Trucks							
APPLICATION	CYL #	Misc-Parts, Instructions, etc.	CODE	ROD	BORE	KIT #	List \$
MODEL 784B, 784C							
SUSPENSION REAR							
		Head# 1U4636, 1060856, 1072858	I, P-U-3	11	12-1/2	CTC-1565209	487.56
		Head# 1U4636	I-U-3	11	12-1/2	CTC-713437	350.55
		Head# 1060856, 1072858	P-U-3	11	12-1/2	CTC-714437	374.87
MODEL 785, 785B, 785C							
HOIST							
		Includes extra parts	I-SP-10, 3	7-1/4, 10-1/2	9-1/4, 11-1/2	CTC-715438	622.71
			I-SP-10, 3	7-1/4, 10-1/2	9-1/4, 11-1/2	CTC-8T4939	654.05
STEERING							
			P-UB-10	2-1/2	5	CTC-1304012	161.86
			P-UB-10	2-1/2	5	CTC-7X2658	147.39
SUSPENSION FRONT							
		Combination kit	I, P-U-3	11	13-1/8	CTC-1137476	1357.38
		Insert wiper kit	I-U-3	11	13-1/8	CTC-711436	1015.77
		Press-in wiper kit	P-U-3	11	13-1/8	CTC-712436	1085.86
SUSPENSION REAR							
		Head# 1U4636, 1060856, 1072858	I, P-U-3	11	12-1/2	CTC-1565209	487.56
		Head# 1U4636	I-U-3	11	12-1/2	CTC-713437	350.55
		Head# 1060856, 1072858	P-U-3	11	12-1/2	CTC-714437	374.87
UNSPECIFIED APPLICATION							
	1072860		I, P-U-3	11	12-1/2	CTC-1565209	487.56
	1U4651	785B, 785C	I, P-U-3	11	12-1/2	CTC-1565209	487.56
	4T5931	785C	I-SP-10, 3	7-1/4, 10-1/2	9-1/4, 11-1/2	CTC-8T4939	654.05
MODEL 786							
STEERING							
	7J9718		P-UB-10	2-1/4	5	CTC-7X2729	137.33
	7J9984		P-UB-10	2-1/4	5	CTC-7X2729	137.33
TILT LH							
	7J9762		P-UB-10	2-3/4	6-1/2	CTC-7X2689	136.20
TILT RH							
	7J9761		P-UB-10	2-3/4	6-1/2	CTC-7X2689	136.20
MODEL 787B							
SUSPENSION							
	1061801		I, P-U-3	12-1/2	14-1/4	CTC-1137480	767.53
UNSPECIFIED APPLICATION							
	9T2807		I-SP-10, 3	7-1/4, 11	9-1/2, 12-1/4	CTC-8C5788	894.07
MODEL 789, 789B, 789C							
HOIST							
			I-SP-10, 3	7-1/4, 11	9-1/2, 12-1/4	CTC-716439	636.82
		Includes rod wear rings	I-SP-10, 3	7-1/4, 11	9-1/2, 12-1/4	CTC-8C5788	894.07
STEERING							
			P-UB-10	2-3/4	6	CTC-2440953	86.66
SUSPENSION FRONT							
		Combination kit	I, P-U-3	12-1/2	15-1/8	CTC-1131073	1651.11
		Insert wiper kit	I-U-3	12-1/2	15-1/8	CTC-717440	1468.39
		Press-in wiper kit	P-U-3	12-1/2	15-1/8	CTC-718440	1468.18

CATERPILLAR®



REPLACEMENT KITS FOR CATERPILLAR® EQUIPMENT

Off-Highway Trucks							
APPLICATION	CYL #	Misc-Parts, Instructions, etc.	CODE	ROD	BORE	KIT #	List \$
MODEL 789, 789B, 789C							
SUSPENSION REAR							
		Head# 4T4761, 1060904, 1061807, 1591977	I, P-U-3	12-1/2	14-1/4	CTC-1137480	767.53
		Head# 4T4761	I-U-3	12-1/2	14-1/4	CTC-719441	618.55
		Head# 1060904, 1061807, 1591977	P-U-3	12-1/2	14-1/4	CTC-720441	508.26
UNSPECIFIED APPLICATION							
	1061801	789C	I, P-U-3	12-1/2	14-1/4	CTC-1137480	767.53
	4T4844	789B, 789C	I, P-U-3	12-1/2	14-1/4	CTC-1137480	767.53
	9T2807	789C	I-SP-10, 3	7-1/4, 11	9-1/2, 12-1/4	CTC-8C5788	894.07
MODEL 793, 793B							
HOIST							
			I-SP-10, 3	8-3/4, 12-1/2	11, 13-3/4	CTC-1125343	729.65
STEERING							
			P-UB-10	2-3/4	5-1/2	CTC-2601518	104.07
SUSPENSION FRONT							
		Combination kit	I, P-U-3	13-1/2	16-1/8	CTC-1137472	1631.50
		Insert wiper kit	I-U-3	13-1/2	16-1/8	CTC-7751023	1436.60
		Press-in wiper kit	P-U-3	13-1/2	16-1/8	CTC-7761023	1414.33
SUSPENSION REAR							
		Head# 4T4761, 1060904, 1061807, 1591977	I, P-U-3	12-1/2	14-1/4	CTC-1137480	767.53
			I, P-U-3	12-1/2	14-1/4	CTC-1137480	767.53
		Head# 4T4761	I-U-3	12-1/2	14-1/4	CTC-719441	618.55
		Head# 1060904, 1061807, 1591977	P-U-3	12-1/2	14-1/4	CTC-720441	508.26
		Head# 1946859; kit includes rod wear ring	P-U-3	12-1/2	14-1/4	CTC-778441	1176.45
MODEL 793C							
HOIST							
			I-SP-10, 3	7-3/4, 11-1/2	10, 12-1/2	CTC-1531282	579.18
STEERING							
			P-UB-10	2-3/4	5-1/2	CTC-2601518	104.07
SUSPENSION FRONT							
		Combination kit	I, P-U-3	13-1/2	16-1/8	CTC-1137472	1631.50
		Insert wiper kit	I-U-3	13-1/2	16-1/8	CTC-7751023	1436.60
		Press-in wiper kit	P-U-3	13-1/2	16-1/8	CTC-7761023	1414.33
SUSPENSION REAR							
		Head# 4T4761, 1060904, 1061807, 1591977	I, P-U-3	12-1/2	14-1/4	CTC-1137480	767.53
		Head# 4T4761	I-U-3	12-1/2	14-1/4	CTC-719441	618.55
		Head# 1060904, 1061807, 1591977	P-U-3	12-1/2	14-1/4	CTC-720441	508.26
UNSPECIFIED APPLICATION							
	6E1101		I, P-U-3	12-1/2	14-1/4	CTC-1137480	767.53
Pipelayers							
APPLICATION	CYL #	Misc-Parts, Instructions, etc.	CODE	ROD	BORE	KIT #	List \$
MODEL 561B							
COUNTERWEIGHT LH							
	3G3504		P-UB-10	2	4-1/2	CTC-7X2768	75.01



REPLACEMENT KITS FOR CATERPILLAR® EQUIPMENT

Pipelayers							
APPLICATION	CYL #	Misc-Parts, Instructions, etc.	CODE	ROD	BORE	KIT #	List \$
MODEL 561B							
COUNTERWEIGHT RH							
	3G3505		P-UB-10	2	4-1/2	CTC-7X2768	75.01
MODEL 561C, 561D							
COUNTERWEIGHT LH							
	3G3504		P-UB-10	2	4-1/2	CTC-7X2768	75.01
COUNTERWEIGHT RH							
	3G3505		P-UB-10	2	4-1/2	CTC-7X2768	75.01
TRACK ADJUSTER							
			TRK ADJ			CTC-FIG4400	40.63
MODEL 571A, 571F, 571G							
TRACK ADJUSTER							
			TRK ADJ			CTC-FIG3401	47.23
MODEL 572C, 572D, 572E, 572F							
TRACK ADJUSTER							
			TRK ADJ			CTC-FIG2400	64.99
			TRK ADJ			CTC-FIG3401	47.23
MODEL 572G							
DOZER LIFT LH							
	1U2136		P-UB-10	2-1/2	4-3/4	CTC-7X2660	151.93
DOZER LIFT RH							
	1U2135		P-UB-10	2-1/2	4-3/4	CTC-7X2660	151.93
TRACK ADJUSTER							
			TRK ADJ			CTC-FIG2400	64.99
			TRK ADJ			CTC-FIG3401	47.23
MODEL 578							
COUNTERWEIGHT							
	3G2918		P-V-10	2	4-1/2	CTC-7X2700	60.03
	9T0489		P-V-10	2	4-1/2	CTC-7X2700	60.03
MODEL 583H, 583K							
SIDE DUMP							
	8J5670		P-UB-10	2	4	CTC-7X2755	115.58
	8J5670		P-UB-10	2	4	CTC-7X7937	126.05
TRACK ADJUSTER							
			TRK ADJ			CTC-FIG1401	86.03
			TRK ADJ			CTC-FIG1402	102.01
MODEL 583R							
COUNTERWEIGHT							
	1333850		P-UB-10	2-1/8	4	CTC-1305923	134.10
MODEL 589							
COUNTERWEIGHT							
	3G2918		P-V-10	2	4-1/2	CTC-7X2700	60.03
MODEL 591							
COUNTERWEIGHT							
	3G9729		P-V-10	2	4-1/2	CTC-7X2700	60.03
MODEL 594, 594H							
LIFT							
	6J0416		P-V-10	2	5	CTC-7X2763	114.58

CATERPILLAR®



REPLACEMENT KITS FOR CATERPILLAR® EQUIPMENT

Pipelayers							
APPLICATION	CYL #	Misc-Parts, Instructions, etc.	CODE	ROD	BORE	KIT #	List \$
MODEL 594, 594H							
TRACK ADJUSTER							
			TRK ADJ			CTC-FIG0401	79.31
			TRK ADJ			CTC-FIG0402	93.45
MODEL MD7, MD8, MDW8							
COUNTERWEIGHT							
	3G3505		P-UB-10	2	4-1/2	CTC-7X2768	75.01
Scrapers							
APPLICATION	CYL #	Misc-Parts, Instructions, etc.	CODE	ROD	BORE	KIT #	List \$
MODEL 611							
BOWL							
	3G5679		P-UB-10	2-1/4	5	CTC-9X6392	135.36
LOAD							
	3G7274		P-UB-10	2-1/4	4-3/4	CTC-1318778	118.51
STEERING							
	6E3566		P-UB-10	2-1/4	4-1/2	CTC-1354392	118.74
MODEL 613							
BOWL LIFT							
	7J6058		P-UB-10	2	4	CTC-7X2755	115.58
EJECTOR							
	1U2012		P-UB-10	2-1/4	3-1/2	CTC-7X2818	76.31
FLOOR							
	7J5528		P-UB-10	2-1/2	5	CTC-7X2675	105.11
STEERING							
	7J6054		P-UB-10	2	4	CTC-7X2755	115.58
MODEL 613B							
BOWL LIFT							
	7J6058		P-UB-10	2	4	CTC-7X2755	115.58
EJECTOR							
	1U2012		P-UB-10	2-1/4	3-1/2	CTC-7X2818	76.31
FLOOR							
	7J5528		P-UB-10	2-1/2	5	CTC-7X2675	105.11
STEERING							
	1U2291		P-UB-10	2	4	CTC-1328816	78.46
	6E2968		P-UB-10	2	3-1/2	CTC-7X2783	87.11
	7J6054		P-UB-10	2	4	CTC-7X2755	115.58
	9T7900		P-UB-10	2	4	CTC-1328816	78.46
MODEL 613C							
BOWL LIFT							
	1U3124		P-UB-10	2	4	CTC-7X2789	86.29
EJECTOR							
	1U2012		P-UB-10	2-1/4	3-1/2	CTC-7X2818	76.31
FLOOR							
	1U2157		P-UB-10	2-1/2	5	CTC-7X2658	147.39
STEERING							
	1U2291		P-UB-10	2	4	CTC-7X2789	86.29



REPLACEMENT KITS FOR CATERPILLAR® EQUIPMENT

Scrapers							
APPLICATION	CYL #	Misc-Parts, Instructions, etc.	CODE	ROD	BORE	KIT #	List \$
MODEL 613SC							
BOWL							
	1U3124		P-UB-10	2	4	CTC-1328816	78.46
	3G5679		P-UB-10	2-1/4	5	CTC-9X6392	135.36
	7J6058		P-UB-10	2	4	CTC-7X2755	115.58
	9T8252		P-UB-10	2	4	CTC-1328816	78.46
EJECTOR							
	1U2012		P-UB-10	2-1/4	3-1/2	CTC-1358166	145.07
FLOOR							
	1U2157		P-UB-10	2-1/2	5	CTC-1315118	150.48
MODEL 615							
BOWL							
	3G5679		P-UB-10	2-1/4	5	CTC-9X6392	135.36
CUSHION HITCH							
	3G7274		P-UB-10	2-1/4	4-3/4	CTC-8T2216	66.53
DOOR							
	3G3883		P-UB-10	2-3/4	5-1/2	CTC-7X2690	84.20
EJECTOR							
	3G3892		P-UB-10	2-1/2	4-1/4	CTC-7X2663	41.78
LOAD							
	3G7274		P-UB-10	2-1/4	4-3/4	CTC-1318778	118.51
STEERING							
	5J1326		P-UB-10	2-1/4	5	CTC-7X2729	137.33
MODEL 615C							
BOWL LIFT							
	3G5679		P-UB-10	2-1/4	5	CTC-7X2729	137.33
DOOR							
	3G3883		P-UB-10	2-3/4	5-1/2	CTC-7X2690	84.20
EJECTOR							
	3G3892		P-UB-10	2-1/2	4-1/4	CTC-7X2663	41.78
LIFT							
	7J9902		P-UB-10	2	4-1/4	CTC-7X2819	88.92
LOAD							
	3G7274		P-UB-10	2-1/4	4-3/4	CTC-1318778	118.51
STEERING							
	5J1326		P-UB-10	2-1/4	5	CTC-7X2729	137.33
	6E2968		P-UB-10	2	3-1/2	CTC-7X2783	87.11
	6E3566		P-UB-10	2-1/4	4-1/2	CTC-1354392	118.74
MODEL 615SC							
BOWL							
	3G5679		P-UB-10	2-1/4	5	CTC-7X2729	137.33
	3G5679		P-UB-10	2-1/4	5	CTC-9X6392	135.36
EJECTOR							
	3G3892		P-UB-10	2-1/2	4-1/4	CTC-7X2663	41.78
STEERING							
	5J1326		P-UB-10	2-1/4	5	CTC-7X2729	137.33

CATERPILLAR®



REPLACEMENT KITS FOR CATERPILLAR® EQUIPMENT

Scrapers							
APPLICATION	CYL #	Misc-Parts, Instructions, etc.	CODE	ROD	BORE	KIT #	List \$
MODEL 621							
APRON							
	5J0778		P-UB-10	2-3/4	7-1/4	CTC-7X2681	96.09
BOWL LH							
	5J2450		P-UB-10	2-1/2	6	CTC-7X2662	144.88
BOWL RH							
	5J2449		P-UB-10	2-1/2	6	CTC-7X2662	144.88
EJECTOR							
	1U0408		P-UB-10	4	6-1/2	CTC-7X2765	199.38
	6J9689		P-UB-10	4	6-1/2	CTC-7X2765	199.38
FLOOR							
	7J5528		P-UB-10	2-1/2	5	CTC-7X2675	105.11
LOAD							
	8J0204		P-UB-10	2-1/2	5-1/2	CTC-9X2050	85.17
LOAD CUSHION HITCH							
	8J0204		P-UB-10	2-1/2	5-1/2	CTC-8T1374	79.00
	9J0537		P-UB-10	2-1/2	6-1/2	CTC-8T1376	67.29
	9J0537		P-SP-10	2-1/2	6-1/2	CTC-9X6024	129.79
	9T1803		P-UB-10	2-1/2	5-1/2	CTC-7X2653	137.42
STEERING							
	5J1326		P-UB-10	2-1/4	5	CTC-7X2729	137.33
MODEL 621B							
APRON							
	5J0778		P-UB-10	2-3/4	7-1/4	CTC-7X2681	96.09
BOWL LIFT							
	5J2449		P-UB-10	2-1/2	6	CTC-7X2662	144.88
	5J2450		P-UB-10	2-1/2	6	CTC-7X2662	144.88
EJECTOR							
	1U0408		P-UB-10	4	6-1/2	CTC-7X2765	199.38
	6J9573		P-UB-10	4	6-1/2	CTC-7X2765	199.38
LOAD							
	8J9446		P-UB-10	2-1/2	5-1/2	CTC-7X2653	137.42
	8J9446		P-UB-10	2-1/2	5-1/2	CTC-8T1374	79.00
	8J9446		P-UB-10	2-1/2	5-1/2	CTC-9X2050	85.17
STEERING							
	3G5192	1.11" wide wear ring, rod bearing incl	P-UB-10	2-1/2	5	CTC-1304012	161.86
	3G5192	1.55" wide wear ring	P-UB-10	2-1/2	5	CTC-7X2743	95.04
	5J1326		P-UB-10	2-1/4	5	CTC-7X2729	137.33
	8J7376		P-UB-10	2-1/2	5	CTC-1315106	142.87
MODEL 621E							
APRON							
	5J0778		P-UB-10	2-3/4	7-1/4	CTC-7X2681	96.09
BOWL LIFT							
	5J2449		P-UB-10	2-1/2	6	CTC-7X2662	144.88
	5J2450		P-UB-10	2-1/2	6	CTC-7X2662	144.88



REPLACEMENT KITS FOR CATERPILLAR® EQUIPMENT

Scrapers							
APPLICATION	CYL #	Misc-Parts, Instructions, etc.	CODE	ROD	BORE	KIT #	List \$
MODEL 621E							
EJECTOR							
	1U0408		P-UB-10	4	6-1/2	CTC-7X2765	199.38
	9T4885		P-UB-10	4	6-1/2	CTC-7X2765	199.38
LOAD							
	1083592		P-UB-10	2-1/2	5-1/2	CTC-7X2653	137.42
	9T1803		P-UB-10	2-1/2	5-1/2	CTC-7X2653	137.42
	9T1803		P-UB-10	2-1/2	5-1/2	CTC-8T1374	79.00
STEERING							
	3G5192	1.55" wide wear ring, rod bearing incl	P-UB-10	2-1/2	5	CTC-7X2658	147.39
	4T9364		P-UB-10	2-1/4	5	CTC-7X2729	137.33
	5J1326		P-UB-10	2-1/4	5	CTC-7X2729	137.33
MODEL 621F							
LOAD							
	1083592		P-UB-10	2-1/2	5-1/2	CTC-7X2653	137.42
STEERING							
	3G5192	1.11" wide wear ring, rod bearing incl	P-UB-10	2-1/2	5	CTC-1304012	161.86
	5J1326		P-UB-10	2-1/4	5	CTC-7X2729	137.33
MODEL 621G							
LOAD							
	1083592		P-UB-10	2-1/2	5-1/2	CTC-7X2653	137.42
MODEL 621R							
STEERING							
	3G5192	1.11" wide wear ring, rod bearing incl	P-UB-10	2-1/2	5	CTC-1304012	161.86
	3G5192	1.55" wide wear ring	P-UB-10	2-1/2	5	CTC-7X2743	95.04
MODEL 621S							
APRON							
	5J0778		P-UB-10	2-3/4	7-1/4	CTC-7X2681	96.09
	6E3690		P-UB-10	2-3/4	7-1/4	CTC-7X2681	96.09
BOWL LH							
	5J2450		P-UB-10	2-1/2	6	CTC-7X2662	144.88
BOWL RH							
	5J2449		P-UB-10	2-1/2	6	CTC-7X2662	144.88
EJECTOR							
	1U0408		P-UB-10	4	6-1/2	CTC-7X2765	199.38
STEERING							
	3G5192	1.11" wide wear ring, rod bearing incl	P-UB-10	2-1/2	5	CTC-1304012	161.86
MODEL 621SC							
APRON							
	5J0778		P-UB-10	2-3/4	7-1/4	CTC-7X2681	96.09
	6E3690		P-UB-10	2-3/4	7-1/4	CTC-7X2681	96.09
BOWL LH							
	5J2450		P-UB-10	2-1/2	6	CTC-7X2662	144.88
BOWL RH							
	5J2449		P-UB-10	2-1/2	6	CTC-7X2662	144.88

CATERPILLAR®



REPLACEMENT KITS FOR CATERPILLAR® EQUIPMENT

Scrapers							
APPLICATION	CYL #	Misc-Parts, Instructions, etc.	CODE	ROD	BORE	KIT #	List \$
MODEL 621SC							
EJECTOR							
	1U0408		P-UB-10	4	6-1/2	CTC-7X2765	199.38
	6J9689		P-UB-10	4	6-1/2	CTC-7X2765	199.38
	9T4885		P-UB-10	4	6-1/2	CTC-7X2765	199.38
LOAD							
	8J0204		P-UB-10	2-1/2	5-1/2	CTC-9X2050	85.17
STEERING							
	3G5192	1.11" wide wear ring, rod bearing incl	P-UB-10	2-1/2	5	CTC-1304012	161.86
	3G5192	1.55" wide wear ring	P-UB-10	2-1/2	5	CTC-7X2743	95.04
	5J1326		P-UB-10	2-1/4	5	CTC-7X2729	137.33
MODEL 623							
EJECTOR							
	8J5478		P-UB-10	2-1/2	5	CTC-1304012	161.86
	8J5478		P-UB-10	2-1/2	5	CTC-7X2658	147.39
FLOOR							
	8J1821		P-UB-10	3	6	CTC-7X2698	157.60
LIFT							
	8J1876		P-UB-10	2-1/2	6	CTC-7X2662	144.88
LOAD							
	8J0204		P-UB-10	2-1/2	5-1/2	CTC-8T1374	79.00
	8J0204		P-UB-10	2-1/2	5-1/2	CTC-9X2050	85.17
	9J0537		P-UB-10	2-1/2	6-1/2	CTC-8T1376	67.29
	9J0537		P-SP-10	2-1/2	6-1/2	CTC-9X6024	129.79
	9T1803		P-UB-10	2-1/2	5-1/2	CTC-7X2653	137.42
STEERING							
	5J1326		P-UB-10	2-1/4	5	CTC-7X2729	137.33
MODEL 623B							
BOWL LIFT							
	8J1876		P-UB-10	2-1/2	6	CTC-7X2662	144.88
EJECTOR							
	8J5478		P-UB-10	2-1/2	5	CTC-7X2658	147.39
FLOOR							
	8J1821		P-UB-10	3	6	CTC-7X2698	157.60
LOAD							
	8J9446		P-UB-10	2-1/2	5-1/2	CTC-7X2653	137.42
	8J9446		P-UB-10	2-1/2	5-1/2	CTC-8T1374	79.00
STEERING							
	3G5192	1.11" wide wear ring, rod bearing incl	P-UB-10	2-1/2	5	CTC-1304012	161.86
	3G5192	1.55" wide wear ring, rod bearing incl	P-UB-10	2-1/2	5	CTC-7X2658	147.39
	3G5192	1.55" wide wear ring	P-UB-10	2-1/2	5	CTC-7X2743	95.04
	8J7376		P-UB-10	2-1/2	5	CTC-1315106	142.87
WAGON DOOR							
	3G4640		P-UB-10	2-1/2	6	CTC-7X2669	197.74



REPLACEMENT KITS FOR CATERPILLAR® EQUIPMENT

Scrapers							
APPLICATION	CYL #	Misc-Parts, Instructions, etc.	CODE	ROD	BORE	KIT #	List \$
MODEL 623E							
BOWL LIFT							
	8J1876		P-UB-10	2-1/2	6	CTC-7X2662	144.88
EJECTOR							
	8J5478		P-UB-10	2-1/2	5	CTC-7X2658	147.39
	9T4886		P-UB-10	4-1/2	6	CTC-8C6958	219.00
FLOOR							
	8J1821		P-UB-10	3	6	CTC-7X2698	157.60
LOAD							
	1083592		P-UB-10	2-1/2	5-1/2	CTC-7X2653	137.42
	9T1803		P-UB-10	2-1/2	5-1/2	CTC-7X2653	137.42
	9T1803		P-UB-10	2-1/2	5-1/2	CTC-8T1374	79.00
STEERING							
	3G5192	1.55" wide wear ring, rod bearing incl	P-UB-10	2-1/2	5	CTC-7X2658	147.39
MODEL 623F, 623G							
LOAD							
	1083592		P-UB-10	2-1/2	5-1/2	CTC-7X2653	137.42
MODEL 623SC							
EJECTOR							
	8J5478		P-UB-10	2-1/2	5	CTC-1304012	161.86
	8J5478		P-UB-10	2-1/2	5	CTC-7X2658	147.39
FLOOR							
	8J1821		P-UB-10	3	6	CTC-7X2698	157.60
LIFT							
	8J1876		P-UB-10	2-1/2	6	CTC-7X2662	144.88
LOAD							
	8J0204		P-UB-10	2-1/2	5-1/2	CTC-9X2050	85.17
STEERING							
	3G5192	1.11" wide wear ring, rod bearing incl	P-UB-10	2-1/2	5	CTC-1304012	161.86
	3G5192	1.55" wide wear ring	P-UB-10	2-1/2	5	CTC-7X2743	95.04
	5J1326		P-UB-10	2-1/4	5	CTC-7X2729	137.33
MODEL 623SCG							
EJECTOR							
	8J5478		P-UB-10	2-1/2	5	CTC-1304012	161.86
LIFT							
	8J1876		P-UB-10	2-1/2	6	CTC-7X2662	144.88
STEERING							
	3G5192	1.11" wide wear ring, rod bearing incl	P-UB-10	2-1/2	5	CTC-1304012	161.86
MODEL 627							
APRON							
	5J0778		P-UB-10	2-3/4	7-1/4	CTC-7X2681	96.09
BAIL							
	4T5638		P-UB-10	1-3/4	3	CTC-7X2791	74.94
	8J6064		P-U-10	2	3-1/2	CTC-7X2806	102.63

CATERPILLAR®



REPLACEMENT KITS FOR CATERPILLAR® EQUIPMENT

Scrapers							
APPLICATION	CYL #	Misc-Parts, Instructions, etc.	CODE	ROD	BORE	KIT #	List \$
MODEL 627							
BOWL LH							
	5J2450	Incl. Buffer & Rod Brg - Wear Ring 1.74"	P-UB-10	2-1/2	6	CTC-7X2662	144.88
BOWL LIFT							
	5J2449	Piston # C9J8047 - Wear Ring 1.74"	P-V-10	2-1/2	6	CTC-514131	103.67
	5J2450	Piston # C9J8047 - Wear Ring 1.74"	P-V-10	2-1/2	6	CTC-514131	103.67
BOWL RH							
	5J2449	Incl. Buffer & Rod Brg - Wear Ring 1.74"	P-UB-10	2-1/2	6	CTC-7X2662	144.88
EJECTOR							
	1U0408		P-UB-10	4	6-1/2	CTC-7X2765	199.38
LOAD							
	8J0204		P-UB-10	2-1/2	5-1/2	CTC-9X2050	85.17
LOAD CUSHION HITCH							
	8J0204		P-UB-10	2-1/2	5-1/2	CTC-8T1374	79.00
	9J0537		P-UB-10	2-1/2	6-1/2	CTC-8T1376	67.29
	9J0537		P-SP-10	2-1/2	6-1/2	CTC-9X6024	129.79
	9T1803		P-UB-10	2-1/2	5-1/2	CTC-7X2653	137.42
STEERING							
	5J1326		P-UB-10	2-1/4	5	CTC-7X2729	137.33
MODEL 627B							
APRON							
	5J0778		P-UB-10	2-3/4	7-1/4	CTC-7X2681	96.09
BAIL							
	8J6064		P-U-10	2	3-1/2	CTC-7X2806	102.63
	8J8458		P-UB-10	1-1/2	3-1/2	CTC-7X2752	80.70
BOWL LIFT							
	5J2449	Piston # C9J8047 - Wear Ring 1.74"	P-V-10	2-1/2	6	CTC-514131	103.67
	5J2449	Incl. Buffer & Rod Brg - Wear Ring 1.74"	P-UB-10	2-1/2	6	CTC-7X2662	144.88
	5J2449	Piston # C5J0968 - Wear Ring 1.31"	P-UB-10	2-1/2	6	CTC-7X2679	116.87
	5J2450	Piston # C9J8047 - Wear Ring 1.74"	P-V-10	2-1/2	6	CTC-514131	103.67
	5J2450	Incl. Buffer & Rod Brg - Wear Ring 1.74"	P-UB-10	2-1/2	6	CTC-7X2662	144.88
	5J2450	Incl. Buffer & Rod Brg - Wear Ring 1.74"	P-UB-10	2-1/2	6	CTC-7X2662	144.88
	5J2450	Piston # C9J8047 - Wear Ring 1.31"	P-UB-10	2-1/2	6	CTC-7X2679	116.87
EJECTOR							
	1U0408		P-UB-10	4	6-1/2	CTC-7X2765	199.38
	6J9573		P-UB-10	4	6-1/2	CTC-7X2765	199.38
LOAD							
	8J9446		P-UB-10	2-1/2	5-1/2	CTC-7X2653	137.42
	8J9446		P-UB-10	2-1/2	5-1/2	CTC-8T1374	79.00



REPLACEMENT KITS FOR CATERPILLAR® EQUIPMENT

Scrapers							
APPLICATION	CYL #	Misc-Parts, Instructions, etc.	CODE	ROD	BORE	KIT #	List \$
MODEL 627B							
STEERING							
	3G5192	1.11" wide wear ring, rod bearing incl	P-UB-10	2-1/2	5	CTC-1304012	161.86
	3G5192	1.55" wide wear ring, rod bearing incl	P-UB-10	2-1/2	5	CTC-7X2658	147.39
	3G5192	1.55" wide wear ring	P-UB-10	2-1/2	5	CTC-7X2743	95.04
	5J1326		P-UB-10	2-1/4	5	CTC-7X2729	137.33
	8J7376		P-UB-10	2-1/2	5	CTC-1315106	142.87
MODEL 627E							
APRON							
	5J0778		P-UB-10	2-3/4	7-1/4	CTC-7X2681	96.09
BAIL							
	4T5638		P-UB-10	1-3/4	3	CTC-7X2791	74.94
BOWL LIFT							
	5J2449	Wear Ring 1.74"	P-UB-10	2-1/2	6	CTC-7X2662	144.88
	5J2450	Wear Ring 1.74"	P-UB-10	2-1/2	6	CTC-7X2662	144.88
EJECTOR							
	1U0408		P-UB-10	4	6-1/2	CTC-7X2765	199.38
	9T4885		P-UB-10	4	6-1/2	CTC-7X2765	199.38
LOAD							
	1083592		P-UB-10	2-1/2	5-1/2	CTC-7X2653	137.42
	9T1803		P-UB-10	2-1/2	5-1/2	CTC-7X2653	137.42
	9T1803		P-UB-10	2-1/2	5-1/2	CTC-8T1374	79.00
STEERING							
	3G5192	1.55" wide wear ring, rod bearing incl	P-UB-10	2-1/2	5	CTC-7X2658	147.39
	3G6904		P-UB-10	2-1/2	5	CTC-7X2658	147.39
	5J1326		P-UB-10	2-1/4	5	CTC-7X2729	137.33
MODEL 627F							
BAIL							
	6E0801		P-UB-10	1-3/4	3	CTC-7X2825	42.17
BOWL LIFT							
	5J2449	Wear Ring 1.74"	P-UB-10	2-1/2	6	CTC-7X2662	144.88
	5J2450	Wear Ring 1.74"	P-UB-10	2-1/2	6	CTC-7X2662	144.88
LOAD							
	1083592		P-UB-10	2-1/2	5-1/2	CTC-7X2653	137.42
MODEL 627G							
BOWL LIFT							
	5J2449	Wear Ring 1.74"	P-UB-10	2-1/2	6	CTC-7X2662	144.88
	5J2450	Wear Ring 1.74"	P-UB-10	2-1/2	6	CTC-7X2662	144.88
MODEL 627SC							
APRON							
	5J0778		P-UB-10	2-3/4	7-1/4	CTC-7X2681	96.09
	6E3690		P-UB-10	2-3/4	7-1/4	CTC-7X2681	96.09
BAIL							
	7J2377		P-U-10	2	3-1/2	CTC-7X2806	102.63
	8J6064		P-U-10	2	3-1/2	CTC-7X2806	102.63

CATERPILLAR®



REPLACEMENT KITS FOR CATERPILLAR® EQUIPMENT

Scrapers							
APPLICATION	CYL #	Misc-Parts, Instructions, etc.	CODE	ROD	BORE	KIT #	List \$
MODEL 627SC							
BOWL LH							
	5J2450		P-UB-10	2-1/2	6	CTC-7X2662	144.88
BOWL RH							
	5J2449		P-UB-10	2-1/2	6	CTC-7X2662	144.88
EJECTOR							
	1U0408		P-UB-10	4	6-1/2	CTC-7X2765	199.38
	9T4885		P-UB-10	4	6-1/2	CTC-7X2765	199.38
LOAD							
	8J0204		P-UB-10	2-1/2	5-1/2	CTC-9X2050	85.17
STEERING							
	3G5192	1.11" wide wear ring, rod bearing incl	P-UB-10	2-1/2	5	CTC-1304012	161.86
	3G5192	1.55" wide wear ring, rod bearing incl	P-UB-10	2-1/2	5	CTC-7X2658	147.39
	3G5192	1.55" wide wear ring	P-UB-10	2-1/2	5	CTC-7X2743	95.04
	5J1326		P-UB-10	2-1/4	5	CTC-7X2729	137.33
MODEL 630							
TRACTION CONTROL							
	4D0470		P-V-10	2	5	CTC-7X2763	114.58
	4D5543		P-V-10	2	5	CTC-7X2763	114.58
MODEL 630B							
BOWL							
	6J1983		P-UB-10	3	8-1/4	CTC-7X2695	300.68
EJECTOR							
	6J1419		I-U-10	6	8-1/4	CTC-1180672	553.86
	6J1419		P-V-10	6	8-1/4	CTC-8T1415	250.25
MODEL 630SC							
EJECTOR							
	6J1419		I-U-10	6	8-1/4	CTC-1180672	553.86
MODEL 631							
APRON							
	8J5931		P-UB-10	3	8-1/4	CTC-7X2695	300.68
LIFT RH							
	7J2395		P-UB-10	2-3/4	7-1/4	CTC-7X2687	225.35
LOAD							
	8J9959		P-UB-10	2-1/2	6-1/2	CTC-8T1376	67.29
MODEL 631B							
BOWL LIFT							
	3G9677		P-UB-10	2-3/4	7-1/4	CTC-7X2687	225.35
	7J2395		P-UB-10	2-3/4	7-1/4	CTC-7X2687	225.35
	7J2396		P-UB-10	2-3/4	7-1/4	CTC-7X2687	225.35
EJECTOR							
	6J1419		I-U-10	6	8-1/4	CTC-1180672	553.86
	6J1419		P-V-10	6	8-1/4	CTC-8T1415	250.25
LIFT							
	3G9677		P-UB-10	2-3/4	7-1/4	CTC-7X2687	225.35



REPLACEMENT KITS FOR CATERPILLAR® EQUIPMENT

Scrapers							
APPLICATION	CYL #	Misc-Parts, Instructions, etc.	CODE	ROD	BORE	KIT #	List \$
MODEL 631B							
LOAD CUSHION HITCH							
	9J0537		P-UB-10	2-1/2	6-1/2	CTC-8T1376	67.29
	9J0537		P-SP-10	2-1/2	6-1/2	CTC-9X6024	129.79
STEERING							
	3J9031		P-UB-10	2-1/2	6-1/2	CTC-8T1376	67.29
	5J1250		P-UB-10	2-1/2	6-1/2	CTC-8T1376	67.29
	5J7806		P-UB-10	2-1/2	6-1/2	CTC-8T1376	67.29
	5J8606		P-UB-10	2-1/2	6-1/2	CTC-1370264	148.50
	8J3544		P-UB-10	2-1/2	6-1/2	CTC-8T1376	67.29
STEERING RH							
	7J1693		P-UB-10	2-1/2	6-1/2	CTC-8T1376	67.29
MODEL 631C							
APRON							
	8J5931		P-UB-10	3	8-1/4	CTC-7X2695	300.68
BOWL LIFT							
	7J2395		P-UB-10	2-3/4	7-1/4	CTC-7X2687	225.35
	7J2396		P-UB-10	2-3/4	7-1/4	CTC-7X2687	225.35
EJECTOR							
	6J1419		I-U-10	6	8-1/4	CTC-1180672	553.86
	6J1419		P-V-10	6	8-1/4	CTC-8T1415	250.25
LIFT LH							
	7J2396		P-UB-10	2-3/4	7-1/4	CTC-7X2687	225.35
LIFT RH							
	7J2395		P-UB-10	2-3/4	7-1/4	CTC-7X2687	225.35
LOAD							
	7J3386		P-UB-14	2-1/2	6	CTC-7X2836	217.33
	9J0537		P-UB-10	2-1/2	6-1/2	CTC-8T1376	67.29
	9J0537		P-SP-10	2-1/2	6-1/2	CTC-9X6024	129.79
STEERING							
	5J7806		P-UB-10	2-1/2	6-1/2	CTC-8T1376	67.29
MODEL 631D							
APRON							
	8J5931		P-UB-10	3	8-1/4	CTC-7X2695	300.68
EJECTOR							
	6J1419		I-U-10	6	8-1/4	CTC-1180672	553.86
	6J1419		P-V-10	6	8-1/4	CTC-8T1415	250.25
	6J5824		P-V-10	6	8-1/4	CTC-8T1415	250.25
LIFT LH							
	9J0409		P-UB-10	2-3/4	7-1/4	CTC-7X2687	225.35
LIFT RH							
	9J0408		P-UB-10	2-3/4	7-1/4	CTC-7X2687	225.35
LOAD							
	8J9959		P-UB-10	2-1/2	6-1/2	CTC-1370264	148.50
	8J9959		P-UB-10	2-1/2	6-1/2	CTC-8T1376	67.29
	8J9959		P-SP-10	2-1/2	6-1/2	CTC-9X6024	129.79

CATERPILLAR®



REPLACEMENT KITS FOR CATERPILLAR® EQUIPMENT

Scrapers							
APPLICATION	CYL #	Misc-Parts, Instructions, etc.	CODE	ROD	BORE	KIT #	List \$
MODEL 631D							
STEERING							
	3G7607		P-UB-10	2-3/4	6-1/2	CTC-7X2689	136.20
	8J9918		P-UB-10	2-3/4	6-1/2	CTC-7X2689	136.20
MODEL 631E							
APRON							
	8J5931		P-UB-10	3	8-1/4	CTC-7X2695	300.68
EJECTOR							
	6E0897		P-UB-10	3	8-1/4	CTC-7X2695	300.68
	6J5824		P-V-10	6	8-1/4	CTC-8T1415	250.25
	9T3595		I-U-10	6	8-1/4	CTC-1180672	553.86
	9T3595		P-V-10	6	8-1/4	CTC-8T1415	250.25
	9T4887		I-U-10	6	8-1/4	CTC-1180672	553.86
	9T4887		P-V-10	6	8-1/4	CTC-8T1415	250.25
LIFT RH							
	9J0408		P-UB-10	2-3/4	7-1/4	CTC-7X2687	225.35
LOAD							
	8J9959		P-UB-10	2-1/2	6-1/2	CTC-1370264	148.50
	8J9959		P-UB-10	2-1/2	6-1/2	CTC-8T1376	67.29
	8J9959		P-SP-10	2-1/2	6-1/2	CTC-9X6024	129.79
STEERING							
	3G7607		P-UB-10	2-3/4	6-1/2	CTC-7X2689	136.20
	5J7806		P-UB-10	2-1/2	6-1/2	CTC-8T1376	67.29
MODEL 631SC							
APRON							
	8J5931		P-UB-10	3	8-1/4	CTC-7X2695	300.68
EJECTOR							
	6E0897		I-U-10	6	8-1/4	CTC-1180672	553.86
	6E0905		I-U-10	6	8-1/4	CTC-1180672	553.86
	6J1419		I-U-10	6	8-1/4	CTC-1180672	553.86
	6J5824		I-U-10	6	8-1/4	CTC-1180672	553.86
	6J5824		P-V-10	6	8-1/4	CTC-8T1415	250.25
	9T3595		I-U-10	6	8-1/4	CTC-1180672	553.86
	9T4887		I-U-10	6	8-1/4	CTC-1180672	553.86
LIFT LH							
	7J2396		P-UB-10	2-3/4	7-1/4	CTC-7X2687	225.35
	9J0409		P-UB-10	2-3/4	7-1/4	CTC-7X2687	225.35
LIFT RH							
	7J2395		P-UB-10	2-3/4	7-1/4	CTC-7X2687	225.35
	9J0408		P-UB-10	2-3/4	7-1/4	CTC-7X2687	225.35
LOAD							
	7J3386		P-UB-14	2-1/2	6	CTC-7X2836	217.33
	9J0537		P-SP-10	2-1/2	6-1/2	CTC-9X6024	129.79
STEERING							
	3G7607		P-UB-10	2-3/4	6-1/2	CTC-7X2689	136.20
	3J9031		P-UB-10	2-1/2	6-1/2	CTC-8T1376	67.29
	5J1250		P-UB-10	2-1/2	6-1/2	CTC-8T1376	67.29
	5J7806		P-UB-10	2-1/2	6-1/2	CTC-8T1376	67.29



REPLACEMENT KITS FOR CATERPILLAR® EQUIPMENT

Scrapers							
APPLICATION	CYL #	Misc-Parts, Instructions, etc.	CODE	ROD	BORE	KIT #	List \$
MODEL 632							
BOWL LIFT							
	6J1983		P-UB-10	3	8-1/4	CTC-7X2695	300.68
EJECTOR							
	6J1419		I-U-10	6	8-1/4	CTC-1180672	553.86
	6J1419		P-V-10	6	8-1/4	CTC-8T1415	250.25
TRACTION CONTROL							
	4D0470		P-V-10	2	5	CTC-7X2763	114.58
	4D5543		P-V-10	2	5	CTC-7X2763	114.58
MODEL 633							
BOWL LIFT							
	3G9677		P-UB-10	2-3/4	7-1/4	CTC-7X2687	225.35
LIFT							
	3G9677		P-UB-10	2-3/4	7-1/4	CTC-7X2687	225.35
LOAD CUSHION HITCH							
	9J0537		P-UB-10	2-1/2	6-1/2	CTC-8T1376	67.29
	9J0537		P-SP-10	2-1/2	6-1/2	CTC-9X6024	129.79
STEERING							
	5J7806		P-UB-10	2-1/2	6-1/2	CTC-1370264	148.50
	5J7806		P-UB-10	2-1/2	6-1/2	CTC-8T1376	67.29
	8J3544		P-UB-10	2-1/2	6-1/2	CTC-8T1376	67.29
STEERING RH							
	7J1693		P-UB-10	2-1/2	6-1/2	CTC-8T1376	67.29
MODEL 633B							
BOWL LIFT							
	3G9677		P-UB-10	2-3/4	7-1/4	CTC-7X2687	225.35
LOAD CUSHION HITCH							
	9J0537		P-UB-10	2-1/2	6-1/2	CTC-8T1376	67.29
	9J0537		P-SP-10	2-1/2	6-1/2	CTC-9X6024	129.79
STEERING							
	5J7806		P-UB-10	2-1/2	6-1/2	CTC-8T1376	67.29
	6J1516		P-UB-10	2-1/2	6-1/2	CTC-8T1376	67.29
	8J3544		P-UB-10	2-1/2	6-1/2	CTC-8T1376	67.29
STEERING RH							
	7J1693		P-UB-10	2-1/2	6-1/2	CTC-8T1376	67.29
MODEL 633C							
BOWL LIFT							
	3G9677		P-UB-10	2-3/4	7-1/4	CTC-7X2687	225.35
LIFT							
	3G9677		P-UB-10	2-3/4	7-1/4	CTC-7X2687	225.35
LOAD							
	7J3386		P-UB-14	2-1/2	6	CTC-7X2836	217.33
	9J0537		P-UB-10	2-1/2	6-1/2	CTC-1370264	148.50
	9J0537		P-UB-10	2-1/2	6-1/2	CTC-8T1376	67.29
	9J0537		P-SP-10	2-1/2	6-1/2	CTC-9X6024	129.79

CATERPILLAR®



REPLACEMENT KITS FOR CATERPILLAR® EQUIPMENT

Scrapers							
APPLICATION	CYL #	Misc-Parts, Instructions, etc.	CODE	ROD	BORE	KIT #	List \$
MODEL 633C							
STEERING							
	5J7806		P-UB-10	2-1/2	6-1/2	CTC-1370264	148.50
	5J7806		P-UB-10	2-1/2	6-1/2	CTC-8T1376	67.29
	6J1516		P-UB-10	2-1/2	6-1/2	CTC-8T1376	67.29
	8J3544		P-UB-10	2-1/2	6-1/2	CTC-1370264	148.50
	8J3544		P-UB-10	2-1/2	6-1/2	CTC-8T1376	67.29
STEERING RH							
	7J1693		P-UB-10	2-1/2	6-1/2	CTC-8T1376	67.29
MODEL 633D							
BOWL LIFT							
	3G9677		P-UB-10	2-3/4	7-1/4	CTC-7X2687	225.35
	7J0243		P-UB-10	2-3/4	7-1/4	CTC-7X2687	225.35
EJECTOR							
	9T3595		I-U-10	6	8-1/4	CTC-1180672	553.86
	9T3595		P-V-10	6	8-1/4	CTC-8T1415	250.25
LOAD							
	8J9959		P-UB-10	2-1/2	6-1/2	CTC-1370264	148.50
	8J9959		P-UB-10	2-1/2	6-1/2	CTC-8T1376	67.29
	8J9959		P-SP-10	2-1/2	6-1/2	CTC-9X6024	129.79
STEERING							
	3G7607		P-UB-10	2-3/4	6-1/2	CTC-7X2689	136.20
	6J1516		P-UB-10	2-1/2	6-1/2	CTC-8T1376	67.29
	8J9918		P-UB-10	2-3/4	6-1/2	CTC-7X2689	136.20
STEERING RH							
	7J1693		P-UB-10	2-1/2	6-1/2	CTC-8T1376	67.29
MODEL 633SC							
BOWL							
	1313223		P-UB-10	2-3/4	7-1/4	CTC-7X2687	225.35
EJECTOR							
	1U0408		P-UB-10	4	6-1/2	CTC-7X2765	199.38
LIFT							
	3G9677		P-UB-10	2-3/4	7-1/4	CTC-7X2687	225.35
LOAD							
	7J3386		P-UB-14	2-1/2	6	CTC-7X2836	217.33
	9J1188		P-SP-10	2-1/2	6-1/2	CTC-9X6024	129.79
STEERING							
	5J7806		P-UB-10	2-1/2	6-1/2	CTC-8T1376	67.29
	6J1516		P-UB-10	2-1/2	6-1/2	CTC-8T1376	67.29
	8J3544		P-UB-10	2-1/2	6-1/2	CTC-8T1376	67.29
STEERING RH							
	7J1693		P-UB-10	2-1/2	6-1/2	CTC-8T1376	67.29
MODEL 637							
APRON							
	8J5931		P-UB-10	3	8-1/4	CTC-7X2695	300.68



REPLACEMENT KITS FOR CATERPILLAR® EQUIPMENT

Scrapers							
APPLICATION	CYL #	Misc-Parts, Instructions, etc.	CODE	ROD	BORE	KIT #	List \$
MODEL 637							
BAIL							
	4T5638		P-UB-10	1-3/4	3	CTC-7X2791	74.94
	7J2377		P-U-10	2	3-1/2	CTC-7X2806	102.63
	8J6064		P-U-10	2	3-1/2	CTC-7X2806	102.63
BOWL LIFT							
	7J2395		P-UB-10	2-3/4	7-1/4	CTC-7X2687	225.35
	7J2396		P-UB-10	2-3/4	7-1/4	CTC-7X2687	225.35
EJECTOR							
	6J5824		I-U-10	6	8-1/4	CTC-1180672	553.86
	6J5824		P-V-10	6	8-1/4	CTC-8T1415	250.25
LIFT LH							
	7J2396		P-UB-10	2-3/4	7-1/4	CTC-7X2687	225.35
LIFT RH							
	7J2395		P-UB-10	2-3/4	7-1/4	CTC-7X2687	225.35
LOAD							
	7J3386		P-UB-14	2-1/2	6	CTC-7X2836	217.33
	8J9959		P-UB-10	2-1/2	6-1/2	CTC-8T1376	67.29
	9J0537		P-UB-10	2-1/2	6-1/2	CTC-1370264	148.50
	9J0537		P-UB-10	2-1/2	6-1/2	CTC-8T1376	67.29
	9J0537		P-SP-10	2-1/2	6-1/2	CTC-9X6024	129.79
STEERING							
	5J7806		P-UB-10	2-1/2	6-1/2	CTC-1370264	148.50
	5J7806		P-UB-10	2-1/2	6-1/2	CTC-8T1376	67.29
MODEL 637B							
APRON							
	8J5931		P-UB-10	3	8-1/4	CTC-7X2695	300.68
BOWL LIFT							
	7J2395		P-UB-10	2-3/4	7-1/4	CTC-7X2687	225.35
	7J2396		P-UB-10	2-3/4	7-1/4	CTC-7X2687	225.35
EJECTOR							
	6J5824		P-V-10	6	8-1/4	CTC-8T1415	250.25
MODEL 637D							
APRON							
	8J5931		P-UB-10	3	8-1/4	CTC-7X2695	300.68
BAIL							
	8J6064		P-U-10	2	3-1/2	CTC-7X2806	102.63
	8J8458		P-UB-10	1-1/2	3-1/2	CTC-7X2752	80.70
EJECTOR							
	6J5824		P-V-10	6	8-1/4	CTC-8T1415	250.25
LIFT LH							
	9J0409		P-UB-10	2-3/4	7-1/4	CTC-7X2687	225.35
LIFT RH							
	9J0408		P-UB-10	2-3/4	7-1/4	CTC-7X2687	225.35
LOAD							
	8J9959		P-UB-10	2-1/2	6-1/2	CTC-1370264	148.50
	8J9959		P-UB-10	2-1/2	6-1/2	CTC-8T1376	67.29
	8J9959		P-SP-10	2-1/2	6-1/2	CTC-9X6024	129.79

CATERPILLAR®



REPLACEMENT KITS FOR CATERPILLAR® EQUIPMENT

Scrapers							
APPLICATION	CYL #	Misc-Parts, Instructions, etc.	CODE	ROD	BORE	KIT #	List \$
MODEL 637D							
STEERING							
	3G7607		P-UB-10	2-3/4	6-1/2	CTC-7X2689	136.20
	8J9918		P-UB-10	2-3/4	6-1/2	CTC-7X2689	136.20
MODEL 637E							
APRON							
	8J5931		P-UB-10	3	8-1/4	CTC-7X2695	300.68
BAIL							
	4T5638		P-UB-10	1-3/4	3	CTC-7X2791	74.94
EJECTOR							
	6J5824		P-V-10	6	8-1/4	CTC-8T1415	250.25
	9T3595		I-U-10	6	8-1/4	CTC-1180672	553.86
	9T3595		P-V-10	6	8-1/4	CTC-8T1415	250.25
	9T4887		I-U-10	6	8-1/4	CTC-1180672	553.86
	9T4887		P-V-10	6	8-1/4	CTC-8T1415	250.25
LIFT LH							
	9J0409		P-UB-10	2-3/4	7-1/4	CTC-7X2687	225.35
LIFT RH							
	9J0408		P-UB-10	2-3/4	7-1/4	CTC-7X2687	225.35
LOAD							
	8J9959		P-UB-10	2-1/2	6-1/2	CTC-1370264	148.50
	8J9959		P-UB-10	2-1/2	6-1/2	CTC-8T1376	67.29
	8J9959		P-SP-10	2-1/2	6-1/2	CTC-9X6024	129.79
STEERING							
	3G7607		P-UB-10	2-3/4	6-1/2	CTC-7X2689	136.20
MODEL 637SC							
APRON							
	8J5931		P-UB-10	3	8-1/4	CTC-7X2695	300.68
BAIL							
	7J2377		P-U-10	2	3-1/2	CTC-7X2806	102.63
	8J6064		P-U-10	2	3-1/2	CTC-7X2806	102.63
EJECTOR							
	6E0897		I-U-10	6	8-1/4	CTC-1180672	553.86
	6E0905		I-U-10	6	8-1/4	CTC-1180672	553.86
	6J5824		I-U-10	6	8-1/4	CTC-1180672	553.86
	6J5824		P-V-10	6	8-1/4	CTC-8T1415	250.25
	9T3595		I-U-10	6	8-1/4	CTC-1180672	553.86
	9T4887		I-U-10	6	8-1/4	CTC-1180672	553.86
LIFT LH							
	7J2396		P-UB-10	2-3/4	7-1/4	CTC-7X2687	225.35
	9J0409		P-UB-10	2-3/4	7-1/4	CTC-7X2687	225.35
LIFT RH							
	7J2395		P-UB-10	2-3/4	7-1/4	CTC-7X2687	225.35
	9J0408		P-UB-10	2-3/4	7-1/4	CTC-7X2687	225.35
LOAD							
	7J3386		P-UB-14	2-1/2	6	CTC-7X2836	217.33
	9J0537		P-SP-10	2-1/2	6-1/2	CTC-9X6024	129.79



REPLACEMENT KITS FOR CATERPILLAR® EQUIPMENT

Scrapers							
APPLICATION	CYL #	Misc-Parts, Instructions, etc.	CODE	ROD	BORE	KIT #	List \$
MODEL 637SC							
STEERING							
	3G7607		P-UB-10	2-3/4	6-1/2	CTC-7X2689	136.20
	5J7806		P-UB-10	2-1/2	6-1/2	CTC-8T1376	67.29
MODEL 639D							
BOWL LIFT							
	3G9677		P-UB-10	2-3/4	7-1/4	CTC-7X2687	225.35
EJECTOR							
	3G2949		P-UB-10	2-1/2	4-1/2	CTC-7X2667	80.82
LOAD							
	8J9959		P-UB-10	2-1/2	6-1/2	CTC-1370264	148.50
	8J9959		P-UB-10	2-1/2	6-1/2	CTC-8T1376	67.29
	8J9959		P-SP-10	2-1/2	6-1/2	CTC-9X6024	129.79
STEERING							
	3G7607		P-UB-10	2-3/4	6-1/2	CTC-7X2689	136.20
MODEL 639SC							
EJECTOR							
	3G2949		P-UB-10	2-1/2	4-1/2	CTC-7X2667	80.82
LIFT							
	3G9677		P-UB-10	2-3/4	7-1/4	CTC-7X2687	225.35
MODEL 641, 641B							
APRON							
	5J8117		P-UB-10	3-1/4	9-1/4	CTC-7X2708	172.39
BOWL LIFT							
	6J1983		P-UB-10	3	8-1/4	CTC-7X2695	300.68
BOWL LIFT LH							
	7J4364		P-UB-10	3	8-1/4	CTC-7X2695	300.68
BOWL LIFT RH							
	7J4363		P-UB-10	3	8-1/4	CTC-7X2695	300.68
CUSHION HITCH							
	7J4623		P-UB-10	3-1/2	8-1/4	CTC-7X2725	329.13
LOAD							
	5J8623		P-UB-10	3-1/2	8-1/4	CTC-7X2728	147.99
	7J4623	641B only	P-UB-10	3-1/2	8-1/4	CTC-7X2725	329.13
STEERING							
	3G9689		P-UB-10	2-3/4	7-1/4	CTC-7X2687	225.35
MODEL 641SC							
BOWL							
	6J1983		P-UB-10	3	8-1/4	CTC-7X2695	300.68
BOWL LH							
	7J4364		P-UB-10	3	8-1/4	CTC-7X2695	300.68
BOWL RH							
	7J4363		P-UB-10	3	8-1/4	CTC-7X2695	300.68
LOAD							
	5J8623		P-UB-10	3-1/2	8-1/4	CTC-7X2728	147.99
	7J4623		P-UB-10	3-1/2	8-1/4	CTC-7X2725	329.13

CATERPILLAR®



REPLACEMENT KITS FOR CATERPILLAR® EQUIPMENT

Scrapers							
APPLICATION	CYL #	Misc-Parts, Instructions, etc.	CODE	ROD	BORE	KIT #	List \$
MODEL 650, 650B							
BOWL LIFT LH							
	7J4356		P-UB-10	3-1/4	9-1/4	CTC-7X2716	135.00
	7J4406		P-UB-10	3-1/4	9-1/4	CTC-7X2716	135.00
BOWL LIFT RH							
	7J4355		P-UB-10	3-1/4	9-1/4	CTC-7X2716	135.00
	7J4405		P-UB-10	3-1/4	9-1/4	CTC-7X2716	135.00
SPECIAL APPLICATION							
	4J2064	650 only	P-UB-10	2-1/2	6	CTC-7X2679	116.87
	4J9996	650 only	P-UB-10	2-1/2	7-1/4	CTC-7X2661	153.05
MODEL 651							
APRON							
	5J8117		P-UB-10	3-1/4	9-1/4	CTC-7X2708	172.39
BOWL LIFT LH							
	7J4398		P-UB-10	3-1/4	9-1/4	CTC-7X2716	135.00
BOWL LIFT RH							
	7J4397		P-UB-10	3-1/4	9-1/4	CTC-7X2716	135.00
CUSHION HITCH							
	7J4623		P-UB-10	3-1/2	8-1/4	CTC-7X2725	329.13
LOAD							
	3G8757		P-UB-10	3-1/2	8-1/4	CTC-7X2724	171.87
	5J8623		P-UB-10	3-1/2	8-1/4	CTC-7X2728	147.99
STEERING							
	3G9689		P-UB-10	2-3/4	7-1/4	CTC-7X2687	225.35
	4T8563		P-UB-10	3-1/4	7-1/4	CTC-7X2718	168.04
MODEL 651B							
APRON							
	5J8117		P-UB-10	3-1/4	9-1/4	CTC-7X2708	172.39
BOWL LIFT LH							
	7J4398		P-UB-10	3-1/4	9-1/4	CTC-7X2716	135.00
BOWL LIFT RH							
	7J4397		P-UB-10	3-1/4	9-1/4	CTC-7X2716	135.00
CUSHION HITCH							
	7J4623		P-UB-10	3-1/2	8-1/4	CTC-7X2725	329.13
LOAD							
	5J8623		P-UB-10	3-1/2	8-1/4	CTC-7X2728	147.99
	7J4623		P-UB-10	3-1/2	8-1/4	CTC-7X2725	329.13
STEERING							
	3G9689		P-UB-10	2-3/4	7-1/4	CTC-7X2687	225.35
	5J8149		P-UB-10	2-3/4	7-1/4	CTC-7X2687	225.35
MODEL 651C							
APRON							
	5J8117		P-UB-10	3-1/4	9-1/4	CTC-7X2708	172.39
STEERING							
	3G9689		P-UB-10	2-3/4	7-1/4	CTC-7X2687	225.35
	5J8149		P-UB-10	2-3/4	7-1/4	CTC-7X2687	225.35



REPLACEMENT KITS FOR CATERPILLAR® EQUIPMENT

Scrapers							
APPLICATION	CYL #	Misc-Parts, Instructions, etc.	CODE	ROD	BORE	KIT #	List \$
MODEL 651E							
APRON							
	3G8621		P-UB-10	3-1/4	9-1/4	CTC-7X2708	172.39
BOWL LIFT							
	4T5735		P-UB-10	3-1/4	9-1/4	CTC-7X2716	135.00
	4T5736		P-UB-10	3-1/4	9-1/4	CTC-7X2716	135.00
CUSHION HITCH							
	3G8757		P-UB-10	3-1/2	8-1/4	CTC-7X2724	171.87
LOAD							
	3G8757		P-UB-10	3-1/2	8-1/4	CTC-7X2724	171.87
STEERING							
	3G5516		P-UB-10	3-1/4	7-1/4	CTC-7X2718	168.04
	3G9689		P-UB-10	2-3/4	7-1/4	CTC-7X2687	225.35
	4T8563		P-UB-10	3-1/4	7-1/4	CTC-7X2718	168.04
MODEL 651SC							
APRON							
	3G8621		P-UB-10	3-1/4	9-1/4	CTC-7X2708	172.39
BOWL							
	7J4398		P-UB-10	3-1/4	9-1/4	CTC-7X2716	135.00
BOWL LH							
	4T5735		P-UB-10	3-1/4	9-1/4	CTC-7X2716	135.00
LOAD							
	5J8623		P-UB-10	3-1/2	8-1/4	CTC-7X2728	147.99
	7J4623		P-UB-10	3-1/2	8-1/4	CTC-7X2725	329.13
STEERING							
	4T8563		P-UB-10	3-1/4	7-1/4	CTC-7X2718	168.04
MODEL 657							
APRON							
	5J8117		P-UB-10	3-1/4	9-1/4	CTC-7X2708	172.39
BAIL							
	4T5638		P-UB-10	1-3/4	3	CTC-7X2791	74.94
	7J2377		P-U-10	2	3-1/2	CTC-7X2806	102.63
	8J6064		P-U-10	2	3-1/2	CTC-7X2806	102.63
	8J8458		P-UB-10	1-1/2	3-1/2	CTC-7X2752	80.70
BOWL LIFT LH							
	7J4398		P-UB-10	3-1/4	9-1/4	CTC-7X2716	135.00
BOWL LIFT RH							
	7J4397		P-UB-10	3-1/4	9-1/4	CTC-7X2716	135.00
LOAD							
	3G8757		P-UB-10	3-1/2	8-1/4	CTC-7X2724	171.87
LOAD CUSHION							
	5J8623		P-UB-10	3-1/2	8-1/4	CTC-7X2725	329.13
	5J8623		P-UB-10	3-1/2	8-1/4	CTC-7X2728	147.99
	7J4623		P-UB-10	3-1/2	8-1/4	CTC-7X2725	329.13

CATERPILLAR®



REPLACEMENT KITS FOR CATERPILLAR® EQUIPMENT

Scrapers							
APPLICATION	CYL #	Misc-Parts, Instructions, etc.	CODE	ROD	BORE	KIT #	List \$
MODEL 657							
STEERING							
	3G5516		P-UB-10	3-1/4	7-1/4	CTC-7X2718	168.04
	3G9689		P-UB-10	2-3/4	7-1/4	CTC-7X2687	225.35
	4T8563		P-UB-10	3-1/4	7-1/4	CTC-7X2718	168.04
	5J8149		P-UB-10	2-3/4	7-1/4	CTC-7X2687	225.35
MODEL 657B							
APRON							
	5J4354		P-UB-10	3-1/4	9-1/4	CTC-7X2708	172.39
	5J8117		P-UB-10	3-1/4	9-1/4	CTC-7X2708	172.39
BAIL							
	7J2377		P-U-10	2	3-1/2	CTC-7X2806	102.63
	8J6064		P-U-10	2	3-1/2	CTC-7X2806	102.63
	8J8458		P-UB-10	1-1/2	3-1/2	CTC-7X2752	80.70
BOWL LIFT LH							
	7J4398		P-UB-10	3-1/4	9-1/4	CTC-7X2716	135.00
BOWL LIFT RH							
	7J4397		P-UB-10	3-1/4	9-1/4	CTC-7X2716	135.00
LOAD							
	5J8623		P-UB-10	3-1/2	8-1/4	CTC-7X2728	147.99
	7J4623		P-UB-10	3-1/2	8-1/4	CTC-7X2725	329.13
LOAD CUSHION							
	5J8623		P-UB-10	3-1/2	8-1/4	CTC-7X2725	329.13
	7J4623		P-UB-10	3-1/2	8-1/4	CTC-7X2725	329.13
STEERING							
	3G9689		P-UB-10	2-3/4	7-1/4	CTC-7X2687	225.35
	5J8149		P-UB-10	2-3/4	7-1/4	CTC-7X2687	225.35
MODEL 657E							
APRON							
	3G8621		P-UB-10	3-1/4	9-1/4	CTC-7X2708	172.39
BAIL							
	4T5638		P-UB-10	1-3/4	3	CTC-7X2791	74.94
	8J8458		P-UB-10	1-1/2	3-1/2	CTC-7X2752	80.70
BOWL LIFT							
	4T5735		P-UB-10	3-1/4	9-1/4	CTC-7X2716	135.00
	4T5736		P-UB-10	3-1/4	9-1/4	CTC-7X2716	135.00
CUSHION HITCH							
	3G8757		P-UB-10	3-1/2	8-1/4	CTC-7X2724	171.87
EJECTOR							
	9T4886		P-UB-10	4-1/2	6	CTC-8C6958	219.00
	9T4887		I-U-10	6	8-1/4	CTC-1180672	553.86
	9T4887		P-V-10	6	8-1/4	CTC-8T1415	250.25
LOAD							
	3G8757		P-UB-10	3-1/2	8-1/4	CTC-7X2724	171.87
STEERING							
	3G5516		P-UB-10	3-1/4	7-1/4	CTC-7X2718	168.04
	4T8563		P-UB-10	3-1/4	7-1/4	CTC-7X2718	168.04



REPLACEMENT KITS FOR CATERPILLAR® EQUIPMENT

Scrapers							
APPLICATION	CYL #	Misc-Parts, Instructions, etc.	CODE	ROD	BORE	KIT #	List \$
MODEL 657SC							
APRON							
	3G8621		P-UB-10	3-1/4	9-1/4	CTC-7X2708	172.39
	5J8117		P-UB-10	3-1/4	9-1/4	CTC-7X2708	172.39
BAIL							
	7J2377		P-U-10	2	3-1/2	CTC-7X2806	102.63
	8J6062		P-U-10	2	3-1/2	CTC-7X2806	102.63
	8J8457		P-UB-10	1-1/2	3-1/2	CTC-7X2752	80.70
BOWL							
	7J4398		P-UB-10	3-1/4	9-1/4	CTC-7X2716	135.00
BOWL LH							
	4T5735		P-UB-10	3-1/4	9-1/4	CTC-7X2716	135.00
BOWL RH							
	7J4397		P-UB-10	3-1/4	9-1/4	CTC-7X2716	135.00
LOAD							
	5J8623		P-UB-10	3-1/2	8-1/4	CTC-7X2728	147.99
	7J4623		P-UB-10	3-1/2	8-1/4	CTC-7X2725	329.13
STEERING							
	4T8563		P-UB-10	3-1/4	7-1/4	CTC-7X2718	168.04
MODEL 660, 666B							
BOWL LIFT LH							
	7J4356		P-UB-10	3-1/4	9-1/4	CTC-7X2716	135.00
BOWL LIFT RH							
	7J4355		P-UB-10	3-1/4	9-1/4	CTC-7X2716	135.00
SPECIAL APPLICATION							
	4J2064	660 only	P-UB-10	2-1/2	6	CTC-7X2679	116.87
MODEL 660B, 666							
BOWL LIFT LH							
	7J4356		P-UB-10	3-1/4	9-1/4	CTC-7X2716	135.00
	7J4406		P-UB-10	3-1/4	9-1/4	CTC-7X2716	135.00
BOWL LIFT RH							
	7J4355		P-UB-10	3-1/4	9-1/4	CTC-7X2716	135.00
	7J4405		P-UB-10	3-1/4	9-1/4	CTC-7X2716	135.00
SPECIAL APPLICATION							
	4J2064		P-UB-10	2-1/2	6	CTC-7X2679	116.87
	4J9996	666 only	P-UB-10	2-1/2	7-1/4	CTC-7X2661	153.05
MODEL 660SC, 666SC							
BOWL LH							
	7J4356		P-UB-10	3-1/4	9-1/4	CTC-7X2716	135.00
MODEL J621							
FLOOR							
	7J5528		P-UB-10	2-1/2	5	CTC-7X2675	105.11
Skidders							
APPLICATION	CYL #	Misc-Parts, Instructions, etc.	CODE	ROD	BORE	KIT #	List \$
MODEL 508							
BOOM							
	4T0863		P-UB-10	1-3/4	3-1/2	CTC-7X2784	47.66

CATERPILLAR®



REPLACEMENT KITS FOR CATERPILLAR® EQUIPMENT

Skidders							
APPLICATION	CYL #	Misc-Parts, Instructions, etc.	CODE	ROD	BORE	KIT #	List \$
MODEL 508							
GRAPPLE							
	4T0859		P-UB-10	2-1/4	4-1/2	CTC-7X2748	91.01
LIFT LH							
	4T9394		P-UB-10	1-1/2	3	CTC-7X2751	54.17
LIFT RH							
	4T0862		P-UB-10	1-1/2	3	CTC-7X2751	54.17
STEERING LH							
	4T0861		P-UB-10	1-1/2	3-1/4	CTC-7X2741	61.32
STEERING RH							
	4T0860		P-UB-10	1-1/2	3-1/4	CTC-7X2741	61.32
TONG							
	4T0859		P-UB-10	2-1/4	4-1/2	CTC-1326770	127.03
MODEL 515, 525							
LIFT							
	1117951		P-UB-10	2	4	CTC-1113302	100.62
	1397547		P-UB-10	2	4	CTC-1113302	100.62
MODEL 517							
ANGLING							
	1006174		P-UB-10	1-3/4	3-1/2	CTC-7X2784	47.66
LIFT							
	6E0365		P-UB-10	2	4-1/4	CTC-7X2819	88.92
TILT							
	9T9557		P-UB-10	2	4-1/4	CTC-1378662	114.49
MODEL 518							
LIFT							
	7J8925		P-UB-10	2	4	CTC-1328816	78.46
	9T1773		P-UB-10	2-1/2	5	CTC-1315118	150.48
STEERING LH							
	7J3350		P-UB-10	1-3/4	3	CTC-7X2825	42.17
STEERING RH							
	7J3349		P-UB-10	1-3/4	3	CTC-7X2825	42.17
TILT LH							
	9T1777		P-UB-10	2-1/4	4-1/4	CTC-7X2750	96.77
TILT RH							
	9T1772		P-UB-10	2-1/4	4-1/4	CTC-7X2750	96.77
MODEL 518C, 520D, 522C							
LIFT							
	1117951		P-UB-10	2	4	CTC-1113302	100.62
	1397547		P-UB-10	2	4	CTC-1113302	100.62
	7J8925	518C & 522C only	P-UB-10	2	4	CTC-1328816	78.46
STEERING LH							
	7J3350		P-UB-10	1-3/4	3	CTC-7X2825	42.17
STEERING RH							
	7J3349		P-UB-10	1-3/4	3	CTC-7X2825	42.17
MODEL 520C							
LIFT							
	7J8925		P-UB-10	2	4	CTC-7X2789	86.29



REPLACEMENT KITS FOR CATERPILLAR® EQUIPMENT

Skidders							
APPLICATION	CYL #	Misc-Parts, Instructions, etc.	CODE	ROD	BORE	KIT #	List \$
MODEL 520C							
STEERING RH							
	7J3349		P-UB-10	1-3/4	3	CTC-7X2791	74.94
MODEL 525B							
LIFT							
	1600492		P-UB-10	2-1/4	4	CTC-1546526	127.50
MODEL 527							
LIFT							
	1418640		P-UB-10	2-1/4	3-3/4	CTC-1361897	134.65
	1607610		P-UB-10	2-1/2	4-3/4	CTC-1328811	136.56
	6E0366		P-UB-10	2-1/2	4-3/4	CTC-1328811	136.56
MODEL 528							
DOZER LIFT							
	7J9902		P-UB-10	2	4-1/4	CTC-7X2819	88.92
STEERING LH							
	7J9234		P-UB-10	1-1/2	3-1/2	CTC-7X2752	80.70
STEERING RH							
	7J9233		P-UB-10	1-1/2	3-1/2	CTC-7X2752	80.70
MODEL 528B							
DOZER							
	7J9902		P-UB-10	2	4-1/4	CTC-7X2819	88.92
MODEL 530B							
DOZER							
	7J9902		P-UB-10	2	4-1/4	CTC-7X2819	88.92
LIFT							
	7J9902		P-UB-10	2	4-1/4	CTC-7X2819	88.92
MODEL 535B, 545							
LIFT							
	1600492		P-UB-10	2-1/4	4	CTC-1546526	127.50
MODEL FB508							
GRAPPLE							
	4T0860		P-UB-10	1-1/2	3-1/4	CTC-7X2741	61.32
	4T0861		P-UB-10	1-1/2	3-1/4	CTC-7X2741	61.32
	9T5924		P-UB-10	1-1/2	3-1/4	CTC-7X2741	61.32
MODEL FB518							
LIFT							
	9T1773		P-UB-10	2-1/2	5	CTC-7X2658	147.39
STEERING							
	7J3349		P-UB-10	1-3/4	3	CTC-7X2791	74.94
	7J3350		P-UB-10	1-3/4	3	CTC-7X2791	74.94
TILT LH							
	9T1777		P-UB-10	2-1/4	4-1/4	CTC-7X2750	96.77
TILT RH							
	9T1772		P-UB-10	2-1/4	4-1/4	CTC-7X2750	96.77

CATERPILLAR®



REPLACEMENT KITS FOR CATERPILLAR® EQUIPMENT

Soil Compactors							
APPLICATION	CYL #	Misc-Parts, Instructions, etc.	CODE	ROD	BORE	KIT #	List \$
MODEL 815							
LIFT							
	3G0881		P-UB-10	2	4	CTC-7X2789	86.29
	8J6809		P-UB-10	2	4	CTC-7X2755	115.58
	8J8756		P-UB-10	2	4	CTC-7X2789	86.29
LIFT RH							
	4J7859		P-UB-10	2	4	CTC-7X2755	115.58
STEERING							
	4T1574		P-UB-10	2	4	CTC-1328816	78.46
	4T1574		P-UB-10	2	4	CTC-7X2789	86.29
	7J6054		P-UB-10	2	4	CTC-7X2755	115.58
STEERING LH							
	7J9356		P-UB-10	2	4	CTC-7X2755	115.58
STEERING RH							
	7J9355		P-UB-10	2	4	CTC-7X2755	115.58
TILT							
	1U1988		P-UB-10	2	4	CTC-7X2755	115.58
MODEL 815B							
LIFT							
	3G0881		P-UB-10	2	4	CTC-1328816	78.46
	8J6809		P-UB-10	2	4	CTC-7X2755	115.58
STEERING							
	4T1574		P-UB-10	2	4	CTC-1328816	78.46
	6E5024		P-UB-10	2	4	CTC-1113302	100.62
TILT							
	1U1988		P-UB-10	2	4	CTC-7X2755	115.58
MODEL 815F							
LIFT							
	3G0881		P-UB-10	2	4	CTC-1328816	78.46
STEERING							
	4T1574		P-UB-10	2	4	CTC-1328816	78.46
	6E5024		P-UB-10	2	4	CTC-1113302	100.62
MODEL 815S							
TILT							
	1U1988		P-UB-10	2	4	CTC-7X2755	115.58
MODEL 825							
LIFT							
	8J2650		P-UB-10	2	4-1/2	CTC-7X2768	75.01
	9J7934		P-UB-10	2	4-1/2	CTC-7X2768	75.01
STEERING LH							
	9J7087		P-UB-10	2-1/4	5	CTC-7X2729	137.33
STEERING RH							
	9J7086		P-UB-10	2-1/4	5	CTC-7X2729	137.33
TILT							
	9J7951		P-UB-10	2	4-1/2	CTC-7X2768	75.01



REPLACEMENT KITS FOR CATERPILLAR® EQUIPMENT

Soil Compactors							
APPLICATION	CYL #	Misc-Parts, Instructions, etc.	CODE	ROD	BORE	KIT #	List \$
MODEL 825B							
LIFT							
	4J9233		P-V-10	2	4-1/2	CTC-7X2770	82.84
	7J9818		P-UB-10	3	7-1/4	CTC-7X2699	182.12
	8J2650		P-UB-10	2	4-1/2	CTC-7X2768	75.01
	9J7934		P-UB-10	2	4-1/2	CTC-7X2768	75.01
STEERING							
	6J7590		P-UB-10	2-1/4	5	CTC-7X2729	137.33
	7J9718		P-UB-10	2-1/4	5	CTC-7X2729	137.33
	7K9401		P-UB-10	2-1/4	5	CTC-7X2729	137.33
STEERING LH							
	9J7087		P-UB-10	2-1/4	5	CTC-7X2729	137.33
STEERING RH							
	9J7086		P-UB-10	2-1/4	5	CTC-7X2729	137.33
TILT							
	9J7951		P-UB-10	2	4-1/2	CTC-7X2768	75.01
MODEL 825C							
LIFT							
	7J9818		P-UB-10	3	7-1/4	CTC-7X2699	182.12
	8J2650		P-UB-10	2	4-1/2	CTC-7X2768	75.01
	9J7934		P-UB-10	2	4-1/2	CTC-7X2768	75.01
STEERING LH							
	9J7087		P-UB-10	2-1/4	5	CTC-9X6392	135.36
STEERING RH							
	9J7086		P-UB-10	2-1/4	5	CTC-9X6392	135.36
TILT							
	9J7951		P-UB-10	2	4-1/2	CTC-7X2768	75.01
MODEL 825G							
LIFT							
	1199226		P-UB-10	2-1/4	3-3/4	CTC-1361897	134.65
	1447349		P-UB-10	2-1/4	3-3/4	CTC-1361897	134.65
	1493236		P-UB-10	2-1/4	3-3/4	CTC-1361897	134.65
STEERING							
	1175151		P-UB-10	2-1/2	4-1/2	CTC-1113300	115.52
TILT							
	1198863		P-UB-10	2	3-3/4	CTC-7X7938	88.49
MODEL 835							
LIFT							
	4J9233		P-V-10	2	4-1/2	CTC-7X2770	82.84
STEERING							
	7J9984		P-UB-10	2-1/4	5	CTC-7X2729	137.33
Telehandlers							
APPLICATION	CYL #	Misc-Parts, Instructions, etc.	CODE	ROD	BORE	KIT #	List \$
MODEL TH62, TH63, TH82, TH83							
UNSPECIFIED APPLICATION							
	9T4006		P-UB-10	1-1/2	3	CTC-7X2737	91.86

CATERPILLAR®



REPLACEMENT KITS FOR CATERPILLAR® EQUIPMENT

Track-Type Loaders							
APPLICATION	CYL #	Misc-Parts, Instructions, etc.	CODE	ROD	BORE	KIT #	List \$
MODEL 931							
BACKHOE BOOM							
	3G5767		P-UB-10	2-1/4	4-1/2	CTC-7X2748	91.01
	8J5555		P-UB-10	2-1/4	4-1/2	CTC-7X2748	91.01
BACKHOE BUCKET							
	3G5905		P-UB-10	2-1/4	3-1/2	CTC-7X2818	76.31
	8J5642		P-UB-10	2-1/4	3-1/2	CTC-7X2818	76.31
BACKHOE STABILIZER							
	1U2655		P-UB-10	2	4	CTC-1328816	78.46
	1U2656		P-UB-10	2	4	CTC-1328816	78.46
	3G6792		P-UB-10	1-1/2	3-1/2	CTC-7X2752	80.70
	8J6903		P-UB-10	2	4	CTC-1328816	78.46
	8J6904		P-UB-10	2	4	CTC-1328816	78.46
	8J9481		P-UB-10	1-1/2	3-1/2	CTC-7X2752	80.70
BACKHOE STICK							
	3G5771		P-UB-10	2	4	CTC-1328816	78.46
	8J5448		P-UB-10	2	4	CTC-1328816	78.46
LIFT							
	7J5893		P-UB-10	2	4	CTC-1328816	78.46
	7J5894		P-UB-10	2	4	CTC-1328816	78.46
M.P. BUCKET							
	3G7365		P-UB-10	1-1/2	3-1/2	CTC-7X2752	80.70
	8J5391		P-UB-10	1-1/2	3-1/2	CTC-7X2752	80.70
RIPPER							
	7J9920		P-UB-10	2	4	CTC-1328816	78.46
TILT							
	7J5885		P-UB-10	1-3/4	3	CTC-7X2791	74.94
	9J7905		P-UB-10	1-3/4	3	CTC-7X2791	74.94
MODEL 931B							
BACKHOE BOOM/BUCKET							
	3G5767		P-UB-10	2-1/4	4-1/2	CTC-1326770	127.03
	3G5905		P-UB-10	2-1/4	3-1/2	CTC-1358166	145.07
BACKHOE BUCKET							
	8J5642		P-UB-10	2-1/4	3-1/2	CTC-7X2818	76.31
BACKHOE STABILIZER							
	8J6903		P-UB-10	2	4	CTC-7X2789	86.29
	8J6904		P-UB-10	2	4	CTC-7X2789	86.29
	8J9481		P-UB-10	1-1/2	3-1/2	CTC-7X2752	80.70
BACKHOE STICK/BLADE SHIFT							
	3G5771		P-UB-10	2	4	CTC-1328816	78.46
LIFT							
	7J5893		P-UB-10	2	4	CTC-1328816	78.46
	7J5894		P-UB-10	2	4	CTC-1328816	78.46
LIFT LH							
	6E0214		P-UB-10	2	4	CTC-1328816	78.46
	9T6705		P-UB-10	2	4	CTC-1328816	78.46
LIFT RH							
	9T6704		P-UB-10	2	4	CTC-1328816	78.46



REPLACEMENT KITS FOR CATERPILLAR® EQUIPMENT

Track-Type Loaders							
APPLICATION	CYL #	Misc-Parts, Instructions, etc.	CODE	ROD	BORE	KIT #	List \$
MODEL 931B							
M.P. BUCKET							
	3G7365		P-UB-10	1-1/2	3-1/2	CTC-7X2752	80.70
RIPPER							
	7J9920		P-UB-10	2	4	CTC-1328816	78.46
STABILIZER							
	3G6792		P-UB-10	1-1/2	3-1/2	CTC-7X2752	80.70
	8J6903		P-UB-10	2	4	CTC-7X2789	86.29
	8J6904		P-UB-10	2	4	CTC-7X2789	86.29
	8J9481		P-UB-10	1-1/2	3-1/2	CTC-7X2752	80.70
STABILIZER LH							
	1U2656		P-UB-10	2	4	CTC-1328816	78.46
STABILIZER RH							
	1U2655		P-UB-10	2	4	CTC-1328816	78.46
TILT							
	1U3165		P-UB-10	1-3/4	3-1/4	CTC-7X2764	54.01
	4T0963		P-UB-10	1-3/4	3-1/4	CTC-7X2764	54.01
	7J5885		P-UB-10	1-3/4	3	CTC-7X2791	74.94
	9J7905		P-UB-10	1-3/4	3	CTC-7X2791	74.94
MODEL 931C							
BACKHOE BOOM/BUCKET							
	3G5767		P-UB-10	2-1/4	4-1/2	CTC-1326770	127.03
	3G5767		P-UB-10	2-1/4	4-1/2	CTC-7X2748	91.01
	3G5905		P-UB-10	2-1/4	3-1/2	CTC-1358166	145.07
BACKHOE BUCKET							
	8J5642		P-UB-10	2-1/4	3-1/2	CTC-7X2818	76.31
BACKHOE STABILIZER							
	1U2655		P-UB-10	2	4	CTC-7X2789	86.29
	1U2656		P-UB-10	2	4	CTC-7X2789	86.29
	3G6792		P-UB-10	1-1/2	3-1/2	CTC-7X2752	80.70
	8J6903		P-UB-10	2	4	CTC-7X2789	86.29
	8J6904		P-UB-10	2	4	CTC-7X2789	86.29
	8J9481		P-UB-10	1-1/2	3-1/2	CTC-7X2752	80.70
BACKHOE STICK/BLADE SHIFT							
	3G5771		P-UB-10	2	4	CTC-1328816	78.46
BUCKET							
	3G7365		P-UB-10	1-1/2	3-1/2	CTC-7X2752	80.70
LIFT							
	7J5893		P-UB-10	2	4	CTC-1328816	78.46
	7J5894		P-UB-10	2	4	CTC-1328816	78.46
LIFT LH							
	6E0214		P-UB-10	2	4	CTC-1328816	78.46
	9T6705		P-UB-10	2	4	CTC-1328816	78.46
LIFT RH							
	9T6704		P-UB-10	2	4	CTC-1328816	78.46
M.P. BUCKET							
	3G7365		P-UB-10	1-1/2	3-1/2	CTC-7X2752	80.70

CATERPILLAR®



REPLACEMENT KITS FOR CATERPILLAR® EQUIPMENT

Track-Type Loaders							
APPLICATION	CYL #	Misc-Parts, Instructions, etc.	CODE	ROD	BORE	KIT #	List \$
MODEL 931C							
RIPPER							
	7J9920		P-UB-10	2	4	CTC-1328816	78.46
STABILIZER							
	3G6792		P-UB-10	1-1/2	3-1/2	CTC-7X2752	80.70
STABILIZER LH							
	1U2656		P-UB-10	2	4	CTC-1328816	78.46
STABILIZER RH							
	1U2655		P-UB-10	2	4	CTC-1328816	78.46
TILT							
	4T0963		P-UB-10	1-3/4	3-1/4	CTC-7X2764	54.01
MODEL 933							
BUCKET							
	3G7365		P-UB-10	1-1/2	3-1/2	CTC-7X2752	80.70
LIFT LH							
	1052808		P-UB-10	2	4	CTC-1328816	78.46
LIFT RH							
	1052886		P-UB-10	2	4	CTC-1328816	78.46
	6E0212		P-UB-10	2	4	CTC-1328816	78.46
RIPPER							
	7J9920		P-UB-10	2	4	CTC-1328816	78.46
TILT							
	1012493		P-UB-10	1-3/4	3-1/2	CTC-7X2784	47.66
	1368600		P-UB-10	1-3/4	3-1/2	CTC-7X2784	47.66
MODEL 933C							
BUCKET							
	1494362		P-UB-10	2	4	CTC-1328816	78.46
LIFT RH							
	1412421		P-UB-10	2	4	CTC-1328816	78.46
RIPPER							
	7J9920		P-UB-10	2	4	CTC-1328816	78.46
TILT							
	1214264		P-UB-10	1-3/4	3-1/2	CTC-7X2784	47.66
TRACK ADJUSTER							
			TRK ADJ			CTC-FIG4400	40.63
MODEL 933E, 933F, 933G							
TRACK ADJUSTER							
			TRK ADJ			CTC-FIG4400	40.63
MODEL 935B							
BACKHOE / BOOM BUCKET							
	3G5767		P-UB-10	2-1/4	4-1/2	CTC-1326770	127.03
	3G5905		P-UB-10	2-1/4	3-1/2	CTC-1358166	145.07
BACKHOE BUCKET							
	3G7365		P-UB-10	1-1/2	3-1/2	CTC-7X2752	80.70
BACKHOE STICK/BLADE SHIFT							
	3G5771		P-UB-10	2	4	CTC-1328816	78.46



REPLACEMENT KITS FOR CATERPILLAR® EQUIPMENT

Track-Type Loaders							
APPLICATION	CYL #	Misc-Parts, Instructions, etc.	CODE	ROD	BORE	KIT #	List \$
MODEL 935B							
LIFT							
	7J5893		P-UB-10	2	4	CTC-1328816	78.46
	7J5894		P-UB-10	2	4	CTC-1328816	78.46
LIFT LH							
	6E0214		P-UB-10	2	4	CTC-1328816	78.46
	9T6705		P-UB-10	2	4	CTC-1328816	78.46
LIFT RH							
	9T6704		P-UB-10	2	4	CTC-1328816	78.46
RIPPER							
	7J9920		P-UB-10	2	4	CTC-1328816	78.46
STABILIZER							
	3G6792		P-UB-10	1-1/2	3-1/2	CTC-7X2752	80.70
STABILIZER LH							
	1U2656		P-UB-10	2	4	CTC-1328816	78.46
STABILIZER RH							
	1U2655		P-UB-10	2	4	CTC-1328816	78.46
TILT							
	4T0963		P-UB-10	1-3/4	3-1/4	CTC-7X2764	54.01
MODEL 935C							
BACKHOE BOOM/BUCKET							
	3G5767		P-UB-10	2-1/4	4-1/2	CTC-1326770	127.03
	3G5905		P-UB-10	2-1/4	3-1/2	CTC-1358166	145.07
BACKHOE BUCKET							
	3G7365		P-UB-10	1-1/2	3-1/2	CTC-7X2752	80.70
BACKHOE STICK/BLADE SHIFT							
	3G5771		P-UB-10	2	4	CTC-1328816	78.46
LIFT							
	7J5893		P-UB-10	2	4	CTC-1328816	78.46
	7J5894		P-UB-10	2	4	CTC-1328816	78.46
LIFT LH							
	6E0214		P-UB-10	2	4	CTC-1328816	78.46
	9T6705		P-UB-10	2	4	CTC-1328816	78.46
LIFT RH							
	6E0212		P-UB-10	2	4	CTC-1328816	78.46
	9T6704		P-UB-10	2	4	CTC-1328816	78.46
RIPPER							
	7J9920		P-UB-10	2	4	CTC-1328816	78.46
STABILIZER							
	3G6792		P-UB-10	1-1/2	3-1/2	CTC-7X2752	80.70
STABILIZER LH							
	1U2656		P-UB-10	2	4	CTC-1328816	78.46
STABILIZER RH							
	1U2655		P-UB-10	2	4	CTC-1328816	78.46
TILT							
	4T0963		P-UB-10	1-3/4	3-1/4	CTC-7X2764	54.01

CATERPILLAR®



REPLACEMENT KITS FOR CATERPILLAR® EQUIPMENT

Track-Type Loaders							
APPLICATION	CYL #	Misc-Parts, Instructions, etc.	CODE	ROD	BORE	KIT #	List \$
MODEL 939							
BUCKET							
	3G7365		P-UB-10	1-1/2	3-1/2	CTC-7X2752	80.70
LIFT LH							
	1052808		P-UB-10	2	4	CTC-1328816	78.46
LIFT RH							
	1052886		P-UB-10	2	4	CTC-1328816	78.46
	6E0212		P-UB-10	2	4	CTC-1328816	78.46
RIPPER							
	7J9920		P-UB-10	2	4	CTC-1328816	78.46
TILT							
	1012518		P-UB-10	2	4	CTC-1328816	78.46
	1363129		P-UB-10	2	4	CTC-1328816	78.46
MODEL 939C							
BUCKET							
	1494362		P-UB-10	2	4	CTC-1328816	78.46
LIFT							
	1412422		P-UB-10	2-1/2	4-1/2	CTC-1113300	115.52
RIPPER							
	7J9920		P-UB-10	2	4	CTC-1328816	78.46
TILT							
	1414266		P-UB-10	2	4	CTC-1328816	78.46
MODEL 941							
BUCKET							
	7J6789		P-UB-10	2	4	CTC-7X2789	86.29
	8J5663		P-UB-10	2	4	CTC-7X2789	86.29
BUCKET LH							
	6J2806		P-UB-10	2	4	CTC-7X2789	86.29
BUCKET RH							
	6J2805		P-UB-10	2	4	CTC-7X2789	86.29
LIFT							
	8J6868		P-UB-10	2-1/2	4	CTC-7X2659	132.61
LIFT LH							
	6J3082		P-UB-10	2-1/4	4	CTC-7X2802	77.55
	7J9862		P-UB-10	2-1/4	4	CTC-7X2802	77.55
	9J5726		P-UB-10	2-1/4	4	CTC-7X2802	77.55
LIFT RH							
	6J3081		P-UB-10	2-1/4	4	CTC-7X2802	77.55
	7J9861		P-UB-10	2-1/4	4	CTC-7X2802	77.55
	9J5725		P-UB-10	2-1/4	4	CTC-7X2802	77.55
RIPPER							
	6J3308		P-UB-10	2-1/2	5-1/2	CTC-8T1374	79.00
	6J3308		P-UB-10	2-1/2	5-1/2	CTC-9X2050	85.17
SIDE DUMP							
	8J5670		P-UB-10	2	4	CTC-7X2755	115.58
	8J5670		P-UB-10	2	4	CTC-7X7937	126.05
TILT							
			P-UB-10	2-3/8	4	CTC-2418925	47.77



REPLACEMENT KITS FOR CATERPILLAR® EQUIPMENT

Track-Type Loaders							
APPLICATION	CYL #	Misc-Parts, Instructions, etc.	CODE	ROD	BORE	KIT #	List \$
MODEL 941							
TRACK ADJUSTER							
			TRK ADJ			CTC-FIG4400	40.63
MODEL 941B							
BUCKET							
	7J6789		P-UB-10	2	4	CTC-7X2789	86.29
	8J5663		P-UB-10	2	4	CTC-7X2789	86.29
LIFT LH							
	6J3082		P-UB-10	2-1/4	4	CTC-7X2802	77.55
	7J9862		P-UB-10	2-1/4	4	CTC-7X2802	77.55
	9J5726		P-UB-10	2-1/4	4	CTC-7X2802	77.55
LIFT RH							
	6J3081		P-UB-10	2-1/4	4	CTC-7X2802	77.55
	7J9861		P-UB-10	2-1/4	4	CTC-7X2802	77.55
	9J5725		P-UB-10	2-1/4	4	CTC-7X2802	77.55
M.P. BUCKET							
	8J5663		P-UB-10	2	4	CTC-7X2789	86.29
M.P. BUCKET LH							
	6J2806		P-UB-10	2	4	CTC-7X2789	86.29
M.P. BUCKET RH							
	6J2805		P-UB-10	2	4	CTC-7X2789	86.29
RIPPER							
	6J3308		P-UB-10	2-1/2	5-1/2	CTC-8T1374	79.00
	6J3308		P-UB-10	2-1/2	5-1/2	CTC-9X2050	85.17
SIDE DUMP							
	8J5670		P-UB-10	2	4	CTC-7X2755	115.58
	8J5670		P-UB-10	2	4	CTC-7X7937	126.05
TILT							
			P-UB-10	2-3/8	4	CTC-2418925	47.77
TRACK ADJUSTER							
			TRK ADJ			CTC-FIG4400	40.63
MODEL 943							
BUCKET							
	4T9387		P-UB-10	2	4	CTC-1328816	78.46
	9J4892		P-UB-10	2	4	CTC-7X2789	86.29
BUCKET TILT							
	1U4802		P-UB-10	2-1/2	4-3/4	CTC-7X2660	151.93
LIFT							
	4T1963		P-UB-10	2-1/4	4	CTC-7X2795	89.30
	9J0532		P-UB-10	2-1/4	4	CTC-7X2795	89.30
M.P. BUCKET							
	9J4892		P-UB-10	2	4	CTC-7X2789	86.29
RIPPER							
	3G1296		P-UB-10	2	4	CTC-1328816	78.46
TILT							
	1U4802		P-UB-10	2-1/2	4-3/4	CTC-7X2660	151.93
	3G4653		P-UB-10	2-1/2	4-3/4	CTC-7X2660	151.93

CATERPILLAR®



REPLACEMENT KITS FOR CATERPILLAR® EQUIPMENT

Track-Type Loaders							
APPLICATION	CYL #	Misc-Parts, Instructions, etc.	CODE	ROD	BORE	KIT #	List \$
MODEL 943B							
BUCKET							
	4T9387		P-UB-10	2	4	CTC-1328816	78.46
RIPPER							
	3G1296		P-UB-10	2	4	CTC-1328816	78.46
TILT							
	6E0257		P-UB-10	2-1/2	4-3/4	CTC-1328811	136.56
MODEL 951							
LIFT							
	7J9821		P-UB-10	2-1/4	4-1/4	CTC-7X2750	96.77
	7J9822		P-UB-10	2-1/4	4-1/4	CTC-7X2750	96.77
	9J5728		P-UB-10	2-1/4	4-1/4	CTC-7X2750	96.77
LIFT RH							
	9J5727		P-UB-10	2-1/4	4-1/4	CTC-7X2750	96.77
LOG FORK LH							
	8J5677		P-V-10	2	5	CTC-7X2763	114.58
LOG FORK RH							
	8J5676		P-V-10	2	5	CTC-7X2763	114.58
M.P. BUCKET LH							
	6J2806		P-UB-10	2	4	CTC-7X2789	86.29
M.P. BUCKET RH							
	6J2805		P-UB-10	2	4	CTC-7X2789	86.29
RIPPER							
	6J3308		P-UB-10	2-1/2	5-1/2	CTC-8T1374	79.00
TILT							
	4T9387		P-UB-10	2	4	CTC-7X2789	86.29
	5J9815		P-UB-10	2-3/8	4-1/4	CTC-8T1464	45.35
	5J9816		P-UB-10	2-3/8	4-1/4	CTC-8T1464	45.35
	8J5939		P-UB-10	2-3/8	4-1/4	CTC-8T1464	45.35
TILT LH							
	2K3744		P-V-10	2	5	CTC-7X2763	114.58
	3G8083		P-UB-10	2-3/8	4-1/4	CTC-8T1464	45.35
TILT RH							
	2K3743		P-V-10	2	5	CTC-7X2763	114.58
	7J9833		P-UB-10	2-3/8	4-1/4	CTC-8T1464	45.35
TRACK ADJUSTER							
			TRK ADJ			CTC-FIG4400	40.63
MODEL 951B, 951C							
BUCKET							
	7J6789		P-UB-10	2	4	CTC-7X2789	86.29
	8J5663		P-UB-10	2	4	CTC-7X2789	86.29
BUCKET LH							
	6J2806		P-UB-10	2	4	CTC-7X2789	86.29
BUCKET RH							
	6J2805		P-UB-10	2	4	CTC-7X2789	86.29



REPLACEMENT KITS FOR CATERPILLAR® EQUIPMENT

Track-Type Loaders							
APPLICATION	CYL #	Misc-Parts, Instructions, etc.	CODE	ROD	BORE	KIT #	List \$
MODEL 951B, 951C							
LIFT LH							
	6J4014		P-UB-10	2-1/4	4-1/4	CTC-7X2750	96.77
	7J9822		P-UB-10	2-1/4	4-1/4	CTC-7X2750	96.77
	9J5728		P-UB-10	2-1/4	4-1/4	CTC-7X2750	96.77
LIFT RH							
	6J4013		P-UB-10	2-1/4	4-1/4	CTC-7X2750	96.77
	7J9821		P-UB-10	2-1/4	4-1/4	CTC-7X2750	96.77
	9J5727		P-UB-10	2-1/4	4-1/4	CTC-7X2750	96.77
RIPPER							
	6J3308		P-UB-10	2-1/2	5-1/2	CTC-9X2050	85.17
SIDE DUMP							
	8J5670		P-UB-10	2	4	CTC-7X2755	115.58
	8J5670		P-UB-10	2	4	CTC-7X7937	126.05
TILT							
	6J3308		P-UB-10	2-1/2	5-1/2	CTC-8T1374	79.00
	8J5939		P-UB-10	2-3/8	4-1/4	CTC-8T1464	45.35
TILT LH							
	3G8083		P-UB-10	2-3/8	4-1/4	CTC-8T1464	45.35
	5J9815		P-UB-10	2-3/8	4-1/4	CTC-8T1464	45.35
	5J9816		P-UB-10	2-3/8	4-1/4	CTC-8T1464	45.35
	7J9834		P-UB-10	2-3/8	4-1/4	CTC-8T1464	45.35
TILT RH							
	7J9833		P-UB-10	2-3/8	4-1/4	CTC-8T1464	45.35
	8J5939		P-UB-10	2-3/8	4-1/4	CTC-8T1464	45.35
TRACK ADJUSTER							
		951C only	TRK ADJ			CTC-FIG4400	40.63
MODEL 953							
BUCKET							
	4T9387		P-UB-10	2	4	CTC-1328816	78.46
	9J4892		P-UB-10	2	4	CTC-7X2789	86.29
LIFT							
	3G0717		P-UB-10	2-1/2	4-3/4	CTC-7X2660	151.93
	3G0717		P-UB-10	2-1/2	4-3/4	CTC-7X2773	150.91
	4T0263		P-UB-10	2-1/2	4-3/4	CTC-1328811	136.56
	4T0263		P-UB-10	2-1/2	4-3/4	CTC-7X2660	151.93
	4T0263		P-UB-10	2-1/2	4-3/4	CTC-7X2673	150.91
	4T2098		P-UB-10	2-1/2	4-3/4	CTC-1328811	136.56
	4T2098		P-UB-10	2-1/2	4-3/4	CTC-7X2660	151.93
	4T2098		P-UB-10	2-1/2	4-3/4	CTC-7X2673	150.91
	9T3625	Rod Bearing width- 0.98"	P-UB-10	2-1/2	4-3/4	CTC-1361131	121.12
RIPPER							
	3G1296		P-UB-10	2	4	CTC-1328816	78.46
SIDE DUMP							
	9T0107		P-UB-10	2	4	CTC-7X2789	86.29
TILT							
	1U0418		P-UB-10	3	5-1/2	CTC-1281673	193.33
	4T1063		P-UB-10	2	4-1/4	CTC-7X2766	37.33

CATERPILLAR®



REPLACEMENT KITS FOR CATERPILLAR® EQUIPMENT

Track-Type Loaders							
APPLICATION	CYL #	Misc-Parts, Instructions, etc.	CODE	ROD	BORE	KIT #	List \$
MODEL 953B							
BUCKET							
	4T9387		P-UB-10	2	4	CTC-1328816	78.46
LIFT							
	9T3625	Rod Bearing width- 0.98"	P-UB-10	2-1/2	4-3/4	CTC-1361131	121.12
RIPPER							
	3G1296		P-UB-10	2	4	CTC-1328816	78.46
TILT							
	1U0418		P-UB-10	3	5-1/2	CTC-1281673	193.33
MODEL 953C							
BUCKET							
	4T9387		P-UB-10	2	4	CTC-1328816	78.46
LIFT							
	9T3625	Rod Bearing width- 0.98"	P-UB-10	2-1/2	4-3/4	CTC-1361131	121.12
RIPPER							
	3G1296		P-UB-10	2	4	CTC-1328816	78.46
TILT							
	1U0418		P-UB-10	3	5-1/2	CTC-1281673	193.33
MODEL 955							
LIFT							
	5J6342		P-UB-10	2-1/2	5-1/2	CTC-9X2050	85.17
	7J1730		P-UB-10	2-1/2	5-1/2	CTC-9X2047	91.52
	7J9640		P-UB-10	2-1/2	5-1/2	CTC-9X2047	91.52
LIFT LH							
	9J2399		P-UB-10	2-1/2	5-1/2	CTC-9X2047	91.52
	9J2399		P-UB-10	2-1/2	5-1/2	CTC-9X2050	85.17
LIFT RH							
	9J2401		P-UB-10	2-1/2	5-1/2	CTC-9X2047	91.52
	9J2401		P-UB-10	2-1/2	5-1/2	CTC-9X2050	85.17
LOG FORK LH							
	8J5677		P-V-10	2	5	CTC-7X2763	114.58
LOG FORK RH							
	8J5676		P-V-10	2	5	CTC-7X2763	114.58
RIPPER							
	5J8190		P-UB-10	2-1/2	5-1/2	CTC-8T1374	79.00
TILT LH							
	2K3744		P-V-10	2	5	CTC-7X2763	114.58
	3G8081		P-UB-10	2-1/2	5	CTC-7X2658	147.39
TILT RH							
	2K3743		P-V-10	2	5	CTC-7X2763	114.58
	7J9637		P-UB-10	2-1/2	5	CTC-1304012	161.86
MODEL 955C							
BUCKET							
	7Y5100		P-UB-10	85 mm	130 mm	CTC-7Y5145	226.08
TRACK ADJUSTER							
			TRK ADJ			CTC-FIG4400	40.63
UNSPECIFIED APPLICATION							
	8J5676		P-V-10	2	5	CTC-7X2763	114.58



REPLACEMENT KITS FOR CATERPILLAR® EQUIPMENT

Track-Type Loaders							
APPLICATION	CYL #	Misc-Parts, Instructions, etc.	CODE	ROD	BORE	KIT #	List \$
MODEL 955E							
BUCKET							
	7Y5100		P-UB-10	85 mm	130 mm	CTC-7Y5145	226.08
LOG FORK LH							
	8J5677		P-V-10	2	5	CTC-7X2763	114.58
LOG FORK RH							
	8J5676		P-V-10	2	5	CTC-7X2763	114.58
TRACK ADJUSTER							
			TRK ADJ			CTC-FIG4400	40.63
MODEL 955F							
TILT LH							
	2K3744		P-V-10	2	5	CTC-7X2763	114.58
TILT RH							
	2K3743		P-V-10	2	5	CTC-7X2763	114.58
TRACK ADJUSTER							
			TRK ADJ			CTC-FIG4400	40.63
MODEL 955H							
LOG FORK LH							
	8J5677		P-V-10	2	5	CTC-7X2763	114.58
LOG FORK RH							
	8J5676		P-V-10	2	5	CTC-7X2763	114.58
RIPPER							
	6J3308		P-UB-10	2-1/2	5-1/2	CTC-8T1374	79.00
	6J3308		P-UB-10	2-1/2	5-1/2	CTC-9X2050	85.17
TILT LH							
	2K3744		P-V-10	2	5	CTC-7X2763	114.58
TILT RH							
	2K3743		P-V-10	2	5	CTC-7X2763	114.58
TRACK ADJUSTER							
			TRK ADJ			CTC-FIG4400	40.63
MODEL 955K							
BUCKET LH							
	8J5704		P-V-10	2	4-1/2	CTC-1328783	63.16
BUCKET RH							
	8J5703		P-V-10	2	4-1/2	CTC-1328783	63.16
CLAMP							
	8J8498		P-V-10	2	4-1/2	CTC-1328783	63.16
LIFT							
	5J6342		P-UB-10	2-1/2	5-1/2	CTC-8T1374	79.00
	7J1730		P-UB-10	2-1/2	5-1/2	CTC-9X2047	91.52
	7J9640		P-UB-10	2-1/2	5-1/2	CTC-9X2047	91.52
LIFT LH							
	9J2399		P-UB-10	2-1/2	5-1/2	CTC-9X2050	85.17
LIFT RH							
	9J2401		P-UB-10	2-1/2	5-1/2	CTC-9X2050	85.17
RIPPER							
	5J8190		P-UB-10	2-1/2	5-1/2	CTC-8T1374	79.00
	5J8190		P-UB-10	2-1/2	5-1/2	CTC-9X2050	85.17

CATERPILLAR®



REPLACEMENT KITS FOR CATERPILLAR® EQUIPMENT

Track-Type Loaders							
APPLICATION	CYL #	Misc-Parts, Instructions, etc.	CODE	ROD	BORE	KIT #	List \$
MODEL 955K							
TILT							
	3G8081		P-UB-10	2-1/2	5	CTC-7X2658	147.39
TILT LH							
	5J6214		P-UB-10	2-1/2	5	CTC-1304012	161.86
	7J9638		P-UB-10	2-1/2	5	CTC-7X2658	147.39
TILT RH							
	5J6213		P-UB-10	2-1/2	5	CTC-1304012	161.86
	7J9637		P-UB-10	2-1/2	5	CTC-7X2658	147.39
TRACK ADJUSTER							
			TRK ADJ			CTC-FIG3400	50.60
			TRK ADJ			CTC-FIG4400	40.63
MODEL 955L							
BUCKET LH							
	8J5704		P-V-10	2	4-1/2	CTC-1328783	63.16
BUCKET RH							
	8J5703		P-V-10	2	4-1/2	CTC-1328783	63.16
CLAMP							
	8J8498		P-V-10	2	4-1/2	CTC-1328783	63.16
LIFT							
	5J6342		P-UB-10	2-1/2	5-1/2	CTC-8T1374	79.00
	7J1730		P-UB-10	2-1/2	5-1/2	CTC-9X2047	91.52
	7J9640		P-UB-10	2-1/2	5-1/2	CTC-9X2047	91.52
LIFT LH							
	9J2399		P-UB-10	2-1/2	5-1/2	CTC-9X2050	85.17
LIFT RH							
	9J2401		P-UB-10	2-1/2	5-1/2	CTC-9X2050	85.17
RIPPER							
	5J8190		P-UB-10	2-1/2	5-1/2	CTC-9X2050	85.17
TILT							
	3G8081		P-UB-10	2-1/2	5	CTC-7X2658	147.39
TILT LH							
	5J6214		P-UB-10	2-1/2	5	CTC-1304012	161.86
	7J9638		P-UB-10	2-1/2	5	CTC-7X2658	147.39
TILT RH							
	5J6213		P-UB-10	2-1/2	5	CTC-1304012	161.86
	7J9637		P-UB-10	2-1/2	5	CTC-7X2658	147.39
TRACK ADJUSTER							
			TRK ADJ			CTC-FIG3400	50.60
MODEL 963							
CLAMP							
	8J8498		P-V-10	2	4-1/2	CTC-1328783	63.16
DOZER TILT							
	4T1625		P-UB-10	2-1/4	4-3/4	CTC-7X2815	81.81
LIFT							
	4T0263		P-UB-10	2-1/2	4-3/4	CTC-1328811	136.56
	9J8002		P-UB-10	2-3/4	5-1/2	CTC-1327131	169.48



REPLACEMENT KITS FOR CATERPILLAR® EQUIPMENT

Track-Type Loaders							
APPLICATION	CYL #	Misc-Parts, Instructions, etc.	CODE	ROD	BORE	KIT #	List \$
MODEL 963							
RIPPER							
	9J9881		P-UB-10	2-1/4	4-1/2	CTC-1326770	127.03
RIPPER LIFT							
	8J1779		P-UB-10	2-1/2	7-1/4	CTC-7X2661	153.05
RIPPER RH							
	1U3497		P-UB-10	2-1/4	4-1/2	CTC-1326770	127.03
TILT							
	3G3874		P-UB-10	3-3/4	6-1/2	CTC-7X2731	219.13
	4T1625		P-UB-10	2-1/4	4-3/4	CTC-7X2815	81.81
	9T1403		P-UB-10	3	6	CTC-7X2698	157.60
TRACK ADJUSTER							
			TRK ADJ			CTC-FIG3400	50.60
			TRK ADJ			CTC-FIG3401	47.23
MODEL 963B, 963C							
CLAMP							
	8J8498		P-V-10	2	4-1/2	CTC-1328783	63.16
LIFT							
			P-UB-10	2-3/4	5-1/2	CTC-2601518	104.07
RIPPER							
	1228420		P-UB-10	2-1/4	4-1/2	CTC-1326770	127.03
RIPPER RH							
	1228421		P-UB-10	2-1/4	4-1/2	CTC-1326770	127.03
TILT							
	3G3874		P-UB-10	3-3/4	6-1/2	CTC-7X2731	219.13
MODEL 973							
BUCKET							
	9J1822		P-UB-10	2	5	CTC-7X2788	94.88
LIFT							
	3G0218		P-UB-10	3-1/4	6-1/2	CTC-7X2711	177.37
	4T2098		P-UB-10	2-1/2	4-3/4	CTC-1328811	136.56
RIPPER							
	3G1194		P-UB-10	2-1/2	5	CTC-1315106	142.87
	4T7606		P-UB-10	2-1/2	5	CTC-7X2658	147.39
TILT							
	3G5949		P-UB-10	3-1/4	5-1/2	CTC-7X2712	78.37
	3G6571		P-UB-10	2-1/2	4-3/4	CTC-7X2773	150.91
TRACK ADJUSTER							
			TRK ADJ			CTC-FIG3400	50.60
			TRK ADJ			CTC-FIG3401	47.23
MODEL 973C							
BUCKET							
	9J1822		P-UB-10	2	5	CTC-7X2788	94.88
RIPPER							
	4T7606		P-UB-10	2-1/2	5	CTC-7X2658	147.39
TILT							
	3G5949		P-UB-10	3-1/4	5-1/2	CTC-7X2712	78.37

CATERPILLAR®



REPLACEMENT KITS FOR CATERPILLAR® EQUIPMENT

Track-Type Loaders							
APPLICATION	CYL #	Misc-Parts, Instructions, etc.	CODE	ROD	BORE	KIT #	List \$
MODEL 977							
LIFT LH	7J9376		P-UB-10	2-3/4	6-1/2	CTC-9X2473	113.83
LIFT RH	7J9375		P-UB-10	2-3/4	6-1/2	CTC-9X2473	113.83
LIFT STEEL	3G8118		P-V-10	2-3/4	6-1/2	CTC-8T1554	116.53
LOG FORK	1K8206		P-V-10	2	5	CTC-7X2763	114.58
	8J5755		P-UB-10	2-1/4	5	CTC-7X2729	137.33
LOG FORK LH	8J5677		P-V-10	2	5	CTC-7X2763	114.58
LOG FORK RH	8J5676		P-V-10	2	5	CTC-7X2763	114.58
M.P. BUCKET	9J1822		P-UB-10	2	5	CTC-7X2788	94.88
	9J1822		P-V-10	2	5	CTC-7X2797	59.98
RIPPER	5J7686		P-UB-10	2-1/2	6-1/2	CTC-7X2666	143.68
TILT LH	9J0670		P-V-10	2-3/4	6	CTC-8T1553	95.56
	9J0673		P-UB-10	2-3/4	6	CTC-7X2803	144.98
TILT RH	9J0671		P-V-10	2-3/4	6	CTC-8T1553	95.56
	9J0672		P-UB-10	2-3/4	6	CTC-7X2803	144.98
TILT STEEL	3G8119		P-V-10	2-3/4	6-1/2	CTC-8T1554	116.53
MODEL 977D							
TRACK ADJUSTER			TRK ADJ			CTC-FIG3400	50.60
MODEL 977H							
M.P. BUCKET	8J5733		P-V-10	2	5	CTC-7X2763	114.58
RIPPER	2K3663		P-UB-10	2-1/2	7-1/4	CTC-7X2661	153.05
RIPPER LIFT	8J1779		P-UB-10	2-1/2	7-1/4	CTC-7X2661	153.05
TRACK ADJUSTER			TRK ADJ			CTC-FIG3400	50.60
MODEL 977K							
BUCKET	8J5761		P-UB-10	2-1/2	5-1/2	CTC-9X2050	85.17
	9J1822		P-UB-10	2	5	CTC-7X2788	94.88
LIFT LH	3G8118		P-V-10	2-3/4	6-1/2	CTC-8T1554	116.53
	7J9376		P-UB-10	2-3/4	6-1/2	CTC-7X2686	102.12



REPLACEMENT KITS FOR CATERPILLAR® EQUIPMENT

Track-Type Loaders							
APPLICATION	CYL #	Misc-Parts, Instructions, etc.	CODE	ROD	BORE	KIT #	List \$
MODEL 977K							
LIFT RH							
	3G8119		P-V-10	2-3/4	6-1/2	CTC-8T1554	116.53
	7J9375		P-UB-10	2-3/4	6-1/2	CTC-7X2686	102.12
LOG FORK							
	8J5755		P-UB-10	2-1/4	5	CTC-7X2729	137.33
RIPPER							
	5J7686		P-UB-10	2-1/2	6-1/2	CTC-7X2666	143.68
SIDE DUMP							
	5J9893		P-UB-10	2-1/2	5	CTC-1315106	142.87
TILT							
	3G8119		P-V-10	2-3/4	6-1/2	CTC-8T1554	116.53
TILT BUCKET LH							
	8J5740		P-UB-10	2	5	CTC-7X2788	94.88
TILT BUCKET RH							
	8J5739		P-UB-10	2	5	CTC-7X2788	94.88
TILT LH							
	9J0670		P-V-10	2-3/4	6	CTC-8T1553	95.56
	9J0673		P-UB-10	2-3/4	6	CTC-7X2803	144.98
TILT RH							
	9J0671		P-V-10	2-3/4	6	CTC-8T1553	95.56
	9J0672		P-UB-10	2-3/4	6	CTC-7X2803	144.98
TRACK ADJUSTER							
			TRK ADJ			CTC-FIG3400	50.60
MODEL 977L							
BUCKET							
	8J5761		P-UB-10	2-1/2	5-1/2	CTC-9X2050	85.17
	9J1822		P-UB-10	2	5	CTC-7X2788	94.88
LIFT LH							
	3G8118		P-V-10	2-3/4	6-1/2	CTC-8T1554	116.53
	7J9376		P-UB-10	2-3/4	6-1/2	CTC-7X2686	102.12
LIFT RH							
	3G8119		P-V-10	2-3/4	6-1/2	CTC-8T1554	116.53
	7J9375		P-UB-10	2-3/4	6-1/2	CTC-7X2686	102.12
LOG FORK							
	8J5755		P-UB-10	2-1/4	5	CTC-7X2729	137.33
RIPPER							
	5J7686		P-UB-10	2-1/2	6-1/2	CTC-7X2666	143.68
SIDE DUMP							
	5J9893		P-UB-10	2-1/2	5	CTC-1315106	142.87
TILT BUCKET LH							
	8J5740		P-UB-10	2	5	CTC-7X2788	94.88
TILT BUCKET RH							
	8J5739		P-UB-10	2	5	CTC-7X2788	94.88
TILT LH							
	9J0670		P-V-10	2-3/4	6	CTC-8T1553	95.56
	9J0673		P-UB-10	2-3/4	6	CTC-7X2803	144.98

CATERPILLAR®



REPLACEMENT KITS FOR CATERPILLAR® EQUIPMENT

Track-Type Loaders							
APPLICATION	CYL #	Misc-Parts, Instructions, etc.	CODE	ROD	BORE	KIT #	List \$
MODEL 977L							
TILT RH							
	9J0671		P-V-10	2-3/4	6	CTC-8T1553	95.56
	9J0672		P-UB-10	2-3/4	6	CTC-7X2803	144.98
TRACK ADJUSTER							
			TRK ADJ			CTC-FIG3400	50.60
MODEL 983							
BUCKET CLAMP							
	8J5772		P-UB-10	2-1/2	6	CTC-7X2669	197.74
BUCKET DEMOLITION							
	8J5772		P-UB-10	2-1/2	6	CTC-7X2669	197.74
TRACK ADJUSTER							
			TRK ADJ			CTC-FIG2400	64.99
MODEL 983B							
TRACK ADJUSTER							
			TRK ADJ			CTC-FIG2400	64.99
Track-Type Tractors							
APPLICATION	CYL #	Misc-Parts, Instructions, etc.	CODE	ROD	BORE	KIT #	List \$
MODEL D2							
UNSPECIFIED APPLICATION							
	4H6711		P-V-10	1-1/4	4	CTC-8T1480	69.97
MODEL D3							
ANGLING							
	8J0096		P-UB-10	1-1/2	3-1/2	CTC-7X2752	80.70
	9J8698		P-UB-10	1-1/2	3-1/2	CTC-7X2752	80.70
	9J8761		P-UB-10	1-1/2	3-1/2	CTC-7X2752	80.70
BACKHOE BOOM							
	8J5555		P-UB-10	2-1/4	4-1/2	CTC-7X2748	91.01
BACKHOE BUCKET							
	3G5905		P-UB-10	2-1/4	3-1/2	CTC-7X2818	76.31
	8J5642		P-UB-10	2-1/4	3-1/2	CTC-7X2818	76.31
BACKHOE STABILIZER							
	1U2655		P-UB-10	2	4	CTC-7X2789	86.29
	1U2656		P-UB-10	2	4	CTC-7X2789	86.29
	8J9481		P-UB-10	1-1/2	3-1/2	CTC-7X2752	80.70
BACKHOE STICK							
	8J5448		P-UB-10	2	4	CTC-7X2789	86.29
LIFT							
	7J9223		P-UB-10	1-1/2	3-1/2	CTC-7X2752	80.70
	7J9224		P-UB-10	1-1/2	3-1/2	CTC-7X2752	80.70
	8J6894		P-UB-10	1-1/2	3-1/2	CTC-7X2752	80.70
RIPPER							
	7J9920		P-UB-10	2	4	CTC-1328816	78.46
RIPPER PIN PULLER							
	4H6711		P-V-10	1-1/4	4	CTC-8T1480	69.97



REPLACEMENT KITS FOR CATERPILLAR® EQUIPMENT

Track-Type Tractors							
APPLICATION	CYL #	Misc-Parts, Instructions, etc.	CODE	ROD	BORE	KIT #	List \$
MODEL D3							
TILT							
	8J0095		P-UB-10	1-1/2	3-1/2	CTC-7X2752	80.70
	8J6893		P-UB-10	2	4	CTC-7X2789	86.29
	9J4042		P-UB-10	1-1/2	3-1/2	CTC-7X2752	80.70
	9J8674		P-UB-10	1-1/2	3-1/2	CTC-7X2752	80.70
TRACK ADJUSTER							
			TRK ADJ			CTC-FIG4405	18.92
MODEL D3 LGP							
LIFT							
	8J6894		P-UB-10	1-1/2	3-1/2	CTC-7X2752	80.70
MODEL D3B							
ANGLING							
	9J8698		P-UB-10	1-1/2	3-1/2	CTC-1327058	87.86
	9J8761		P-UB-10	1-1/2	3-1/2	CTC-7X2752	80.70
BACKHOE BOOM/BUCKET							
	3G5767		P-UB-10	2-1/4	4-1/2	CTC-1326770	127.03
	3G5905		P-UB-10	2-1/4	3-1/2	CTC-1358166	145.07
BACKHOE STABILIZER							
	8J6903		P-UB-10	2	4	CTC-7X2789	86.29
	8J6904		P-UB-10	2	4	CTC-7X2789	86.29
	8J9481		P-UB-10	1-1/2	3-1/2	CTC-7X2752	80.70
BACKHOE STICK/BLADE SHIFT							
	3G5771		P-UB-10	2	4	CTC-1328816	78.46
LIFT							
	7J9223		P-UB-10	1-1/2	3-1/2	CTC-1327058	87.86
	8J6894		P-UB-10	1-1/2	3-1/2	CTC-7X2752	80.70
	9T4000		P-UB-10	1-1/2	4	CTC-7X2738	73.99
	9T6652		P-UB-10	1-1/2	3-1/2	CTC-1327058	87.86
RIPPER							
	7J9920		P-UB-10	2	4	CTC-1328816	78.46
STABILIZER							
	3G6792		P-UB-10	1-1/2	3-1/2	CTC-7X2752	80.70
STABILIZER LH							
	1U2656		P-UB-10	2	4	CTC-1328816	78.46
STABILIZER RH							
	1U2655		P-UB-10	2	4	CTC-1328816	78.46
TILT							
	8J0095		P-UB-10	1-1/2	3-1/2	CTC-7X2752	80.70
	8J6893		P-UB-10	2	4	CTC-1328816	78.46
	9J4042		P-UB-10	1-1/2	3-1/2	CTC-7X2752	80.70
	9J8674		P-UB-10	1-1/2	3-1/2	CTC-1327058	87.86
TRACK ADJUSTER							
			TRK ADJ			CTC-FIG4405	18.92

CATERPILLAR®



REPLACEMENT KITS FOR CATERPILLAR® EQUIPMENT

Track-Type Tractors							
APPLICATION	CYL #	Misc-Parts, Instructions, etc.	CODE	ROD	BORE	KIT #	List \$
MODEL D3C							
ANGLING							
	1026237		P-UB-10	1-1/2	3-1/2	CTC-1327058	87.86
	1363155		P-UB-10	1-1/2	3-1/2	CTC-1327058	87.86
	1363156		P-UB-10	1-1/2	3-1/2	CTC-1327058	87.86
	1386859		P-UB-10	1-1/2	3	CTC-7X2751	54.17
	1390548		P-UB-10	1-1/2	3	CTC-7X2751	54.17
	9J8698		P-UB-10	1-1/2	3-1/2	CTC-1327058	87.86
BACKHOE BOOM							
	3G5767		P-UB-10	2-1/4	4-1/2	CTC-7X2748	91.01
BACKHOE BUCKET							
	3G5905		P-UB-10	2-1/4	3-1/2	CTC-7X2818	76.31
BACKHOE STABILIZER							
	3G6792		P-UB-10	1-1/2	3-1/2	CTC-7X2752	80.70
BACKHOE STICK							
	3G5771		P-UB-10	2	4	CTC-7X2789	86.29
LIFT							
	1412915		P-UB-10	1-1/2	3-1/2	CTC-1327058	87.86
	7J9223		P-UB-10	1-1/2	3-1/2	CTC-1327058	87.86
	8J6894		P-UB-10	1-1/2	3-1/2	CTC-7X2752	80.70
LIFT RH							
	6E0212		P-UB-10	2	4	CTC-1328816	78.46
RIPPER							
	7J9920		P-UB-10	2	4	CTC-1328816	78.46
TILT							
	1437219		P-UB-10	1-1/2	3-1/2	CTC-1327058	87.86
	8J0095		P-UB-10	1-1/2	3-1/2	CTC-7X2752	80.70
	8J6893		P-UB-10	2	4	CTC-1328816	78.46
	9J4042		P-UB-10	1-1/2	3-1/2	CTC-7X2752	80.70
	9J8674		P-UB-10	1-1/2	3-1/2	CTC-1327058	87.86
TRACK ADJUSTER							
			TRK ADJ			CTC-FIG4405	18.92
MODEL D4B							
ANGLING							
	9J8698		P-UB-10	1-1/2	3-1/2	CTC-7X2752	80.70
BACKHOE BOOM/BUCKET							
	3G5767		P-UB-10	2-1/4	4-1/2	CTC-1326770	127.03
	3G5905		P-UB-10	2-1/4	3-1/2	CTC-1358166	145.07
BACKHOE STICK/BLADE SHIFT							
	3G5771		P-UB-10	2	4	CTC-1328816	78.46
LIFT							
	7J9223		P-UB-10	1-1/2	3-1/2	CTC-1327058	87.86
	9T6652		P-UB-10	1-1/2	3-1/2	CTC-1327058	87.86
RIPPER							
	7J9920		P-UB-10	2	4	CTC-1328816	78.46
STABILIZER							
	3G6792		P-UB-10	1-1/2	3-1/2	CTC-7X2752	80.70



REPLACEMENT KITS FOR CATERPILLAR® EQUIPMENT

Track-Type Tractors							
APPLICATION	CYL #	Misc-Parts, Instructions, etc.	CODE	ROD	BORE	KIT #	List \$
MODEL D4B							
STABILIZER LH							
	1U2656		P-UB-10	2	4	CTC-1328816	78.46
STABILIZER RH							
	1U2655		P-UB-10	2	4	CTC-1328816	78.46
TILT							
	9J8674		P-UB-10	1-1/2	3-1/2	CTC-1327058	87.86
TRACK ADJUSTER							
			TRK ADJ			CTC-FIG4405	18.92
MODEL D4C							
ANGLING							
	1363156		P-UB-10	1-1/2	3-1/2	CTC-1327058	87.86
	1390548		P-UB-10	1-1/2	3	CTC-7X2751	54.17
	9J8698		P-UB-10	1-1/2	3-1/2	CTC-1327058	87.86
LIFT							
	1412915		P-UB-10	1-1/2	3-1/2	CTC-1327058	87.86
	7J9223		P-UB-10	1-1/2	3-1/2	CTC-1327058	87.86
	8J6894		P-UB-10	1-1/2	3-1/2	CTC-7X2752	80.70
RIPPER							
	7J9920		P-UB-10	2	4	CTC-1328816	78.46
TILT							
	1437219		P-UB-10	1-1/2	3-1/2	CTC-1327058	87.86
	9J8674		P-UB-10	1-1/2	3-1/2	CTC-1327058	87.86
TRACK ADJUSTER							
			TRK ADJ			CTC-FIG4400	40.63
			TRK ADJ			CTC-FIG4405	18.92
MODEL D4D							
DOZER							
	4J4890		P-U-10	2	3-1/2	CTC-7X2806	102.63
	4J4891		P-U-10	2	3-1/2	CTC-7X2806	102.63
	4T4575		P-UB-10	2	3-1/2	CTC-7X2769	95.48
	5J1603		P-V-10	2	4-3/4	CTC-7X2677	99.00
DOZER LIFT							
	8J6894		P-UB-10	1-1/2	3-1/2	CTC-7X2752	80.70
RIPPER							
	6J3308		P-UB-10	2-1/2	5-1/2	CTC-8T1374	79.00
	6J3308		P-UB-10	2-1/2	5-1/2	CTC-9X2050	85.17
RIPPER PIN PULLER							
	4H6711		P-V-10	1-1/4	4	CTC-8T1480	69.97
TILT							
	5J1603		P-V-10	2	4-3/4	CTC-7X2677	99.00
TRACK ADJUSTER							
			TRK ADJ			CTC-FIG4400	40.63
MODEL D4E							
DOZER							
	4T4574		P-UB-10	2	3-1/2	CTC-7X2769	95.48
	4T4575		P-UB-10	2	3-1/2	CTC-7X2769	95.48

CATERPILLAR®



REPLACEMENT KITS FOR CATERPILLAR® EQUIPMENT

Track-Type Tractors							
APPLICATION	CYL #	Misc-Parts, Instructions, etc.	CODE	ROD	BORE	KIT #	List \$
MODEL D4E							
DOZER TILT							
	5J1603		P-V-10	2	4-3/4	CTC-7X2677	99.00
LIFT							
	3G0892		P-UB-10	1-3/4	3-1/2	CTC-7X2762	84.64
	3G0892		P-UB-10	1-3/4	3-1/2	CTC-7X2784	47.66
	7J8302		P-UB-10	2-1/2	4	CTC-7X2659	132.61
	7J9223		P-UB-10	1-1/2	3-1/2	CTC-7X2752	80.70
	8J6894		P-UB-10	1-1/2	3-1/2	CTC-7X2752	80.70
RIPPER							
	3G5189		P-UB-10	2-1/2	5	CTC-7X2658	147.39
	6J3308		P-UB-10	2-1/2	5-1/2	CTC-8T1374	79.00
	6J3308		P-UB-10	2-1/2	5-1/2	CTC-9X2050	85.17
RIPPER PIN PULLER							
	4H6711		P-V-10	1-1/4	4	CTC-8T1480	69.97
STEERING							
	3G0892		P-UB-10	1-3/4	3-1/2	CTC-7X2762	84.64
	3G0892		P-UB-10	1-3/4	3-1/2	CTC-7X2784	47.66
	4T1574		P-UB-10	2	4	CTC-7X2789	86.29
	6E4892		P-UB-10	1-3/4	3-1/2	CTC-7X2784	47.66
	7J9685		P-UB-10	1-1/2	3-1/2	CTC-7X2812	88.00
TILT							
	5J1603		P-V-10	2	4-3/4	CTC-7X2677	99.00
TRACK ADJUSTER							
			TRK ADJ			CTC-FIG4400	40.63
MODEL D4H							
ANGLING							
	1006174		P-UB-10	1-3/4	3-1/2	CTC-7X2784	47.66
	4T1683		P-UB-10	1-3/4	3-1/2	CTC-7X2784	47.66
	9T9247		P-UB-10	1-3/4	3-1/2	CTC-7X2784	47.66
DOZER LIFT							
	3G9226		P-UB-10	2	4-1/4	CTC-7X2819	88.92
LIFT							
	3G9226		P-UB-10	2	4-1/4	CTC-7X2819	88.92
	4T4783		P-UB-10	2-1/4	3-3/4	CTC-7X2798	64.20
	8J6894		P-UB-10	1-1/2	3-1/2	CTC-7X2752	80.70
RIPPER							
	3G9892		P-UB-10	2	4	CTC-1328816	78.46
TILT							
	1U2568		P-UB-10	2	4-1/4	CTC-7X2819	88.92
	4T1063		P-UB-10	2	4-1/4	CTC-1378662	114.49
	8J6893		P-UB-10	2	4	CTC-7X2789	86.29
	9T8760		P-UB-10	2	4-1/4	CTC-1378662	114.49
	9T8760		P-UB-10	2	4-1/4	CTC-7X2766	37.33
	9T9557		P-UB-10	2	4-1/4	CTC-1378662	114.49
MODEL D4L							
DOZER LIFT							
	3G9226		P-UB-10	2	4-1/4	CTC-7X2819	88.92



REPLACEMENT KITS FOR CATERPILLAR® EQUIPMENT

Track-Type Tractors							
APPLICATION	CYL #	Misc-Parts, Instructions, etc.	CODE	ROD	BORE	KIT #	List \$
MODEL D4TSKH							
ANGLING							
	1006174		P-UB-10	1-3/4	3-1/2	CTC-7X2784	47.66
	9T9247		P-UB-10	1-3/4	3-1/2	CTC-7X2784	47.66
LIFT							
	6E0365		P-UB-10	2	4-1/4	CTC-7X2819	88.92
	6E0366		P-UB-10	2-1/2	4-3/4	CTC-1328811	136.56
TILT							
	9T9557		P-UB-10	2	4-1/4	CTC-1378662	114.49
MODEL D5							
DOZER							
	5J8174		P-UB-10	2-1/2	4-1/4	CTC-7X2664	75.62
	5J8176		P-UB-10	2-1/2	4-1/4	CTC-7X2664	75.62
LIFT							
	7J7974		P-UB-10	1-1/2	4	CTC-7X2738	73.99
	7J8299		P-UB-10	2-1/2	4	CTC-1318748	130.23
	7J8302		P-UB-10	2-1/2	4	CTC-1318748	130.23
RIPPER							
	2K3663		P-UB-10	2-1/2	7-1/4	CTC-7X2661	153.05
	8J1779		P-UB-10	2-1/2	7-1/4	CTC-1542502	163.63
TILT							
	2J1402		P-UB-10	3	6-1/2	CTC-1318740	146.59
	2J1402		P-UB-10	3	6-1/2	CTC-7X2694	134.38
TRACK ADJUSTER							
			TRK ADJ			CTC-FIG4400	40.63
MODEL D5B							
LIFT							
	7J7974		P-UB-10	1-1/2	4	CTC-7X2738	73.99
	7J8299		P-UB-10	2-1/2	4	CTC-1318748	130.23
	7J8302		P-UB-10	2-1/2	4	CTC-7X2659	132.61
	8J6868		P-UB-10	2-1/2	4	CTC-7X2659	132.61
RIPPER							
	8J1779		P-UB-10	2-1/2	7-1/4	CTC-1542502	163.63
TILT							
	2J1402		P-UB-10	3	6-1/2	CTC-1318733	174.35
	2J1402		P-UB-10	3	6-1/2	CTC-7X2694	134.38
	7J9695		P-UB-10	2-1/2	5-1/2	CTC-9X2050	85.17
TRACK ADJUSTER							
			TRK ADJ			CTC-FIG4400	40.63
MODEL D5C							
ANGLING							
	1363156		P-UB-10	1-1/2	3-1/2	CTC-1327058	87.86
	1390548		P-UB-10	1-1/2	3	CTC-7X2751	54.17
	9J8698		P-UB-10	1-1/2	3-1/2	CTC-1327058	87.86
LIFT							
	1412915		P-UB-10	1-1/2	3-1/2	CTC-1327058	87.86
	7J9223		P-UB-10	1-1/2	3-1/2	CTC-1327058	87.86

CATERPILLAR®



REPLACEMENT KITS FOR CATERPILLAR® EQUIPMENT

Track-Type Tractors							
APPLICATION	CYL #	Misc-Parts, Instructions, etc.	CODE	ROD	BORE	KIT #	List \$
MODEL D5C							
RIPPER							
	7J9920		P-UB-10	2	4	CTC-1328816	78.46
TILT							
	1437219		P-UB-10	1-1/2	3-1/2	CTC-1327058	87.86
	9J8674		P-UB-10	1-1/2	3-1/2	CTC-1327058	87.86
MODEL D5E							
LIFT							
	8J6868		P-UB-10	2-1/2	4	CTC-7X2659	132.61
RIPPER							
	8J1779		P-UB-10	2-1/2	7-1/4	CTC-1542502	163.63
TRACK ADJUSTER							
			TRK ADJ			CTC-FIG4400	40.63
MODEL D5H							
ANGLING							
	4T1666		P-UB-10	2	4	CTC-7X2789	86.29
	9T9273		P-UB-10	2	4	CTC-1113302	100.62
LIFT							
	1153524		P-UB-10	2-1/4	3-3/4	CTC-1361897	134.65
	1U1839		P-UB-10	2-1/4	3-3/4	CTC-1361897	134.65
	1U2568		P-UB-10	2	4-1/4	CTC-7X2819	88.92
	3G5909		P-UB-10	2	4	CTC-7X2789	86.29
	4T1089		P-UB-10	2-1/4	3-3/4	CTC-1361897	134.65
	4T1659		P-UB-10	2-1/4	4-1/2	CTC-1326770	127.03
	6E5400		P-UB-10	2-1/4	4-1/2	CTC-1354392	118.74
RIPPER							
	3G5909		P-UB-10	2	4	CTC-1328816	78.46
	9T2716		P-UB-10	2-1/2	5	CTC-7X2658	147.39
TILT							
	1U3991		P-UB-10	3	6-1/2	CTC-1126550	149.91
	1U3991		P-UB-10	3	6-1/2	CTC-8T1408	68.30
	4T1625		P-UB-10	2-1/4	4-3/4	CTC-1318778	118.51
	4T2613		P-UB-10	2-1/2	5	CTC-1315118	150.48
	4T2613		P-UB-10	2-1/2	5	CTC-7X2658	147.39
MODEL D5M							
ANGLING							
	1061286		P-UB-10	1-3/4	3-1/2	CTC-7X2784	47.66
	1378456		P-UB-10	1-3/4	3-1/2	CTC-7X2784	47.66
	1526482		P-UB-10	1-3/4	3-1/2	CTC-7X2784	47.66
LIFT							
	1059822		P-UB-10	2	4-1/4	CTC-1378662	114.49
	1607610		P-UB-10	2-1/2	4-3/4	CTC-1328811	136.56
	6E0366		P-UB-10	2-1/2	4-3/4	CTC-1328811	136.56
RIPPER							
	3G9892		P-UB-10	2	4	CTC-1328816	78.46
MODEL D5TSKH							
ANGLING							
	9T9273		P-UB-10	2	4	CTC-1113302	100.62



REPLACEMENT KITS FOR CATERPILLAR® EQUIPMENT

Track-Type Tractors							
APPLICATION	CYL #	Misc-Parts, Instructions, etc.	CODE	ROD	BORE	KIT #	List \$
MODEL D5TSKH							
LIFT							
	6E0366		P-UB-10	2-1/2	4-3/4	CTC-1328811	136.56
MODEL D6							
RIPPER							
	2K3663		P-UB-10	2-1/2	7-1/4	CTC-7X2661	153.05
RIPPER LIFT							
	8J1779		P-UB-10	2-1/2	7-1/4	CTC-7X2661	153.05
MODEL D6 LGP							
LIFT							
	8J6868		P-UB-10	2-1/2	4	CTC-7X2659	132.61
MODEL D6B							
LIFT							
	5J8173		P-UB-10	2-1/2	4-1/4	CTC-7X2664	75.62
RIPPER							
	2K3663		P-UB-10	2-1/2	7-1/4	CTC-7X2661	153.05
RIPPER LIFT							
	8J1779		P-UB-10	2-1/2	7-1/4	CTC-7X2661	153.05
TILT							
	2J1402		P-UB-10	3	6-1/2	CTC-1318733	174.35
	2J1402		P-UB-10	3	6-1/2	CTC-7X2694	134.38
TRACK ADJUSTER							
			TRK ADJ			CTC-FIG4400	40.63
MODEL D6C							
BACKHOE STICK/BLADE SHIFT							
	8J5448		P-UB-10	2	4	CTC-1328816	78.46
DOZER							
	5J8172		P-UB-10	2-1/2	4-1/4	CTC-7X2664	75.62
	5J8173		P-UB-10	2-1/2	4-1/4	CTC-7X2664	75.62
DOZER LIFT							
	4J4891		P-U-10	2	3-1/2	CTC-7X2806	102.63
DOZER TILT							
	1U3495		P-UB-10	2-1/2	6	CTC-7X2674	109.31
	2J1402		P-UB-10	3	6-1/2	CTC-7X2694	134.38
	5J1603		P-V-10	2	4-3/4	CTC-7X2677	99.00
	7J3171		P-UB-10	2-1/2	6	CTC-7X2674	109.31
	7J3172		P-UB-10	2-1/2	6	CTC-7X2674	109.31
LIFT							
	7J7974		P-UB-10	1-1/2	4	CTC-7X2738	73.99
	7J8302		P-UB-10	2-1/2	4	CTC-1318748	130.23
	8J6868		P-UB-10	2-1/2	4	CTC-1318748	130.23
RIPPER							
	2K3663		P-UB-10	2-1/2	7-1/4	CTC-7X2661	153.05
	6J3308		P-UB-10	2-1/2	5-1/2	CTC-8T1374	79.00
	8J1779		P-UB-10	2-1/2	7-1/4	CTC-1542502	163.63
TILT							
	2J1402		P-UB-10	3	6-1/2	CTC-1318733	174.35

CATERPILLAR®



REPLACEMENT KITS FOR CATERPILLAR® EQUIPMENT

Track-Type Tractors							
APPLICATION	CYL #	Misc-Parts, Instructions, etc.	CODE	ROD	BORE	KIT #	List \$
MODEL D6C							
TRACK ADJUSTER							
			TRK ADJ			CTC-FIG3400	50.60
MODEL D6D							
BACKHOE STICK/BLADE SHIFT							
	8J5448		P-UB-10	2	4	CTC-1328816	78.46
DOZER TILT							
	1U3495		P-UB-10	2-1/2	6	CTC-7X2674	109.31
	2J1402		P-UB-10	3	6-1/2	CTC-7X2694	134.38
	7J3171		P-UB-10	2-1/2	6	CTC-7X2674	109.31
	7J3172		P-UB-10	2-1/2	6	CTC-7X2674	109.31
DOZER TILT RH							
	7J9695		P-UB-10	2-1/2	5-1/2	CTC-8T1374	79.00
LIFT							
	7J7974		P-UB-10	1-1/2	4	CTC-7X2738	73.99
	7J8302		P-UB-10	2-1/2	4	CTC-1318748	130.23
	8J6868		P-UB-10	2-1/2	4	CTC-1318748	130.23
RIPPER							
	8J1779		P-UB-10	2-1/2	7-1/4	CTC-1542502	163.63
TILT							
	1U3495		P-UB-10	2-1/2	6	CTC-7X2692	138.95
	2J1402		P-UB-10	3	6-1/2	CTC-1318733	174.35
	7J3171		P-UB-10	2-1/2	6	CTC-7X2692	138.95
	7J9695		P-UB-10	2-1/2	5-1/2	CTC-9X2050	85.17
	9T2797		P-UB-10	2-1/2	6	CTC-7X2674	109.31
TILT LH							
	6J0518		P-UB-10	2-1/2	6	CTC-7X2692	138.95
	7J3172		P-UB-10	2-1/2	6	CTC-7X2692	138.95
TILT RH							
	6J0517		P-UB-10	2-1/2	6	CTC-7X2692	138.95
TRACK ADJUSTER							
			TRK ADJ			CTC-FIG3400	50.60
MODEL D6E, D6G							
LIFT							
	8J6868		P-UB-10	2-1/2	4	CTC-1318748	130.23
RIPPER							
	1306135		P-UB-10	2-1/2	7-1/4	CTC-1542502	163.63
	8J1779		P-UB-10	2-1/2	7-1/4	CTC-1542502	163.63
TILT							
	1U3495		P-UB-10	2-1/2	6	CTC-7X2674	109.31
	1U3495		P-UB-10	2-1/2	6	CTC-7X2692	138.95
	9T2797		P-UB-10	2-1/2	6	CTC-7X2674	109.31
UNSPECIFIED APPLICATION							
	2J1402		P-UB-10	3	6-1/2	CTC-1318733	174.35

CATERPILLAR®



REPLACEMENT KITS FOR CATERPILLAR® EQUIPMENT

Track-Type Tractors							
APPLICATION	CYL #	Misc-Parts, Instructions, etc.	CODE	ROD	BORE	KIT #	List \$
MODEL D6H							
DOZER							
	1U3989		P-UB-10	2-1/2	3-3/4	CTC-1318700	127.66
	1U3990		P-UB-10	2-1/2	3-3/4	CTC-1318700	127.66
	4Y3807		P-UB-10	2-1/2	3-3/4	CTC-1318700	127.66
	9T8952		P-UB-10	2-1/2	4	CTC-1353223	135.69
	9T8996		P-UB-10	2-1/2	4	CTC-1353223	135.69
DOZER TILT							
	9T6095		P-UB-10	2-1/2	6	CTC-7X2655	96.10
RIPPER							
	9T2716		P-UB-10	2-1/2	5	CTC-7X2658	147.39
TILT							
	1U3991		P-UB-10	3	6-1/2	CTC-1126550	149.91
	1U3991		P-UB-10	3	6-1/2	CTC-7X2694	134.38
	1U3992		P-UB-10	2-1/2	6	CTC-7X2655	96.10
	1U3992		P-UB-14	2-1/2	6	CTC-7X2836	217.33
	3G2798		P-UB-10	2-1/2	5-1/2	CTC-7X2671	125.31
	9T6095		P-UB-10	2-1/2	6	CTC-1315164	172.08
	9T8760		P-UB-10	2	4-1/4	CTC-7X2766	37.33
MODEL D6M							
ANGLING							
	1103786		P-UB-10	2	4	CTC-1113302	100.62
	1526485		P-UB-10	2	4	CTC-1113302	100.62
LIFT							
	1103269		P-UB-10	2-1/4	4-1/2	CTC-1326770	127.03
	1153524		P-UB-10	2-1/4	3-3/4	CTC-1361897	134.65
RIPPER							
	3G5909		P-UB-10	2	4	CTC-1328816	78.46
	9T2716		P-UB-10	2-1/2	5	CTC-7X2658	147.39
TILT							
	1600054		P-UB-10	2-1/2	5-1/2	CTC-7X2653	137.42
UNSPECIFIED APPLICATION							
	1375107		P-UB-10	2	4	CTC-1113302	100.62
MODEL D6R							
DOZER							
	1278931		P-UB-10	2-1/2	4	CTC-1353223	135.69
	1294258		P-UB-10	2-1/2	4	CTC-1353223	135.69
RIPPER							
	9T2716		P-UB-10	2-1/2	5	CTC-7X2658	147.39
TILT							
	1U3991		P-UB-10	3	6-1/2	CTC-1126550	149.91
	1U3991		P-UB-10	3	6-1/2	CTC-8T1408	68.30
	9T6095		P-UB-10	2-1/2	6	CTC-1315164	172.08
	9T6095		P-UB-10	2-1/2	6	CTC-7X2655	96.10
MODEL D7							
TRACK ADJUSTER							
			TRK ADJ			CTC-FIG3400	50.60

CATERPILLAR®



REPLACEMENT KITS FOR CATERPILLAR® EQUIPMENT

Track-Type Tractors							
APPLICATION	CYL #	Misc-Parts, Instructions, etc.	CODE	ROD	BORE	KIT #	List \$
MODEL D7 LGP							
LIFT LH							
	9J4887		P-UB-10	2-1/2	4-3/4	CTC-1014201	113.34
LIFT RH							
	9J4888		P-UB-10	2-1/2	4-3/4	CTC-1014201	113.34
MODEL D7A, D7B, D7C, D7D, D7E							
DOZER LIFT							
	3R6781		P-UB-10	2-1/2	4-3/4	CTC-7X2660	151.93
DOZER LIFT LH							
	1U2133		P-UB-10	2-1/2	4-3/4	CTC-7X2660	151.93
	1U2136		P-UB-10	2-1/2	4-3/4	CTC-7X2660	151.93
DOZER LIFT RH							
	1U2134		P-UB-10	2-1/2	4-3/4	CTC-7X2660	151.93
	1U2135		P-UB-10	2-1/2	4-3/4	CTC-7X2660	151.93
DOZER TILT							
	2J6783		P-U-10	3-1/2	8-1/4	CTC-7X2720	152.83
	3J9694		P-U-10	3-1/2	8-1/4	CTC-7X2720	152.83
	3R6770		P-U-10	3-1/2	8-1/4	CTC-7X2720	152.83
	9J8748		P-UB-10	3	6-1/2	CTC-7X2694	134.38
LIFT							
	3J3271		P-UB-10	2-1/2	6	CTC-7X2679	116.87
	4J6177		P-UB-10	2-1/2	4-3/4	CTC-1014201	113.34
	4J6177		P-UB-10	2-1/2	4-3/4	CTC-7X2660	151.93
RIPPER							
	3J6439		P-UB-10	2-1/2	6	CTC-7X2679	116.87
RIPPER LIFT							
	3R6724	D7E only	P-UB-10	2-1/2	6	CTC-7X2679	116.87
	4T9290		P-UB-10	2-1/2	6	CTC-7X2655	96.10
TILT							
	5J7929		P-UB-10	2-1/2	6	CTC-7X2692	138.95
	6J9752		P-UB-10	3	6-1/2	CTC-1126550	149.91
TRACK ADJUSTER							
		D7C, D7D only	TRK ADJ			CTC-FIG3400	50.60
		D7E only	TRK ADJ			CTC-FIG3404	33.91
MODEL D7F							
DOZER LH							
	1041944		P-UB-10	2-1/2	4-3/4	CTC-1700221	119.82
	1U2136		P-UB-10	2-1/2	4-3/4	CTC-7X2773	150.91
DOZER LIFT							
	3R6781		P-UB-10	2-1/2	4-3/4	CTC-7X2660	151.93
DOZER LIFT LH							
	1U2133		P-UB-10	2-1/2	4-3/4	CTC-7X2660	151.93
	1U2136		P-UB-10	2-1/2	4-3/4	CTC-7X2660	151.93
DOZER LIFT RH							
	1U2134		P-UB-10	2-1/2	4-3/4	CTC-7X2660	151.93
	1U2135		P-UB-10	2-1/2	4-3/4	CTC-7X2660	151.93

CATERPILLAR®



REPLACEMENT KITS FOR CATERPILLAR® EQUIPMENT

Track-Type Tractors							
APPLICATION	CYL #	Misc-Parts, Instructions, etc.	CODE	ROD	BORE	KIT #	List \$
MODEL D7F							
DOZER RH							
	1041943		P-UB-10	2-1/2	4-3/4	CTC-1700221	119.82
	1U2135		P-UB-10	2-1/2	4-3/4	CTC-7X2773	150.91
DOZER TILT							
	2J6783		P-U-10	3-1/2	8-1/4	CTC-7X2720	152.83
	3J9694		P-U-10	3-1/2	8-1/4	CTC-7X2720	152.83
	3R6770		P-U-10	3-1/2	8-1/4	CTC-7X2720	152.83
	9J8748		P-UB-10	3	6-1/2	CTC-7X2694	134.38
LIFT							
	3J3271		P-UB-10	2-1/2	6	CTC-7X2679	116.87
	4J6177		P-UB-10	2-1/2	4-3/4	CTC-7X2660	151.93
LIFT LH							
	7J3334		P-UB-10	2-1/2	4-3/4	CTC-7X2773	150.91
LIFT RH							
	7J3333		P-UB-10	2-1/2	4-3/4	CTC-7X2773	150.91
RIPPER							
	3J6439		P-UB-10	2-1/2	6	CTC-7X2679	116.87
RIPPER LIFT							
	3R6724		P-UB-10	2-1/2	6	CTC-7X2679	116.87
	4T9290		P-UB-10	2-1/2	6	CTC-7X2655	96.10
TILT							
	5J7929		P-UB-10	2-1/2	6	CTC-7X2692	138.95
	6J9752		P-UB-10	3	6-1/2	CTC-1126550	149.91
	9J8748		P-UB-10	3	6-1/2	CTC-1126550	149.91
TRACK ADJUSTER							
			TRK ADJ			CTC-FIG3401	47.23
MODEL D7G							
DOZER LH							
	1041944		P-UB-10	2-1/2	4-3/4	CTC-1700221	119.82
	1U2133		P-UB-10	2-1/2	4-3/4	CTC-7X2773	150.91
	1U2136		P-UB-10	2-1/2	4-3/4	CTC-7X2773	150.91
DOZER LIFT							
	3R6781		P-UB-10	2-1/2	4-3/4	CTC-7X2660	151.93
DOZER LIFT LH							
	1U2133		P-UB-10	2-1/2	4-3/4	CTC-7X2660	151.93
	1U2136		P-UB-10	2-1/2	4-3/4	CTC-7X2660	151.93
DOZER LIFT RH							
	1U2134		P-UB-10	2-1/2	4-3/4	CTC-7X2660	151.93
	1U2135		P-UB-10	2-1/2	4-3/4	CTC-7X2660	151.93
DOZER RH							
	1041943		P-UB-10	2-1/2	4-3/4	CTC-1700221	119.82
	1U2134		P-UB-10	2-1/2	4-3/4	CTC-7X2773	150.91
	1U2135		P-UB-10	2-1/2	4-3/4	CTC-7X2773	150.91

CATERPILLAR®



REPLACEMENT KITS FOR CATERPILLAR® EQUIPMENT

Track-Type Tractors							
APPLICATION	CYL #	Misc-Parts, Instructions, etc.	CODE	ROD	BORE	KIT #	List \$
MODEL D7G							
DOZER TILT							
	2J6783		P-U-10	3-1/2	8-1/4	CTC-7X2720	152.83
	3J9694		P-U-10	3-1/2	8-1/4	CTC-7X2720	152.83
	3R6770		P-U-10	3-1/2	8-1/4	CTC-7X2720	152.83
	9J8748		P-UB-10	3	6-1/2	CTC-7X2694	134.38
LIFT							
	3J3271		P-UB-10	2-1/2	6	CTC-7X2679	116.87
	3R6781		P-UB-10	2-1/2	4-3/4	CTC-7X2660	151.93
	4J6177		P-UB-10	2-1/2	4-3/4	CTC-1014201	113.34
	4J6177		P-UB-10	2-1/2	4-3/4	CTC-7X2660	151.93
LIFT LH							
	7J3334		P-UB-10	2-1/2	4-3/4	CTC-7X2773	150.91
LIFT RH							
	7J3333		P-UB-10	2-1/2	4-3/4	CTC-7X2773	150.91
	9J4888		P-UB-10	2-1/2	4-3/4	CTC-7X2773	150.91
RIPPER							
	3J6439		P-UB-10	2-1/2	6	CTC-7X2679	116.87
RIPPER LIFT							
	4T9290		P-UB-10	2-1/2	6	CTC-7X2655	96.10
TILT							
	2J1402		P-UB-10	3	6-1/2	CTC-1318733	174.35
	5J7929		P-UB-10	2-1/2	6	CTC-7X2692	138.95
	6J9752		P-UB-10	3	6-1/2	CTC-1126550	149.91
	9J8748		P-UB-10	3	6-1/2	CTC-1126550	149.91
	9J8748		P-UB-10	3	6-1/2	CTC-8T1408	68.30
TILT LH							
	5J7930		P-UB-10	2-1/2	6	CTC-7X2692	138.95
	7J9364		P-UB-10	2-1/2	6	CTC-7X2669	197.74
TRACK ADJUSTER							
			TRK ADJ			CTC-FIG3401	47.23
MODEL D7H							
DOZER							
	1291908		P-UB-10	2-1/2	4	CTC-1353223	135.69
	1U4851		P-UB-10	2-1/2	4	CTC-1353253	133.34
	1U4852		P-UB-10	2-1/2	4	CTC-1353253	133.34
DOZER LIFT							
	1U3989		P-UB-10	2-1/2	3-3/4	CTC-7X2670	77.50
	1U4851		P-UB-10	2-1/2	4	CTC-1318748	130.23
	1U4852		P-UB-10	2-1/2	4	CTC-1318748	130.23
DOZER TILT							
	3G4533		P-UB-10	3	6-1/2	CTC-7X2694	134.38
	9T1370		P-UB-10	3	6-1/2	CTC-7X2694	134.38

CATERPILLAR®



REPLACEMENT KITS FOR CATERPILLAR® EQUIPMENT

Track-Type Tractors							
APPLICATION	CYL #	Misc-Parts, Instructions, etc.	CODE	ROD	BORE	KIT #	List \$
MODEL D7H							
LIFT							
	1294259		P-UB-10	2-1/2	4	CTC-1353223	135.69
	1U4852		P-UB-10	2-1/2	4	CTC-7X2659	132.61
	4T2098		P-UB-10	2-1/2	4-3/4	CTC-7X2673	150.91
	6E1836		P-UB-10	2-1/2	4	CTC-1353223	135.69
	6E1841		P-UB-10	2-1/2	4	CTC-1353223	135.69
RIPPER							
	4T8639		P-UB-10	2-3/4	5-1/4	CTC-1326121	177.27
	9T0142		P-UB-10	3	7-1/4	CTC-1326184	191.08
TILT							
	1124814		P-UB-10	2-3/4	6	CTC-1352167	178.13
	3G4533		P-UB-10	3	6-1/2	CTC-1126550	149.91
	6J9752		P-UB-10	3	6-1/2	CTC-1126550	149.91
	9T6113		P-UB-10	3	6-1/2	CTC-1126550	149.91
MODEL D7R							
DOZER							
	1291908		P-UB-10	2-1/2	4	CTC-1353223	135.69
	1U4851		P-UB-10	2-1/2	4	CTC-1318748	130.23
	1U4851		P-UB-10	2-1/2	4	CTC-1353253	133.34
	1U4852		P-UB-10	2-1/2	4	CTC-1318748	130.23
	1U4852		P-UB-10	2-1/2	4	CTC-1353253	133.34
LIFT							
	1294259		P-UB-10	2-1/2	4	CTC-1353223	135.69
	6E1836		P-UB-10	2-1/2	4	CTC-1353223	135.69
	6E1841		P-UB-10	2-1/2	4	CTC-1353223	135.69
RIPPER							
	9T0142		P-UB-10	3	7-1/4	CTC-1326184	191.08
TILT							
	1124814		P-UB-10	2-3/4	6	CTC-1352167	178.13
	3G4533		P-UB-10	3	6-1/2	CTC-1126550	149.91
	9T6113		P-UB-10	3	6-1/2	CTC-1126550	149.91
TILT LH							
	1470709		P-UB-10	3	6-1/2	CTC-1126550	149.91
TILT RH							
	1470708		P-UB-10	3	6-1/2	CTC-1126550	149.91
MODEL D8							
DOZER LIFT LH							
	3G8089		P-UB-10	2-3/4	5	CTC-7X2682	132.07
	8J8585		P-UB-10	2-3/4	5	CTC-7X2824	100.59
DOZER LIFT RH							
	3G8090		P-UB-10	2-3/4	5	CTC-7X2682	132.07
	8J8584		P-UB-10	2-3/4	5	CTC-7X2824	100.59
DOZER TILT							
	2J3894		P-U-10	3-1/2	8-1/4	CTC-7X2720	152.83

CATERPILLAR®



REPLACEMENT KITS FOR CATERPILLAR® EQUIPMENT

Track-Type Tractors							
APPLICATION	CYL #	Misc-Parts, Instructions, etc.	CODE	ROD	BORE	KIT #	List \$
MODEL D8							
LIFT							
	2J2470		P-UB-10	2-1/2	6	CTC-7X2679	116.87
	3J2189		P-UB-10	2-1/2	6	CTC-7X2679	116.87
	5J1243		P-UB-10	2-1/2	6	CTC-7X2679	116.87
	5J2815		P-UB-10	2-1/2	6	CTC-7X2679	116.87
LIFT LH							
	5J9378		P-UB-10	2-1/2	5	CTC-7X2675	105.11
	8J8585		P-UB-10	2-3/4	5	CTC-7X2824	100.59
LIFT RH							
	5J9708		P-UB-10	2-1/2	5	CTC-7X2675	105.11
PIN PULLER							
	4J5057		P-V-10	1-1/4	4	CTC-8T1480	69.97
RIPPER							
	6J9129		P-UB-10	3	7-1/4	CTC-7X2702	240.14
RIPPER LIFT LH							
	7J3222		P-UB-10	3-1/4	8-1/4	CTC-7X2715	224.12
	7J3222		P-UB-10	3-1/4	8-1/4	CTC-7X2801	206.70
RIPPER LIFT RH							
	7J3221		P-UB-10	3-1/4	8-1/4	CTC-7X2715	224.12
	7J3221		P-UB-10	3-1/4	8-1/4	CTC-7X2801	206.70
RIPPER PIN PULLER							
	7J0508		P-V-10	1-1/4	4	CTC-8T1480	69.97
	8J2071		P-UB-10	1-1/2	4	CTC-7X2738	73.99
TILT							
	6J2472		P-UB-10	3-1/2	8-1/4	CTC-7X2728	147.99
	7J0192		P-UB-10	3-1/2	8-1/4	CTC-7X2721	246.28
	8J8682		P-UB-10	3-1/2	8-1/4	CTC-7X2721	246.28
TRACK ADJUSTER							
			TRK ADJ			CTC-FIG2400	64.99
MODEL D8H							
ANGLING							
	3J2189		P-UB-10	2-1/2	6	CTC-7X2679	116.87
DOZER							
	2J3894		P-U-10	3-1/2	8-1/4	CTC-7X2720	152.83
	5J2815		P-UB-10	2-1/2	6	CTC-7X2679	116.87
LIFT							
	2J2470		P-UB-10	2-1/2	6	CTC-7X2679	116.87
	3J2189		P-UB-10	2-1/2	6	CTC-7X2679	116.87
	5J1243		P-UB-10	2-1/2	6	CTC-7X2679	116.87
LIFT LH							
	5J9378		P-UB-10	2-1/2	5	CTC-7X2675	105.11
LIFT RH							
	5J9708		P-UB-10	2-1/2	5	CTC-7X2675	105.11
PIN PULLER							
	4J5057		P-V-10	1-1/4	4	CTC-8T1480	69.97
	7J0508		P-V-10	1-1/4	4	CTC-8T1480	69.97
	8J2071		P-UB-10	1-1/2	4	CTC-7X2738	73.99



REPLACEMENT KITS FOR CATERPILLAR® EQUIPMENT

Track-Type Tractors							
APPLICATION	CYL #	Misc-Parts, Instructions, etc.	CODE	ROD	BORE	KIT #	List \$
MODEL D8H							
RIPPER							
	6J9129		P-UB-10	3	7-1/4	CTC-7X2702	240.14
	7J3222		P-UB-10	3-1/4	8-1/4	CTC-7X2715	224.12
RIPPER LIFT LH							
	7J3222		P-UB-10	3-1/4	8-1/4	CTC-7X2715	224.12
	7J3222		P-UB-10	3-1/4	8-1/4	CTC-7X2801	206.70
RIPPER LIFT RH							
	7J3221		P-UB-10	3-1/4	8-1/4	CTC-7X2715	224.12
RIPPER PIN PULLER							
	7J0508		P-V-10	1-1/4	4	CTC-8T1480	69.97
RIPPER RH							
	7J3221		P-UB-10	3-1/4	8-1/4	CTC-7X2801	206.70
TILT							
	6J2472		P-UB-10	3-1/2	8-1/4	CTC-7X2728	147.99
	7J0192		P-UB-10	3-1/2	8-1/4	CTC-1371974	215.86
	7J0192		P-UB-10	3-1/2	8-1/4	CTC-7X2721	246.28
TRACK ADJUSTER							
			TRK ADJ			CTC-FIG1401	86.03
MODEL D8K							
DOZER LIFT LH							
	3G8089		P-UB-10	2-3/4	5	CTC-7X2682	132.07
	8J8585		P-UB-10	2-3/4	5	CTC-7X2824	100.59
DOZER LIFT RH							
	3G8090		P-UB-10	2-3/4	5	CTC-7X2682	132.07
	8J8584		P-UB-10	2-3/4	5	CTC-7X2824	100.59
PIN PULLER							
	7J0508		P-V-10	1-1/4	4	CTC-8T1480	69.97
	8J2071		P-UB-10	1-1/2	4	CTC-7X2738	73.99
RIPPER							
	6J9129		P-UB-10	3	7-1/4	CTC-7X2702	240.14
	7J3222		P-UB-10	3-1/4	8-1/4	CTC-7X2715	224.12
RIPPER LIFT LH							
	7J3222		P-UB-10	3-1/4	8-1/4	CTC-7X2715	224.12
	7J3222		P-UB-10	3-1/4	8-1/4	CTC-7X2801	206.70
RIPPER LIFT RH							
	7J3221		P-UB-10	3-1/4	8-1/4	CTC-7X2715	224.12
	7J3221		P-UB-10	3-1/4	8-1/4	CTC-7X2801	206.70
RIPPER PIN PULLER							
	8J2071		P-UB-10	1-1/2	4	CTC-7X2738	73.99
TILT							
	7J0192		P-UB-10	3-1/2	8-1/4	CTC-7X2721	246.28
	8J8682		P-UB-10	3-1/2	8-1/4	CTC-1371974	215.86
MODEL D8L							
DOZER							
	9J8802		P-UB-10	3-1/2	7-1/2	CTC-7X2722	157.13

CATERPILLAR®



REPLACEMENT KITS FOR CATERPILLAR® EQUIPMENT

Track-Type Tractors							
APPLICATION	CYL #	Misc-Parts, Instructions, etc.	CODE	ROD	BORE	KIT #	List \$
MODEL D8L							
DOZER LIFT							
	9J8802		P-UB-10	3-1/2	7-1/2	CTC-7X2722	157.13
	9T2860		P-UB-10	3	5-1/4	CTC-7X2756	106.96
DOZER TILT							
	3G5707		P-UB-10	3-1/2	8-1/4	CTC-7X2721	246.28
LIFT							
	3G8537		P-UB-10	3	5-1/4	CTC-7X2756	106.96
	9T2860		P-UB-10	3	5-1/4	CTC-7X2756	106.96
PIN PULLER							
	1U3373		P-UB-10	1-1/2	4	CTC-7X2738	73.99
RIPPER							
	3G6457		P-UB-10	3-1/4	8-1/4	CTC-7X2715	224.12
RIPPER LIFT							
	3G6457		P-UB-10	3-1/4	8-1/4	CTC-7X2715	224.12
RIPPER PIN PULLER							
	1U3373		P-UB-10	1-1/2	4	CTC-7X2738	73.99
TILT							
	3G5707		P-UB-10	3-1/2	8-1/4	CTC-1371974	215.86
MODEL D8N							
DOZER							
	6E1102		P-UB-10	3	4-1/2	CTC-1353802	139.46
	6E1175		P-UB-10	3-1/2	7-1/4	CTC-1309483	264.19
	9T0140		P-UB-10	2-3/4	4-1/4	CTC-7X2451	93.80
	9T0141		P-UB-10	3-1/2	7-1/2	CTC-7X2722	157.13
PIN PULLER							
	6E3113		P-UB-10	1-3/4	4	CTC-1316108	91.89
	9T2066		P-UB-10	1-1/2	4	CTC-7X2738	73.99
RIPPER							
	9T0142		P-UB-10	3	7-1/4	CTC-1326184	191.08
	9T0143		P-UB-10	3	6-1/2	CTC-1279809	195.81
TILT							
	6E0397		P-UB-10	3	7-1/4	CTC-1326127	175.93
	9T6077		P-UB-10	3	6-1/2	CTC-1126550	149.91
MODEL D8R							
DOZER							
	6E1102		P-UB-10	3	4-1/2	CTC-1353802	139.46
	6E1175		P-UB-10	3-1/2	7-1/4	CTC-1309483	264.19
PIN PULLER							
	6E3113		P-UB-10	1-3/4	4	CTC-1316108	91.89
	9T2066		P-UB-10	1-1/2	4	CTC-7X2738	73.99
RIPPER							
	4Z6313		P-UB-10	3	6-1/2	CTC-1279809	195.81
	9T0142		P-UB-10	3	7-1/4	CTC-1326184	191.08
	9T0143		P-UB-10	3	6-1/2	CTC-1279809	195.81
TILT							
	6E0397		P-UB-10	3	7-1/4	CTC-1326127	175.93

CATERPILLAR®



REPLACEMENT KITS FOR CATERPILLAR® EQUIPMENT

Track-Type Tractors							
APPLICATION	CYL #	Misc-Parts, Instructions, etc.	CODE	ROD	BORE	KIT #	List \$
MODEL D9D							
TRACK ADJUSTER							
			TRK ADJ			CTC-FIG0401	79.31
MODEL D9G							
DOZER TILT							
	2J6705		P-U-10	3-1/2	8-1/4	CTC-7X2720	152.83
LIFT LH							
	7J1488		P-UB-10	3-1/4	9-1/4	CTC-7X2707	292.80
LIFT RH							
	7J1487		P-UB-10	3-1/4	9-1/4	CTC-7X2707	292.80
PIN PULLER							
	4J5057		P-V-10	1-1/4	4	CTC-8T1480	69.97
	7J0508		P-V-10	1-1/4	4	CTC-8T1480	69.97
	8J2071		P-UB-10	1-1/2	4	CTC-7X2738	73.99
RIPPER							
	6J7810		P-UB-10	3-1/2	8-1/4	CTC-7X2725	329.13
RIPPER LIFT LH							
	7J1488		P-UB-10	3-1/4	9-1/4	CTC-7X2707	292.80
RIPPER LIFT RH							
	7J1487		P-UB-10	3-1/4	9-1/4	CTC-7X2707	292.80
RIPPER PIN PULLER							
	8J2071		P-UB-10	1-1/2	4	CTC-7X2738	73.99
RIPPER TILT							
	6J7810		P-UB-10	3-1/2	8-1/4	CTC-7X2725	329.13
TILT							
	6J1570		P-UB-10	3-1/2	8-1/4	CTC-1371974	215.86
	6J1570		P-UB-10	3-1/2	8-1/4	CTC-7X2721	246.28
TRACK ADJUSTER							
			TRK ADJ			CTC-FIG0401	79.31
			TRK ADJ			CTC-FIG0402	93.45
MODEL D9H							
DOZER LH							
	3G1174		P-UB-10	3	6-1/4	CTC-7X2697	133.81
	3G1177		P-UB-10	3	6-1/4	CTC-7X2697	133.81
DOZER RH							
	3G1175		P-UB-10	3	6-1/4	CTC-7X2697	133.81
	3G1176		P-UB-10	3	6-1/4	CTC-7X2697	133.81
LIFT LH							
	3G1174		P-UB-10	3	6-1/4	CTC-7X2697	133.81
	3G1177		P-UB-10	3	6-1/4	CTC-7X2697	133.81
	7J1488		P-UB-10	3-1/4	9-1/4	CTC-1895377	203.95
	7J1488		P-UB-10	3-1/4	9-1/4	CTC-7X2707	292.80
LIFT RH							
	3G1175		P-UB-10	3	6-1/4	CTC-7X2697	133.81
	3G1176		P-UB-10	3	6-1/4	CTC-7X2697	133.81
	7J1487		P-UB-10	3-1/4	9-1/4	CTC-1895377	203.95
	7J1487		P-UB-10	3-1/4	9-1/4	CTC-7X2707	292.80

CATERPILLAR®



REPLACEMENT KITS FOR CATERPILLAR® EQUIPMENT

Track-Type Tractors							
APPLICATION	CYL #	Misc-Parts, Instructions, etc.	CODE	ROD	BORE	KIT #	List \$
MODEL D9H							
PIN PULLER							
	8J2071		P-UB-10	1-1/2	4	CTC-7X2738	73.99
RIPPER							
	6J7810		P-UB-10	3-1/2	8-1/4	CTC-7X2725	329.13
RIPPER LIFT LH							
	7J1488		P-UB-10	3-1/4	9-1/4	CTC-7X2707	292.80
RIPPER LIFT RH							
	7J1487		P-UB-10	3-1/4	9-1/4	CTC-7X2707	292.80
RIPPER PIN PULLER							
	8J2071		P-UB-10	1-1/2	4	CTC-7X2738	73.99
RIPPER TILT							
	6J7810		P-UB-10	3-1/2	8-1/4	CTC-7X2725	329.13
TILT							
	6J1570		P-UB-10	3-1/2	8-1/4	CTC-1371974	215.86
	6J1570		P-UB-10	3-1/2	8-1/4	CTC-7X2721	246.28
MODEL D9L							
DOZER TILT							
	3G8661		P-UB-10	4	9-1/4	CTC-7X2799	302.65
	4T4248		P-UB-10	4	9-1/4	CTC-7X2799	302.65
LIFT							
	9J5868		P-UB-10	3-1/4	6	CTC-7X2757	226.37
PIN PULLER							
	1U3373		P-UB-10	1-1/2	4	CTC-7X2738	73.99
RIPPER LIFT							
	4T0979		P-UB-10	3-1/4	9-1/4	CTC-7X2707	292.80
RIPPER LIFT LH							
	4T5111		P-UB-10	3-1/4	9-1/4	CTC-7X2707	292.80
RIPPER LIFT RH							
	4T5112		P-UB-10	3-1/4	9-1/4	CTC-7X2707	292.80
RIPPER PIN PULLER							
	1U3373		P-UB-10	1-1/2	4	CTC-7X2738	73.99
RIPPER TILT							
	4T6970		P-UB-10	3-1/4	8-1/4	CTC-7X2715	224.12
	4T9977		P-UB-10	3-1/4	8-1/4	CTC-7X2715	224.12
MODEL D9N							
DOZER LIFT							
	9T2860		P-UB-10	3	5-1/4	CTC-7X2756	106.96
DOZER TILT							
	3G5707		P-UB-10	3-1/2	8-1/4	CTC-7X2721	246.28
LIFT							
	9T2860		P-UB-10	3	5-1/4	CTC-7X2756	106.96
PIN PULLER							
	6E3113		P-UB-10	1-3/4	4	CTC-1316108	91.89
	9T2066		P-UB-10	1-1/2	4	CTC-7X2738	73.99
RIPPER							
	3G6457		P-UB-10	3-1/4	8-1/4	CTC-7X2715	224.12



REPLACEMENT KITS FOR CATERPILLAR® EQUIPMENT

Track-Type Tractors							
APPLICATION	CYL #	Misc-Parts, Instructions, etc.	CODE	ROD	BORE	KIT #	List \$
MODEL D9N							
RIPPER LIFT							
	3G6457		P-UB-10	3-1/4	8-1/4	CTC-7X2715	224.12
RIPPER PIN PULLER							
	9T2066		P-UB-10	1-1/2	4	CTC-7X2738	73.99
TILT							
	3G5707		P-UB-10	3-1/2	8-1/4	CTC-1371974	215.86
	6E4835	1229350 Piston	P-UB-10	3-1/2	8-1/4	CTC-1324905	177.60
	6E4836	1229350 Piston	P-UB-10	3-1/2	8-1/4	CTC-1324905	177.60
MODEL D9R							
DOZER							
	6E4433		P-UB-10	3	4-3/4	CTC-1542503	105.86
PIN PULLER							
	6E3113		P-UB-10	1-3/4	4	CTC-1316108	91.89
RIPPER							
	1238098		P-UB-10	3-1/4	7-1/4	CTC-1324987	191.32
	1325123		P-UB-10	3-1/4	7-1/4	CTC-1324987	191.32
	9T5813		P-UB-10	3-1/4	7-1/4	CTC-1324987	191.32
RIPPER TILT							
	1238097		P-UB-10	3	6	CTC-1324937	113.25
	1325149		P-UB-10	3	6	CTC-1324937	113.25
	9T5807		P-UB-10	3	6	CTC-1324937	113.25
TILT							
	1096778		P-UB-10	3-1/2	8-1/4	CTC-1324905	177.60
TILT LH							
	1098833		P-UB-10	3-1/2	8-1/4	CTC-1324905	177.60
	6E4835		P-UB-10	3-1/2	8-1/4	CTC-7X2721	246.28
TILT RH							
	1098832		P-UB-10	3-1/2	8-1/4	CTC-1324905	177.60
	6E4836		P-UB-10	3-1/2	8-1/4	CTC-7X2721	246.28
MODEL D10							
DOZER							
	1U2711		P-UB-10	4	10-1/2	CTC-1324932	305.69
	3G5761		P-UB-10	4	10-1/2	CTC-1324932	305.69
DOZER LH							
	4T3211		P-UB-10	4	10-1/2	CTC-1324932	305.69
DOZER LIFT LH							
	4T2727		P-UB-10	4	7	CTC-8T1457	162.48
	9J2959		P-UB-10	4	7	CTC-1326783	219.74
DOZER LIFT RH							
	4T2728		P-UB-10	4	7	CTC-8T1457	162.48
	9J2958		P-UB-10	4	7	CTC-1326783	219.74
DOZER RH							
	4T3210		P-UB-10	4	10-1/2	CTC-1324932	305.69
PIN PULLER							
	1U3373		P-UB-10	1-1/2	4	CTC-7X2738	73.99
	8J2071		P-UB-10	1-1/2	4	CTC-7X2738	73.99

CATERPILLAR®



REPLACEMENT KITS FOR CATERPILLAR® EQUIPMENT

Track-Type Tractors							
APPLICATION	CYL #	Misc-Parts, Instructions, etc.	CODE	ROD	BORE	KIT #	List \$
MODEL D10							
RIPPER							
	3G2220		P-UB-10	3-1/4	8-1/4	CTC-7X2801	206.70
RIPPER PIN PULLER							
	1U3373		P-UB-10	1-1/2	4	CTC-7X2738	73.99
	8J2071		P-UB-10	1-1/2	4	CTC-7X2738	73.99
RIPPER TILT							
	3G2220		P-UB-10	3-1/4	8-1/4	CTC-7X2801	206.70
MODEL D10N							
DOZER LIFT							
	9T2869		P-UB-10	3-1/2	6-1/4	CTC-7X0863	142.99
DOZER TILT							
	9T1180		P-UB-10	4	9-1/4	CTC-7X2799	302.65
	9T4279		P-UB-10	4	9-1/4	CTC-7X2799	302.65
PIN PULLER							
	6E3113		P-UB-10	1-3/4	4	CTC-1316108	91.89
	9T2066		P-UB-10	1-1/2	4	CTC-7X2738	73.99
RIPPER							
	4T9977		P-UB-10	3-1/4	8-1/4	CTC-7X2715	224.12
RIPPER LH							
	4T5111		P-UB-10	3-1/4	9-1/4	CTC-7X2707	292.80
RIPPER LIFT LH							
	4T5111		P-UB-10	3-1/4	9-1/4	CTC-7X2707	292.80
RIPPER LIFT RH							
	4T5112		P-UB-10	3-1/4	9-1/4	CTC-7X2707	292.80
RIPPER PIN PULLER							
	9T2066		P-UB-10	1-1/2	4	CTC-7X2738	73.99
RIPPER RH							
	4T5112		P-UB-10	3-1/4	9-1/4	CTC-7X2707	292.80
RIPPER TILT							
	4T9977		P-UB-10	3-1/4	8-1/4	CTC-7X2715	224.12
TILT LH							
	9J0673		P-UB-10	2-3/4	6	CTC-7X2803	144.98
TWIN TILT LH							
	9T9204		P-UB-10	4	9-1/4	CTC-7X2799	302.65
TWIN TILT RH							
	9T9203		P-UB-10	4	9-1/4	CTC-7X2799	302.65
MODEL D10R							
PIN PULLER							
	6E3113		P-UB-10	1-3/4	4	CTC-1316108	91.89
RIPPER							
	4T9977		P-UB-10	3-1/4	8-1/4	CTC-7X2715	224.12
RIPPER LH							
	4T5111		P-UB-10	3-1/4	9-1/4	CTC-7X2707	292.80
RIPPER RH							
	4T5112		P-UB-10	3-1/4	9-1/4	CTC-7X2707	292.80

CATERPILLAR®



REPLACEMENT KITS FOR CATERPILLAR® EQUIPMENT

Track-Type Tractors							
APPLICATION	CYL #	Misc-Parts, Instructions, etc.	CODE	ROD	BORE	KIT #	List \$
MODEL D11N							
DOZER LIFT LH							
	4T2727		P-UB-10	4	7	CTC-1326783	219.74
	4T2727		P-UB-10	4	7	CTC-8T1457	162.48
DOZER LIFT RH							
	4T2728		P-UB-10	4	7	CTC-1326783	219.74
	4T2728		P-UB-10	4	7	CTC-8T1457	162.48
DOZER TILT							
	1U2711		P-UB-10	4	10-1/2	CTC-1324932	305.69
	9T1180		P-UB-10	4	9-1/4	CTC-7X2799	302.65
	9T4276		P-UB-10	4	9-1/4	CTC-7X2799	302.65
PIN PULLER							
	6E3113		P-UB-10	1-3/4	4	CTC-1316108	91.89
	6E3113		P-UB-10	1-1/2	4	CTC-7X2738	73.99
	9T2066		P-UB-10	1-1/2	4	CTC-7X2738	73.99
RIPPER							
	4T7985		P-UB-10	3-1/4	8-1/4	CTC-7X2715	224.12
RIPPER PIN PULLER							
	9T2066		P-UB-10	1-1/2	4	CTC-7X2738	73.99
RIPPER TILT							
	3G2220		P-UB-10	3-1/4	8-1/4	CTC-7X2801	206.70
	3G3220		P-UB-10	3-1/4	8-1/4	CTC-7X2715	224.12
	4T7985		P-UB-10	3-1/4	8-1/4	CTC-7X2715	224.12
TILT							
	9T3715		P-UB-10	4	10-1/2	CTC-1324932	305.69
	9T3716		P-UB-10	4	10-1/2	CTC-1324932	305.69
MODEL D11R							
DOZER							
	1U2711		P-UB-10	4	10-1/2	CTC-1324932	305.69
DOZER LH							
	4T2727		P-UB-10	4	7	CTC-1326783	219.74
	4T2727		P-UB-10	4	7	CTC-8T1457	162.48
DOZER RH							
	4T2728		P-UB-10	4	7	CTC-1326783	219.74
	4T2728		P-UB-10	4	7	CTC-8T1457	162.48
PIN PULLER							
	6E3113		P-UB-10	1-3/4	4	CTC-1316108	91.89
	9T2066		P-UB-10	1-1/2	4	CTC-7X2738	73.99
TILT							
	9T3715		P-UB-10	4	10-1/2	CTC-1324932	305.69
	9T3716		P-UB-10	4	10-1/2	CTC-1324932	305.69
Tractors							
APPLICATION	CYL #	Misc-Parts, Instructions, etc.	CODE	ROD	BORE	KIT #	List \$
MODEL 772, 772B							
DOOR							
	3G4640		P-UB-10	2-1/2	6	CTC-7X2669	197.74
	9J8157		P-UB-14	2-1/2	6	CTC-7X2836	217.33

CATERPILLAR®



REPLACEMENT KITS FOR CATERPILLAR® EQUIPMENT

Tractors							
APPLICATION	CYL #	Misc-Parts, Instructions, etc.	CODE	ROD	BORE	KIT #	List \$
MODEL 772, 772B							
HOIST							
	9J2017	772B	I-SP-10	5,7-1/2	8-1/4	CTC-8T9042	385.00
	9T3122	772B	I-SP-10	5,7-1/2	8-1/4	CTC-8T9042	385.00
STEERING							
			P-UB-10	2-3/8	4	CTC-2418925	47.77
SUSPENSION							
	8J2322		P-UB-3	7	8	CTC-1137475	386.82
SUSPENSION FRONT							
	1U4777		P-UB-3	7	8	CTC-1137478	554.50
	7J3480		P-UB-3	7	8	CTC-1137475	386.82
UNSPECIFIED APPLICATION							
	1163092		P-UB-3	7	8	CTC-1137478	554.50
MODEL 776, 776B							
DOOR							
	3G4640		P-UB-10	2-1/2	6	CTC-7X2669	197.74
STEERING							
			P-UB-10	2-3/8	4	CTC-2418925	47.77
SUSPENSION REAR							
	8J8865		I, P-U-13	9	10-1/2	CTC-1137482	302.00
MODEL 776C, 776D							
STEERING							
	8J9912		P-UB-10	2-3/8	4	CTC-8T1389	40.27
SUSPENSION REAR							
	8J8865		I, P-U-13	9	10-1/2	CTC-1137482	302.00
MODEL 784C							
STEERING							
	6E5857		P-UB-10	2-1/2	5	CTC-1304012	161.86
Tree Harvesters							
APPLICATION	CYL #	Misc-Parts, Instructions, etc.	CODE	ROD	BORE	KIT #	List \$
MODEL 518							
TILT LH							
	9T1777		P-UB-10	2-1/4	4-1/4	CTC-7X2750	96.77
TILT RH							
	9T1772		P-UB-10	2-1/4	4-1/4	CTC-7X2750	96.77
Wheel Loaders							
APPLICATION	CYL #	Misc-Parts, Instructions, etc.	CODE	ROD	BORE	KIT #	List \$
MODEL 902							
UNSPECIFIED APPLICATION							
	9T4006		P-UB-10	1-1/2	3	CTC-7X2737	91.86
MODEL 904							
LIFT							
	4T8580		P-UB-10	2	3-3/4	CTC-7X2787	76.39
STEERING							
	1U4666		P-UB-10	1-1/2	2-3/4	CTC-7X2749	49.96
TILT							
	4T8581		P-UB-10	1-3/4	3-1/4	CTC-7X2764	54.01



REPLACEMENT KITS FOR CATERPILLAR® EQUIPMENT

Wheel Loaders							
APPLICATION	CYL #	Misc-Parts, Instructions, etc.	CODE	ROD	BORE	KIT #	List \$
MODEL 906							
BUCKET GRAPPLE							
	1649430		P-UB-10	1-1/4	2-1/2	CTC-1649430K	41.62
LIFT							
	1344485		P-UB-10	55 mm	100 mm	CTC-1344485K	99.80
MULTIPURPOSE BUCKET							
	1349838		P-UB-10	35 mm	70 mm	CTC-1349838K	132.40
	9T4006		P-UB-10	1-1/2	3	CTC-1856583	38.75
SIDE DUMP							
	1250373		P-UB-10	1-1/2	2-3/4	CTC-1856596	39.18
STEERING							
	1349838		P-UB-10	35 mm	70 mm	CTC-1349838K	132.40
STEERING RH							
	1250373		P-UB-10	1-1/2	2-3/4	CTC-1856596	39.18
TILT							
	1350532		P-UB-10	50 mm	85 mm	CTC-1350532K	181.87
MODEL 908							
HIGH DUMP							
	1349848		P-UB-10	35 mm	70 mm	CTC-1349838K	132.40
MULTIPURPOSE BUCKET							
	9T4006		P-UB-10	1-1/2	3	CTC-1856583	38.75
SIDE DUMP							
	1250373		P-UB-10	1-1/2	2-3/4	CTC-1856596	39.18
MODEL 910							
BUCKET							
	8J5391		P-UB-10	1-1/2	3-1/2	CTC-7X2752	80.70
LIFT							
	7J5893		P-UB-10	2	4	CTC-1328816	78.46
	7J5894		P-UB-10	2	4	CTC-1328816	78.46
STEERING							
	1U4666		P-UB-10	1-1/2	2-3/4	CTC-7X2736	106.91
	1U4666		P-UB-10	1-1/2	2-3/4	CTC-8T1402	41.92
	8J0070		P-UB-10	1-1/2	2-3/4	CTC-7X2749	49.96
	9T5153		P-UB-10	1-1/2	2-3/4	CTC-7X2736	106.91
	9T7209		P-UB-10	1-1/2	2-3/4	CTC-1361599	90.09
	9T7210		P-UB-10	1-1/2	2-3/4	CTC-1361599	90.09
STEERING LH							
	6E5973		P-UB-10	1-1/2	2-3/4	CTC-1361599	90.09
STEERING RH							
	6E5985		P-UB-10	1-1/2	2-3/4	CTC-1361599	90.09
TILT							
	1U3164		P-UB-10	1-3/4	3-1/4	CTC-7X2764	54.01
	1U3165		P-UB-10	1-3/4	3-1/4	CTC-1328770	102.07
	7J5885		P-UB-10	1-3/4	3	CTC-7X2791	74.94
	9J7905		P-UB-10	1-3/4	3	CTC-7X2791	74.94
TILT EXT'D DUMP							
	1U3164		P-UB-10	1-3/4	3-1/4	CTC-7X2764	54.01

CATERPILLAR®



REPLACEMENT KITS FOR CATERPILLAR® EQUIPMENT

Wheel Loaders							
APPLICATION	CYL #	Misc-Parts, Instructions, etc.	CODE	ROD	BORE	KIT #	List \$
MODEL 910							
TOOL BAR							
	4H6711		P-V-10	1-1/4	4	CTC-8T1480	69.97
MODEL 910E, 910F							
BUCKET							
	8J5391		P-UB-10	1-1/2	3-1/2	CTC-7X2752	80.70
STEERING							
	9T7209		P-UB-10	1-1/2	2-3/4	CTC-1361599	90.09
	9T7210		P-UB-10	1-1/2	2-3/4	CTC-1361599	90.09
STEERING LH							
	6E5900		P-UB-10	1-3/4	2-3/4	CTC-1539053	127.54
	6E5973		P-UB-10	1-1/2	2-3/4	CTC-1361599	90.09
STEERING RH							
	6E5985		P-UB-10	1-1/2	2-3/4	CTC-1361599	90.09
TILT							
	6E5966	Rod Bearing width- 0.98"	P-UB-10	2-1/2	4-3/4	CTC-1361131	121.12
MODEL 914							
M.P. BUCKET TILT							
	4T4666		P-UB-10	2-1/2	4	CTC-7X2665	141.19
MODEL 914G							
STEERING							
	9T8823		I-O-3	1	2	CTC-9T0418	70.20
MODEL 916							
BUCKET							
	3G7365		P-UB-10	1-1/2	3-1/2	CTC-7X2752	80.70
LIFT							
	4T8648		P-UB-10	2-1/4	4-1/4	CTC-7X2750	96.77
LIFT LH							
	3G6563		P-UB-10	2-1/4	4-1/4	CTC-7X2750	96.77
PIN PULLER							
	6E5393		I-O-3	1	2	CTC-9T0418	70.20
STEERING							
	1U3322		P-UB-10	1-1/2	3	CTC-7X2751	54.17
TILT							
	3G6571		P-UB-10	2-1/2	4-3/4	CTC-1328811	136.56
MODEL 918F							
LIFT							
	1342327		P-UB-10	2-1/4	4	CTC-1546526	127.50
	9T3937		P-UB-10	2-1/4	4	CTC-1546526	127.50
PIN PULLER							
	6E5393		I-O-3	1	2	CTC-9T0418	70.20
STEERING							
	9T2637		P-UB-10	1-1/2	2-3/4	CTC-1361599	90.09
TILT							
	1107845		P-UB-10	2-1/2	4-1/2	CTC-1113300	115.52
	1342671		P-UB-10	2-1/2	4-1/2	CTC-1113300	115.52
	6E4651		P-UB-10	2-1/2	4-1/2	CTC-1113300	115.52



REPLACEMENT KITS FOR CATERPILLAR® EQUIPMENT

Wheel Loaders							
APPLICATION	CYL #	Misc-Parts, Instructions, etc.	CODE	ROD	BORE	KIT #	List \$
MODEL 920							
BUCKET							
	7J6789		P-UB-10	2	4	CTC-7X2789	86.29
	8J5663		P-UB-10	2	4	CTC-7X2789	86.29
BUCKET LH							
	6J2806		P-UB-10	2	4	CTC-7X2789	86.29
BUCKET RH							
	6J2805		P-UB-10	2	4	CTC-7X2789	86.29
LIFT							
	3G5511		P-UB-10	2-1/4	4-1/4	CTC-7X2750	96.77
	3G5512		P-UB-10	2-1/4	4-1/4	CTC-7X2750	96.77
	6J8731		P-UB-10	2-1/4	4-1/4	CTC-7X2750	96.77
	6J8732		P-UB-10	2-1/4	4-1/4	CTC-7X2750	96.77
LIFT LH							
	7J9852		P-UB-10	2-1/4	4-1/4	CTC-7X2750	96.77
LIFT RH							
	7J9851		P-UB-10	2-1/4	4-1/4	CTC-7X2750	96.77
M.P. BUCKET LH							
	6J2806		P-UB-10	2	4	CTC-7X2789	86.29
M.P. BUCKET RH							
	6J2605		P-UB-10	2	4	CTC-7X2789	86.29
SIDE DUMP							
	8J5670		P-UB-10	2	4	CTC-7X2755	115.58
	8J5670		P-UB-10	2	4	CTC-7X7937	126.05
STEERING							
	6J5477		P-UB-10	1-1/2	3	CTC-7X2751	54.17
	7J9838		P-UB-10	1-1/2	3	CTC-1372530	76.40
	7J9838		P-UB-10	1-1/2	3	CTC-7X2751	54.17
TILT LH							
	3G5482		P-UB-10	2	4	CTC-1328816	78.46
	7J3052		P-UB-10	2	4	CTC-7X2789	86.29
	7J9676		P-UB-10	2	4	CTC-7X2789	86.29
TILT RH							
	3G5481		P-UB-10	2	4	CTC-1328816	78.46
	7J3051		P-UB-10	2	4	CTC-7X2789	86.29
	7J9675		P-UB-10	2	4	CTC-7X2789	86.29
MODEL 924							
M.P. BUCKET TILT							
	4T5545		P-UB-10	2-1/2	4-1/4	CTC-7X2663	41.78
MODEL 924F							
LIFT							
	1342327		P-UB-10	2-1/4	4	CTC-1546526	127.50
	9T3937		P-UB-10	2-1/4	4	CTC-1546526	127.50
STEERING							
	9T2637		P-UB-10	1-1/2	2-3/4	CTC-1361599	90.09

CATERPILLAR®



REPLACEMENT KITS FOR CATERPILLAR® EQUIPMENT

Wheel Loaders							
APPLICATION	CYL #	Misc-Parts, Instructions, etc.	CODE	ROD	BORE	KIT #	List \$
MODEL 924F							
TILT							
	1107845		P-UB-10	2-1/2	4-1/2	CTC-1113300	115.52
	1342671		P-UB-10	2-1/2	4-1/2	CTC-1113300	115.52
	6E4651		P-UB-10	2-1/2	4-1/2	CTC-1113300	115.52
MODEL 924G							
LIFT							
	1417483		P-UB-10	2-1/2	4	CTC-1542501	128.09
STEERING							
	1426251		P-UB-10	1-1/2	2-3/4	CTC-1361599	90.09
TILT							
	1525306		P-UB-10	2-1/2	4-3/4	CTC-1361131	121.12
MODEL 926							
BUCKET							
	4T9387		P-UB-10	2	4	CTC-1328816	78.46
LIFT							
	3G2991		P-UB-10	2-1/2	4-3/4	CTC-1328811	136.56
	3G2991		P-UB-10	2-1/2	4-3/4	CTC-7X2660	151.93
PIN PULLER							
	6E5393		I-O-3	1	2	CTC-9T0418	70.20
STEERING							
	3G3501		P-UB-10	1-1/2	3	CTC-7X2751	54.17
TILT							
	3G2798		P-UB-10	2-1/2	5-1/2	CTC-7X2671	125.31
	3G2798		P-UB-10	2-1/2	5-1/2	CTC-9X2047	91.52
MODEL 926E							
BUCKET							
	4T9387		P-UB-10	2	4	CTC-1328816	78.46
LIFT							
	3G2991		P-UB-10	2-1/2	4-3/4	CTC-1328811	136.56
	3G2991		P-UB-10	2-1/2	4-3/4	CTC-7X2660	151.93
STEERING							
	3G3501		P-UB-10	1-1/2	3	CTC-7X2751	54.17
	4T1574		P-UB-10	2	4	CTC-1328816	78.46
TILT							
	3G2798		P-UB-10	2-1/2	5-1/2	CTC-7X2671	125.31
	3G2798		P-UB-10	2-1/2	5-1/2	CTC-9X2047	91.52
MODEL 928F							
LIFT							
	1341383		P-UB-10	2-1/2	4-1/2	CTC-1113300	115.52
	6E1400		P-UB-10	2-1/2	4-1/2	CTC-1113300	115.52
PIN PULLER							
	6E5393		I-O-3	1	2	CTC-9T0418	70.20
STEERING							
	9T6646		P-UB-10	1-1/2	2-3/4	CTC-1361599	90.09
TILT							
	1341382	Rod Bearing width- 0.98"	P-UB-10	2-1/2	4-3/4	CTC-1361131	121.12
	9T6645	Rod Bearing width- 0.98"	P-UB-10	2-1/2	4-3/4	CTC-1361131	121.12



REPLACEMENT KITS FOR CATERPILLAR® EQUIPMENT

Wheel Loaders							
APPLICATION	CYL #	Misc-Parts, Instructions, etc.	CODE	ROD	BORE	KIT #	List \$
MODEL 928G							
COUPLER							
	2370946		P-UB-10	2-1/2	5	CTC-2138433	10.98
LIFT							
	1191060	Rod Bearing width- 0.98"	P-UB-10	2-1/2	4-3/4	CTC-1864382	80.26
STEERING LH							
	1250374		P-UB-10	1-1/2	2-3/4	CTC-1856596	39.18
STEERING RH							
	1250373		P-UB-10	1-1/2	2-3/4	CTC-1856596	39.18
TILT							
	1188105		P-UB-10	2-1/2	5	CTC-2275347	79.38
MODEL 930							
BUCKET							
	7J6789		P-UB-10	2	4	CTC-7X2789	86.29
	8J5663		P-UB-10	2	4	CTC-7X2789	86.29
BUCKET LH							
	6J2806		P-UB-10	2	4	CTC-7X2789	86.29
BUCKET RH							
	6J2805		P-UB-10	2	4	CTC-7X2789	86.29
LIFT							
	3G5471		P-UB-10	2-1/4	4-1/2	CTC-1326770	127.03
	4T0299		P-UB-10	2-1/4	4-1/2	CTC-7X2748	91.01
LIFT LH							
	7J9872		P-UB-10	2-1/4	4-1/2	CTC-7X2747	158.04
LIFT RH							
	7J9871		P-UB-10	2-1/4	4-1/2	CTC-7X2747	158.04
LOG FORK LH							
	8J5677		P-V-10	2	5	CTC-7X2763	114.58
LOG FORK RH							
	8J5676		P-V-10	2	5	CTC-7X2763	114.58
SIDE DUMP							
	8J5670		P-UB-10	2	4	CTC-7X2755	115.58
	8J5670		P-UB-10	2	4	CTC-7X7937	126.05
STEERING							
	7J9838		P-UB-10	1-1/2	3	CTC-1372530	76.40
	7J9838		P-UB-10	1-1/2	3	CTC-7X2751	54.17
TILT LH							
	7J9730		P-UB-10	2	4-1/4	CTC-7X2766	37.33
TILT RH							
	7J9729		P-UB-10	2	4-1/4	CTC-7X2766	37.33
MODEL 930R, 930T							
ARTICULATION							
	9T2447	930R only	P-UB-10	1-3/4	3	CTC-7X2825	42.17
LIFT LH							
	7J9872		P-UB-10	2-1/4	4-1/2	CTC-7X2747	158.04
LIFT RH							
	7J9871		P-UB-10	2-1/4	4-1/2	CTC-7X2747	158.04

CATERPILLAR®



REPLACEMENT KITS FOR CATERPILLAR® EQUIPMENT

Wheel Loaders							
APPLICATION	CYL #	Misc-Parts, Instructions, etc.	CODE	ROD	BORE	KIT #	List \$
MODEL 930R, 930T							
STEERING							
	7J9838		P-UB-10	1-1/2	3	CTC-1372530	76.40
	7J9838		P-UB-10	1-1/2	3	CTC-7X2751	54.17
TILT LH							
	7J9730		P-UB-10	2	4-1/4	CTC-7X2766	37.33
TILT RH							
	7J9729		P-UB-10	2	4-1/4	CTC-7X2766	37.33
MODEL 936							
LIFT							
	3G2991		P-UB-10	2-1/2	4-3/4	CTC-7X2660	151.93
	4T1674		P-UB-10	2-1/2	5-1/2	CTC-7X2672	75.10
	9T1196		P-UB-10	2-1/2	5-1/2	CTC-7X2672	75.10
PIN COUPLER							
	4T9981		I-O-3	1	2	CTC-9T0418	70.20
	6E5392		I-O-3	1	2	CTC-9T0418	70.20
	6E5393		I-O-3	1	2	CTC-9T0418	70.20
	9T8485		I-O-3	1	2	CTC-9T0418	70.20
STEERING							
	3G5110		P-UB-10	1-3/4	3-1/2	CTC-7X2784	47.66
TILT							
	3G5291		P-UB-10	2-3/4	6-1/2	CTC-7X2686	102.12
MODEL 936E							
LIFT							
	3G2991		P-UB-10	2-1/2	4-3/4	CTC-7X2660	151.93
	4T0263		P-UB-10	2-1/2	4-3/4	CTC-7X2660	151.93
	4T0263		P-UB-10	2-1/2	4-3/4	CTC-7X2673	150.91
	4T1674		P-UB-10	2-1/2	5-1/2	CTC-7X2672	75.10
	9T1196		P-UB-10	2-1/2	5-1/2	CTC-7X2672	75.10
M.P. BUCKET							
	4T9387		P-UB-10	2	4	CTC-7X2789	86.29
M.P. BUCKET TILT							
	4T5545		P-UB-10	2-1/2	4-1/4	CTC-7X2663	41.78
PIN COUPLER							
	4T9981		I-O-3	1	2	CTC-9T0418	70.20
	9T2352		I-O-3	1	2	CTC-9T0418	70.20
	9T8485		I-O-3	1	2	CTC-9T0418	70.20
STEERING							
	3G3501		P-UB-10	1-1/2	3	CTC-7X2751	54.17
	3G5110		P-UB-10	1-3/4	3-1/2	CTC-7X2784	47.66
TILT							
	3G5291		P-UB-10	2-3/4	6-1/2	CTC-7X2686	102.12
MODEL 936F							
LIFT							
	9T1196		P-UB-10	2-1/2	5-1/2	CTC-7X2672	75.10
PIN PULLER							
	6E5393		I-O-3	1	2	CTC-9T0418	70.20



REPLACEMENT KITS FOR CATERPILLAR® EQUIPMENT

Wheel Loaders							
APPLICATION	CYL #	Misc-Parts, Instructions, etc.	CODE	ROD	BORE	KIT #	List \$
MODEL 936F							
STEERING							
	3G5110		P-UB-10	1-3/4	3-1/2	CTC-7X2784	47.66
	6E2035		P-UB-10	1-3/4	3-1/2	CTC-7X2784	47.66
TILT							
	3G5291		P-UB-10	2-3/4	6-1/2	CTC-7X2686	102.12
MODEL 938F							
LIFT							
	1287678		P-UB-10	2-1/2	5	CTC-1361967	163.90
	9T7160	Rod Bearing width- 0.98"	P-UB-10	2-1/2	4-3/4	CTC-1361131	121.12
STEERING							
	1050094		P-UB-10	1-3/4	3	CTC-7X2825	42.17
TILT							
	1377855		P-UB-10	2-3/4	5-1/2	CTC-1358736	179.37
	9T7161		P-UB-10	2-3/4	5-1/2	CTC-1358736	179.37
MODEL 938G							
COUPLER							
	2080828		P-UB-10	2-1/2	5	CTC-2138433	10.98
	2370946		P-UB-10	2-1/2	5	CTC-2138433	10.98
LIFT							
	1KM1-1123; 2RM1-1123; 7SN1-384						
	9T7160	Head# 1206679	P-UB-10	2-1/2	4-3/4	CTC-1864382	80.26
	9T7160	Head# 9T3609	P-UB-10	2-1/2	4-3/4	CTC-9X2151	70.25
	1KM1124-; 2RM1124-; 7SN385-						
	1287678		P-UB-10	2-1/2	5	CTC-1361967	163.90
STEERING							
	1050094		P-UB-10	1-3/4	3	CTC-7X2825	42.17
	1393312		P-UB-10	1-3/4	3	CTC-7X2825	42.17
TILT							
	4YS1-						
	1377855		P-UB-10	2-3/4	5-1/2	CTC-1358736	179.37
	9T7161		P-UB-10	2-3/4	5-1/2	CTC-1358736	179.37
MODEL 944, 944A							
LOG FORK LH							
	8J5677		P-V-10	2	5	CTC-7X2763	114.58
LOG FORK RH							
	8J5676		P-V-10	2	5	CTC-7X2763	114.58
MODEL 950							
LIFT							
	7J9690		P-UB-10	2-1/2	5-1/2	CTC-9X2050	85.17
LIFT LH							
	1U1147		P-UB-10	3	6	CTC-7X2698	157.60
LIFT RH							
	1U1148		P-UB-10	3	6	CTC-7X2698	157.60
LOG FORK LH							
	8J5677		P-V-10	2	5	CTC-7X2763	114.58
LOG FORK RH							
	8J5676		P-V-10	2	5	CTC-7X2763	114.58

CATERPILLAR®



REPLACEMENT KITS FOR CATERPILLAR® EQUIPMENT

Wheel Loaders							
APPLICATION	CYL #	Misc-Parts, Instructions, etc.	CODE	ROD	BORE	KIT #	List \$
MODEL 950							
SIDE DUMP							
	8J5690		P-V-10	2	5	CTC-7X2763	114.58
STEERING							
	3G0892		P-UB-10	1-3/4	3-1/2	CTC-7X2762	84.64
	3G0892		P-UB-10	1-3/4	3-1/2	CTC-7X2784	47.66
	7J9685		P-UB-10	1-1/2	3-1/2	CTC-7X2812	88.00
TILT							
	3G8786		P-UB-10	3-1/4	7	CTC-7X2704	119.62
	7J9695		P-UB-10	2-1/2	5-1/2	CTC-9X2050	85.17
TILT LH							
	7J9696		P-UB-10	2-1/2	5-1/2	CTC-9X2050	85.17
TILT RH							
	7J9363		P-UB-10	2-1/2	6	CTC-1363121	139.16
TREE HARVESTER DELIMBER							
	8J3829		P-UB-10	2	4	CTC-7X2789	86.29
	9J2481		P-UB-10	1-3/4	3	CTC-7X2791	74.94
MODEL 950B, 950E, 950F							
LIFT							
	4T0263	950B & 950E only	P-UB-10	2-1/2	4-3/4	CTC-1328811	136.56
	4T0263		P-UB-10	2-1/2	4-3/4	CTC-7X2660	151.93
	4T0263		P-UB-10	2-1/2	4-3/4	CTC-7X2673	150.91
	7J9902	950F only	P-UB-10	2	4-1/4	CTC-7X2819	88.92
LIFT LH							
	1U1147		P-UB-10	3	6	CTC-7X2698	157.60
LIFT RH							
	1U1148		P-UB-10	3	6	CTC-7X2698	157.60
STEERING							
	3G0892		P-UB-10	1-3/4	3-1/2	CTC-7X2784	47.66
	6E3889		P-UB-10	1-3/4	3-1/2	CTC-7X2784	47.66
	6E4892		P-UB-10	1-3/4	3-1/2	CTC-7X2784	47.66
	6E5024	950B & 950F only	P-UB-10	2	4	CTC-1113302	100.62
TILT							
	3G8786		P-UB-10	3-1/4	7	CTC-1328518	193.93
MODEL 950G							
COUPLER							
	2080828		P-UB-10	2-1/2	5	CTC-2138433	10.98
	2370946		P-UB-10	2-1/2	5	CTC-2138433	10.98
LIFT							
	1188296		P-UB-10	3	6	CTC-7X2698	157.60
	1250024		P-UB-10	3	6	CTC-7X2698	157.60
STEERING							
	1188288	Head# 1537182	P-UB-10	1-3/4	3-1/2	CTC-2281795	83.02
	1630324	Head# 1630329	P-UB-10	1-3/4	3-1/2	CTC-2281795	83.02
	4BS1-413; 3JW1-684; 5FW1-784						
	1188288	Head# 9T7890	P-UB-10	1-3/4	3-1/2	CTC-7X2784	47.66



REPLACEMENT KITS FOR CATERPILLAR® EQUIPMENT

Wheel Loaders							
APPLICATION	CYL #	Misc-Parts, Instructions, etc.	CODE	ROD	BORE	KIT #	List \$
MODEL 950G							
TILT							
	1189001		P-UB-10	3-1/4	7	CTC-7X2710	219.31
	1518206		P-UB-10	3-1/4	8-1/2	CTC-1518206K	295.82
MODEL 950H							
COUPLER							
	2370946		P-UB-10	2-1/2	5	CTC-2138433	10.98
LIFT							
	2424271		P-UB-10	3-1/4	5-3/4	CTC-2424271K	214.34
	2424272		P-UB-10	3-1/4	5-3/4	CTC-2424272K	214.34
STEERING							
	1630324		P-UB-10	1-3/4	3-1/2	CTC-2281795	83.02
TILT							
	2424270		P-UB-10	3-1/4	6-1/4	CTC-2424270K	164.99
	2457487		P-UB-10	3-1/2	7-1/2	CTC-2457487K	206.64
	2457491		P-UB-10	3-1/4	6-1/4	CTC-2457491K	164.99
MODEL 960F							
LIFT							
	7J9902		P-UB-10	2	4-1/4	CTC-7X2819	88.92
LIFT LH							
	1U1147		P-UB-10	3	6	CTC-7X2698	157.60
LIFT RH							
	1U1148		P-UB-10	3	6	CTC-7X2698	157.60
STEERING							
	3G0892		P-UB-10	1-3/4	3-1/2	CTC-7X2784	47.66
	6E3889		P-UB-10	1-3/4	3-1/2	CTC-7X2784	47.66
	6E4892		P-UB-10	1-3/4	3-1/2	CTC-7X2784	47.66
TILT							
	3G8786		P-UB-10	3-1/4	7	CTC-1328518	193.93
MODEL 960G, 962G							
LIFT RH							
	1188296		P-UB-10	3	6	CTC-7X2698	157.60
	1250024		P-UB-10	3	6	CTC-7X2698	157.60
STEERING							
	1188288		P-UB-10	1-3/4	3-1/2	CTC-7X2784	47.66
TILT							
	1294447		P-UB-10	3-1/4	7	CTC-7X2710	219.31
MODEL 966							
LIFT							
	9J2434		P-UB-10	2-1/2	6-1/2	CTC-7X2666	143.68
STEERING							
	6E5024		P-UB-10	2	4	CTC-1113302	100.62
STEERING LH							
	7J9356		P-UB-10	2	4	CTC-7X2755	115.58
TILT							
	3G5497		P-UB-14	3-1/4	8-1/4	CTC-7X2703	199.38
TILT LH							
	7J9364		P-UB-10	2-1/2	6	CTC-7X2669	197.74

CATERPILLAR®



REPLACEMENT KITS FOR CATERPILLAR® EQUIPMENT

Wheel Loaders							
APPLICATION	CYL #	Misc-Parts, Instructions, etc.	CODE	ROD	BORE	KIT #	List \$
MODEL 966A							
LOG FORK LH							
	8J5677		P-V-10	2	5	CTC-7X2763	114.58
LOG FORK RH							
	8J5676		P-V-10	2	5	CTC-7X2763	114.58
SIDE DUMP							
	8J5733		P-V-10	2	5	CTC-7X2763	114.58
TILT LH							
	6J6874		P-UB-10	2-1/2	6	CTC-7X2669	197.74
	7J9364		P-UB-10	2-1/2	6	CTC-7X2669	197.74
	7J9364		P-UB-10	2-1/2	6	CTC-8T2066	89.45
TILT RH							
	6J6873		P-UB-10	2-1/2	6	CTC-7X2669	197.74
	7J9363		P-UB-10	2-1/2	6	CTC-7X2669	197.74
	7J9363		P-UB-10	2-1/2	6	CTC-8T2066	89.45
MODEL 966B							
LIFT							
	9J2434		P-UB-10	2-1/2	6-1/2	CTC-7X2666	143.68
LIFT RH							
	4J7859		P-UB-10	2	4	CTC-7X2755	115.58
LOG FORK							
	8J5755		P-UB-10	2-1/4	5	CTC-7X2729	137.33
LOG FORK LH							
	8J5677		P-V-10	2	5	CTC-7X2763	114.58
LOG FORK RH							
	8J5676		P-V-10	2	5	CTC-7X2763	114.58
SIDE DUMP							
	8J5733		P-V-10	2	5	CTC-7X2763	114.58
SPECIAL APPLICATION							
	4J9996		P-UB-10	2-1/2	7-1/4	CTC-7X2661	153.05
STEERING LH							
	7J9356		P-UB-10	2	4	CTC-7X2755	115.58
STEERING RH							
	7J9355		P-UB-10	2	4	CTC-7X2755	115.58
TILT LH							
	6J6874		P-UB-10	2-1/2	6	CTC-7X2669	197.74
	7J9364		P-UB-10	2-1/2	6	CTC-7X2669	197.74
	7J9364		P-UB-10	2-1/2	6	CTC-8T2066	89.45
TILT RH							
	6J6873		P-UB-10	2-1/2	6	CTC-7X2669	197.74
	7J9363		P-UB-10	2-1/2	6	CTC-7X2669	197.74
	7J9363		P-UB-10	2-1/2	6	CTC-8T2066	89.45
MODEL 966C							
BUCKET TILT LH							
	5J2464		P-UB-10	2-1/2	6	CTC-8T2066	89.45
BUCKET TILT RH							
	5J2463		P-UB-10	2-1/2	6	CTC-8T2066	89.45



REPLACEMENT KITS FOR CATERPILLAR® EQUIPMENT

Wheel Loaders							
APPLICATION	CYL #	Misc-Parts, Instructions, etc.	CODE	ROD	BORE	KIT #	List \$
MODEL 966C							
LIFT							
	3G5471		P-UB-10	2-1/4	4-1/2	CTC-1326770	127.03
	9J2434		P-UB-10	2-1/2	6-1/2	CTC-7X2666	143.68
LOG FORK							
	8J5755		P-UB-10	2-1/4	5	CTC-7X2729	137.33
LOG FORK LH							
	4K0502		P-V-10	2	5	CTC-7X2763	114.58
	8J5677		P-V-10	2	5	CTC-7X2763	114.58
LOG FORK RH							
	8J5676		P-V-10	2	5	CTC-7X2763	114.58
SIDE DUMP							
	8J5733		P-V-10	2	5	CTC-7X2763	114.58
SPECIAL APPLICATION							
	4J9996		P-UB-10	2-1/2	7-1/4	CTC-7X2661	153.05
STEERING LH							
	7J9356		P-UB-10	2	4	CTC-7X2755	115.58
STEERING RH							
	7J9355		P-UB-10	2	4	CTC-7X2755	115.58
TILT LH							
	6J6874		P-UB-10	2-1/2	6	CTC-7X2669	197.74
	7J9364		P-UB-10	2-1/2	6	CTC-7X2669	197.74
	7J9364		P-UB-10	2-1/2	6	CTC-8T2066	89.45
TILT RH							
	6J6873		P-UB-10	2-1/2	6	CTC-7X2669	197.74
	6J6873		P-UB-10	2-1/2	6	CTC-8T2066	89.45
	6J6875		P-UB-10	2-1/2	6	CTC-8T2066	89.45
	6J6876		P-UB-10	2-1/2	6	CTC-8T2066	89.45
	7J9363		P-UB-10	2-1/2	6	CTC-1363121	139.16
	7J9363		P-UB-10	2-1/2	6	CTC-7X2669	197.74
MODEL 966D							
LIFT LH							
	3G5495		P-UB-10	3-1/4	7	CTC-7X2710	219.31
LIFT RH							
	3G5496		P-UB-10	3-1/4	7	CTC-7X2710	219.31
STEERING							
	4T1574		P-UB-10	2	4	CTC-1328816	78.46
	6E4892		P-UB-10	1-3/4	3-1/2	CTC-7X2784	47.66
	6E5024		P-UB-10	2	4	CTC-1113302	100.62
	9J7061		P-UB-10	2	4	CTC-7X2789	86.29
TILT							
	3G5497		P-UB-14	3-1/4	8-1/4	CTC-7X2703	199.38
MODEL 966E, 966F							
LIFT LH							
	3G5495		P-UB-10	3-1/4	7	CTC-7X2710	219.31
LIFT RH							
	3G5496		P-UB-10	3-1/4	7	CTC-7X2710	219.31

CATERPILLAR®



REPLACEMENT KITS FOR CATERPILLAR® EQUIPMENT

Wheel Loaders							
APPLICATION	CYL #	Misc-Parts, Instructions, etc.	CODE	ROD	BORE	KIT #	List \$
MODEL 966E, 966F							
STEERING							
	4T1574		P-UB-10	2	4	CTC-1328816	78.46
	6E5024		P-UB-10	2	4	CTC-1113302	100.62
	9J7061	966E only	P-UB-10	2	4	CTC-7X2789	86.29
TILT							
	3G5497		P-UB-14	3-1/4	8-1/4	CTC-7X2703	199.38
MODEL 966G							
LIFT LH							
	1332964		P-UB-10	3-1/4	7	CTC-7X2710	219.31
LIFT RH							
	1332963		P-UB-10	3-1/4	7	CTC-7X2710	219.31
STEERING							
	1331747		P-UB-10	2	3-1/2	CTC-7X2783	87.11
TILT							
	1332962		P-UB-10	3-1/4	9-1/4	CTC-1332962K	242.17
	1449005		P-UB-10	3-1/4	8-1/4	CTC-2281780	185.86
	1713953		P-UB-10	3-1/4	8-1/4	CTC-2281780	185.86
	1882445		P-UB-10	3-1/2	9-1/4	CTC-2282533	266.39
MODEL 966H							
LIFT							
	2424274		P-UB-10	3-1/2	6-1/4	CTC-2959888	174.53
	2424275		P-UB-10	3-1/2	6-1/4	CTC-2959888	174.53
STEERING							
	1331747		P-UB-10	2	3-1/2	CTC-7X2783	87.11
TILT							
	2424273		P-UB-10	3-1/4	170 mm	CTC-2424273K	171.85
	2448777		P-UB-10	3-3/4	7-3/4	CTC-2448777K	213.53
	2457484		P-UB-10	3-1/4	170 mm	CTC-2457484K	171.85
MODEL 966R							
LIFT							
	9J2434		P-UB-10	2-1/2	6-1/2	CTC-7X2666	143.68
STEERING LH							
	7J9356		P-UB-10	2	4	CTC-7X2755	115.58
STEERING RH							
	7J9355		P-UB-10	2	4	CTC-7X2755	115.58
TILT LH							
	7J9364		P-UB-10	2-1/2	6	CTC-1363121	139.16
	7J9364		P-UB-10	2-1/2	6	CTC-7X2669	197.74
	7J9364		P-UB-10	2-1/2	6	CTC-8T2066	89.45
TILT RH							
	7J9363		P-UB-10	2-1/2	6	CTC-1363121	139.16
	7J9363		P-UB-10	2-1/2	6	CTC-7X2669	197.74
	7J9363		P-UB-10	2-1/2	6	CTC-8T2066	89.45
MODEL 970F							
LIFT LH							
	6E5879		P-UB-10	3-1/4	7	CTC-7X2710	219.31

CATERPILLAR®



REPLACEMENT KITS FOR CATERPILLAR® EQUIPMENT

Wheel Loaders							
APPLICATION	CYL #	Misc-Parts, Instructions, etc.	CODE	ROD	BORE	KIT #	List \$
MODEL 970F							
LIFT RH	6E5878		P-UB-10	3-1/4	7	CTC-7X2710	219.31
STEERING	4T1574		P-UB-10	2	4	CTC-1328816	78.46
	6E5024		P-UB-10	2	4	CTC-1113302	100.62
TILT	3G5497		P-UB-14	3-1/4	8-1/4	CTC-7X2703	199.38
MODEL 972G							
LIFT LH	1332964		P-UB-10	3-1/4	7	CTC-7X2710	219.31
LIFT RH	1332963		P-UB-10	3-1/4	7	CTC-7X2710	219.31
STEERING	1331747		P-UB-10	2	3-1/2	CTC-7X2783	87.11
MODEL 980, 980B							
LIFT	7J9818	980B only	P-V-10	2-1/2	6-1/2	CTC-7X2678	92.56
	7J9818		P-UB-10	3	7-1/4	CTC-7X2699	182.12
LOG FORK	8J5767		P-UB-10	2-1/4	5	CTC-7X2729	137.33
STEERING LH	7J9786		P-UB-10	2-1/4	4-1/2	CTC-7X2747	158.04
STEERING RH	7J9785		P-UB-10	2-1/4	4-1/2	CTC-7X2747	158.04
TILT LH	7J9742		P-UB-10	2-1/2	5-1/2	CTC-9X2050	85.17
TILT RH	7J9741		P-UB-10	2-1/2	5-1/2	CTC-9X2050	85.17
MODEL 980C							
LIFT	9J5559		P-UB-10	3-1/2	7-1/2	CTC-7X2730	135.37
	9J8002		P-UB-10	2-3/4	5-1/2	CTC-7X2684	129.90
LIFT-DEEPER DIG	1U3527		P-UB-10	3-1/2	7-1/2	CTC-7X2730	135.37
LIFT-HIGH	4T6791		P-UB-10	3	6-1/4	CTC-7X2701	95.33
	4T7949		P-UB-10	3	6-1/4	CTC-7X2701	95.33
LOGGER TILT	3G5069		P-UB-10	2-3/4	7	CTC-7X2691	123.99
	3G5070		P-UB-10	2-3/4	7	CTC-7X2691	123.99
STEERING	6E6653		P-UB-10	2-1/4	4-1/2	CTC-1354392	118.74
STEERING LH	9J6536		P-UB-10	2-1/4	4-1/2	CTC-7X2747	158.04
STEERING RH	9J5869		P-UB-10	2-1/4	4-1/2	CTC-7X2747	158.04

CATERPILLAR®



REPLACEMENT KITS FOR CATERPILLAR® EQUIPMENT

Wheel Loaders							
APPLICATION	CYL #	Misc-Parts, Instructions, etc.	CODE	ROD	BORE	KIT #	List \$
MODEL 980C							
TILT							
	1U0418		P-UB-10	3	5-1/2	CTC-7X2813	192.04
	9T2418		P-UB-10	3	6-1/4	CTC-7X2701	95.33
	9T2419		P-UB-10	3	6-1/4	CTC-7X2701	95.33
TILT LH							
	3G1306		P-UB-10	2-3/4	6-1/4	CTC-7X2688	125.16
	3G1306		P-UB-10	2-3/4	6-1/4	CTC-7X2688	125.16
	3G5070		P-UB-10	2-3/4	7	CTC-7X2691	123.99
	4T6791		P-UB-10	3	6-1/4	CTC-7X2701	95.33
	9T2419		P-UB-10	3	6-1/4	CTC-1328491	220.35
TILT RH							
	3G1305		P-UB-10	2-3/4	6-1/4	CTC-7X2688	125.16
	3G5069		P-UB-10	2-3/4	7	CTC-7X2691	123.99
	4T7949		P-UB-10	3	6-1/4	CTC-7X2701	95.33
	6E4866		P-UB-10	2-3/4	6-1/4	CTC-7X2688	125.16
	9T2418		P-UB-10	3	6-1/4	CTC-1328491	220.35
MODEL 980F							
LIFT							
	1U3527		P-UB-10	3-1/2	7-1/2	CTC-7X2730	135.37
STEERING							
	6E6653		P-UB-10	2-1/4	4-1/2	CTC-1354392	118.74
STEERING LH							
	9J6536		P-UB-10	2-1/4	4-1/2	CTC-7X2747	158.04
STEERING RH							
	9J5869		P-UB-10	2-1/4	4-1/2	CTC-7X2747	158.04
TILT LH							
	3G1306		P-UB-10	2-3/4	6-1/4	CTC-7X2688	125.16
	3G5070		P-UB-10	2-3/4	7	CTC-7X2691	123.99
	4T6791		P-UB-10	3	6-1/4	CTC-7X2701	95.33
	9T2419		P-UB-10	3	6-1/4	CTC-1328491	220.35
TILT RH							
	3G1305		P-UB-10	2-3/4	6-1/4	CTC-7X2688	125.16
	3G5069		P-UB-10	2-3/4	7	CTC-7X2691	123.99
	4T7949		P-UB-10	3	6-1/4	CTC-7X2701	95.33
	6E4866		P-UB-10	2-3/4	6-1/4	CTC-7X2688	125.16
	9T2418		P-UB-10	3	6-1/4	CTC-1328491	220.35
MODEL 980G							
LIFT							
	1118181		P-UB-10	3-1/2	7-3/4	CTC-2281775	134.94
STEERING							
	1151371		P-UB-10	2-1/4	4	CTC-1546526	127.50
TILT							
	1463032		P-UB-10	3	7	CTC-1605796	256.45

CATERPILLAR®



REPLACEMENT KITS FOR CATERPILLAR® EQUIPMENT

Wheel Loaders							
APPLICATION	CYL #	Misc-Parts, Instructions, etc.	CODE	ROD	BORE	KIT #	List \$
MODEL 980G							
TILT LH							
	1125004		P-UB-10	2-3/4	6-1/4	CTC-7X2688	125.16
	1240617		P-UB-10	3	7	CTC-1605796	256.45
	1246227		P-UB-10	3	6-1/4	CTC-1917694	183.93
	1463035		P-UB-10	3	7	CTC-1605796	256.45
TILT RH							
	1125003		P-UB-10	2-3/4	6-1/4	CTC-7X2688	125.16
	1240616		P-UB-10	3	7	CTC-1605796	256.45
	1246228		P-UB-10	3	6-1/4	CTC-1917694	183.93
MODEL 980H							
LIFT							
	1118181		P-UB-10	3-1/2	7-3/4	CTC-2281775	134.94
STEERING							
	1151371		P-UB-10	2-1/4	4	CTC-1546526	127.50
TILT LH							
	1125004		P-UB-10	2-3/4	6-1/4	CTC-7X2688	125.16
	1240617		P-UB-10	3	7	CTC-1605796	256.45
	1246227		P-UB-10	3	6-1/4	CTC-1917694	183.93
TILT RH							
	1125003		P-UB-10	2-3/4	6-1/4	CTC-7X2688	125.16
	1240616		P-UB-10	3	7	CTC-1605796	256.45
	1246228		P-UB-10	3	6-1/4	CTC-1917694	183.93
MODEL 988							
LIFT							
	4J7377		P-UB-10	3-1/4	8-1/4	CTC-7X2715	224.12
	7J9744		P-UB-10	3-1/4	8-1/4	CTC-7X2717	171.10
	9J4893		P-UB-10	3-1/4	8-1/4	CTC-7X2717	171.10
STEERING							
	6J7590		P-UB-10	2-1/4	5	CTC-7X2729	137.33
	7J9718		P-UB-10	2-1/4	5	CTC-7X2729	137.33
	7J9984		P-UB-10	2-1/4	5	CTC-7X2729	137.33
TILT							
	9J3632		P-UB-10	3-1/4	7-3/4	CTC-7X2706	225.60
TILT LH							
	4J5744		P-UB-10	2-1/2	6-1/2	CTC-8T1376	67.29
	7J9762		P-UB-10	2-3/4	6-1/2	CTC-7X2689	136.20
TILT RH							
	4J5743		P-UB-10	2-1/2	6-1/2	CTC-8T1376	67.29
	7J9761		P-UB-10	2-3/4	6-1/2	CTC-7X2689	136.20
UNSPECIFIED APPLICATION							
	7K9401		P-UB-10	2-1/4	5	CTC-7X2729	137.33
MODEL 988B							
BUCKET LIFT							
	9T8257		P-UB-10	4	8-1/2	CTC-7X2742	182.87

CATERPILLAR®



REPLACEMENT KITS FOR CATERPILLAR® EQUIPMENT

Wheel Loaders							
APPLICATION	CYL #	Misc-Parts, Instructions, etc.	CODE	ROD	BORE	KIT #	List \$
MODEL 988B							
LIFT							
	1U4679		P-UB-10	4	8-1/2	CTC-7X2734	256.24
	4T7585		P-UB-10	4	8-1/2	CTC-7X2742	182.87
	8J5779		P-UB-10	4	8-1/2	CTC-7X2734	256.24
	9T8257		P-UB-10	4	8-1/2	CTC-7X2742	182.87
LOGGER TILT							
	3G2976		P-UB-10	3-1/2	8-1/2	CTC-7X2719	158.89
STEERING							
	5R4547		P-UB-10	2-1/4	5	CTC-9X6392	135.36
	9J8165		P-UB-10	2-1/4	5	CTC-9X6392	135.36
TILT							
	3G2976		P-UB-10	3-1/2	8-1/2	CTC-7X2719	158.89
	4T6792		P-UB-10	3-1/2	7-3/4	CTC-1570284	272.78
	9J3632		P-UB-10	3-1/4	7-3/4	CTC-7X2706	225.60
MODEL 988F							
LIFT							
	9T8257		P-UB-10	4	8-1/2	CTC-7X2742	182.87
STEERING							
	9J8165		P-UB-10	2-1/4	5	CTC-9X6392	135.36
TILT							
	3G2976		P-UB-10	3-1/2	8-1/2	CTC-7X2719	158.89
	4T6792		P-UB-10	3-1/2	7-3/4	CTC-1570284	272.78
	9J3632		P-UB-10	3-1/4	7-3/4	CTC-7X2706	225.60
MODEL 988G							
LIFT							
	1521644		P-UB-10	4-1/2	220 mm	CTC-2295546	312.70
LIFT LH							
	1686943	Logging Arrangement	P-UB-10	5	9-1/4	CTC-1686943K	285.25
LIFT RH							
	1686942	Logging Arrangement	P-UB-10	5	9-1/4	CTC-1686942K	285.25
STEERING LH							
	1338173		P-UB-10	2-1/2	4	CTC-1542501	128.09
	2594733		P-UB-10	2-1/2	4	CTC-2594733K	72.04
STEERING RH							
	1353288		P-UB-10	2-1/2	4	CTC-1542501	128.09
	2594737		P-UB-10	2-1/2	4	CTC-2594737K	72.04
TILT							
	1521644	High Lift Arrangement	P-UB-10	4-1/2	220 mm	CTC-2295546	312.70
	1686944		P-UB-10	4-1/2	9-1/4	CTC-1686944K	322.25
	2311955		P-UB-10	4-1/2	220 mm	CTC-2295546	312.70
MODEL 990							
TILT							
	1459897		P-UB-10	5-3/4	11-1/2	CTC-1354382	381.76
	9T9570		P-UB-10	5-3/4	11-1/2	CTC-1354382	381.76
TILT LH							
	6E4835		P-UB-10	3-1/2	8-1/4	CTC-7X2721	246.28



REPLACEMENT KITS FOR CATERPILLAR® EQUIPMENT

Wheel Loaders							
APPLICATION	CYL #	Misc-Parts, Instructions, etc.	CODE	ROD	BORE	KIT #	List \$
MODEL 992, 992B							
LIFT							
	7J8969		P-UB-10	6-1/2	10-1/2	CTC-8T1456	311.67
LIFT LH							
	7J8970		P-UB-10	6-1/2	10-1/2	CTC-8T1456	311.67
	8J5978		P-UB-10	6-1/2	10-1/2	CTC-8T1456	311.67
LIFT RH							
	8J5977		P-UB-10	6-1/2	10-1/2	CTC-8T1456	311.67
STEERING							
	7J9800		P-UB-10	2-1/2	5-1/2	CTC-8T1374	79.00
	8J6339		P-UB-10	2-1/2	5-1/2	CTC-7X2653	137.42
	8J6339		P-UB-10	2-1/2	5-1/2	CTC-8T1374	79.00
	9K5707		P-UB-10	2-1/2	5-1/2	CTC-8T1374	79.00
TILT LH							
	8J6338		P-UB-10	3-1/2	8-1/2	CTC-7X2719	158.89
TILT RH							
	8J6337		P-UB-10	3-1/2	8-1/2	CTC-7X2719	158.89
MODEL 992C							
LIFT							
	1U1771		P-UB-10	7	11-1/2	CTC-7X2809	350.62
	9J2994		P-UB-10	7	11-1/2	CTC-7X2809	350.62
LIFT HIGH							
	1U1771		P-UB-10	7	11-1/2	CTC-7X2809	350.62
	9J2994		P-UB-10	7	11-1/2	CTC-7X2809	350.62
STEERING							
	9J5419		P-UB-10	3-1/4	7	CTC-7X2710	219.31
TILT HIGH							
	1U1766		P-UB-10	4	10	CTC-7X2811	232.23
	1U1767		P-UB-10	4	10	CTC-7X2811	232.23
TILT LH							
	3G4599		P-UB-14	4	10	CTC-7X2810	195.25
TILT RH							
	3G4598		P-UB-14	4	10	CTC-7X2810	195.25
MODEL 992D							
LIFT							
	1028731		P-UB-10	7	11-1/2	CTC-7X2809	350.62
	1U1771		P-UB-10	7	11-1/2	CTC-7X2809	350.62
	9J2994		P-UB-10	7	11-1/2	CTC-7X2809	350.62
STEERING							
	9J5419		P-UB-10	3-1/4	7	CTC-7X2710	219.31
TILT LH							
	1026248		P-UB-14	4	10	CTC-7X2810	195.25
	1U1767		P-UB-10	4	10	CTC-7X2811	232.23
	3G4599		P-UB-14	4	10	CTC-7X2810	195.25
TILT RH							
	1026247		P-UB-14	4	10	CTC-7X2810	195.25
	1U1766		P-UB-10	4	10	CTC-7X2811	232.23
	3G4598		P-UB-14	4	10	CTC-7X2810	195.25

CATERPILLAR®



REPLACEMENT KITS FOR CATERPILLAR® EQUIPMENT

Wheel Loaders							
APPLICATION	CYL #	Misc-Parts, Instructions, etc.	CODE	ROD	BORE	KIT #	List \$
MODEL G910							
LIFT							
	7J5893		P-UB-10	2	4	CTC-1328816	78.46
	7J5894		P-UB-10	2	4	CTC-1328816	78.46
STEERING							
	1U4666		P-UB-10	1-1/2	2-3/4	CTC-7X2736	106.91
	1U4666		P-UB-10	1-1/2	2-3/4	CTC-8T1402	41.92
TILT							
	1U3165		P-UB-10	1-3/4	3-1/4	CTC-1328770	102.07
	1U4666		P-UB-10	1-1/2	2-3/4	CTC-7X2749	49.96
	7J5885		P-UB-10	1-3/4	3	CTC-7X2791	74.94
	7J5893		P-UB-10	2	4	CTC-7X2789	86.29
	7J5894		P-UB-10	2	4	CTC-7X2789	86.29
MODEL G916							
LIFT							
	4T8648		P-UB-10	2-1/4	4-1/4	CTC-7X2750	96.77
PIN PULLER							
	6E5393		I-O-3	1	2	CTC-9T0418	70.20
STEERING							
	1U3322		P-UB-10	1-1/2	3	CTC-7X2751	54.17
TILT							
	3G6571		P-UB-10	2-1/2	4-3/4	CTC-1328811	136.56
MODEL G926							
LIFT							
	3G2991		P-UB-10	2-1/2	4-3/4	CTC-1328811	136.56
	3G2991		P-UB-10	2-1/2	4-3/4	CTC-7X2660	151.93
PIN PULLER							
	6E5393		I-O-3	1	2	CTC-9T0418	70.20
STEERING							
	3G3501		P-UB-10	1-1/2	3	CTC-7X2751	54.17
TILT							
	3G2798		P-UB-10	2-1/2	5-1/2	CTC-8T3576	76.44
	3G2798		P-UB-10	2-1/2	5-1/2	CTC-9X2047	91.52
MODEL G936							
LIFT							
	4T1674		P-UB-10	2-1/2	5-1/2	CTC-7X2672	75.10
	9T1196		P-UB-10	2-1/2	5-1/2	CTC-7X2672	75.10
PIN PULLER							
	6E5393		I-O-3	1	2	CTC-9T0418	70.20
STEERING							
	3G5110		P-UB-10	1-3/4	3-1/2	CTC-7X2784	47.66
TILT							
	3G5291		P-UB-10	2-3/4	6-1/2	CTC-7X2686	102.12
Wheel Tractors							
APPLICATION	CYL #	Misc-Parts, Instructions, etc.	CODE	ROD	BORE	KIT #	List \$
MODEL 814							
BLADE TIP							
	1U4744		P-UB-10	2	4	CTC-7X2755	115.58



REPLACEMENT KITS FOR CATERPILLAR® EQUIPMENT

Wheel Tractors							
APPLICATION	CYL #	Misc-Parts, Instructions, etc.	CODE	ROD	BORE	KIT #	List \$
MODEL 814							
DOZER							
	7J7028		P-UB-10	2-1/2	4-3/4	CTC-7X2773	150.91
LIFT							
	1U2088		P-UB-10	2-1/2	4-3/4	CTC-7X2660	151.93
LIFT RH							
	4J7859		P-UB-10	2	4	CTC-7X2755	115.58
STEERING							
	4T1574		P-UB-10	2	4	CTC-1328816	78.46
STEERING LH							
	7J9356		P-UB-10	2	4	CTC-7X2755	115.58
STEERING RH							
	7J9355		P-UB-10	2	4	CTC-7X2755	115.58
TILT							
	7J7295		P-UB-10	2	4-1/2	CTC-7X2768	75.01
MODEL 814B							
BLADE TIP							
	1U4744		P-UB-10	2	4	CTC-7X2755	115.58
DOZER							
	1U2088		P-UB-10	2-1/2	4-3/4	CTC-1328811	136.56
DOZER LIFT							
	1U2088		P-UB-10	2-1/2	4-3/4	CTC-7X2660	151.93
	7J7028		P-UB-10	2-1/2	4-3/4	CTC-7X2660	151.93
STEERING							
	4T1574		P-UB-10	2	4	CTC-1328816	78.46
	6E5024		P-UB-10	2	4	CTC-1113302	100.62
TILT							
	7J7295		P-UB-10	2	4-1/2	CTC-7X2768	75.01
MODEL 814F							
DOZER							
	1U2088		P-UB-10	2-1/2	4-3/4	CTC-1328811	136.56
STEERING							
	4T1574		P-UB-10	2	4	CTC-1328816	78.46
	6E5024		P-UB-10	2	4	CTC-1113302	100.62
MODEL 814S							
BLADE TIP							
	1U4744		P-UB-10	2	4	CTC-7X2755	115.58
TILT							
	7J7295		P-UB-10	2	4-1/2	CTC-7X2768	75.01
MODEL 824							
BLADE TIP							
	4J5632		P-V-10	2-1/2	6-1/2	CTC-7X2678	92.56
	4J6006	App requires 2 kits.	P-UB-10	2-1/2	6	CTC-7X2656	136.40
	4J6006	App requires 2 kits.	P-UB-10	2-1/2	6	CTC-7X2692	138.95
BLADE TIP LH							
	4J4498		P-UB-10	2-1/2	6	CTC-7X2656	136.40

CATERPILLAR®



REPLACEMENT KITS FOR CATERPILLAR® EQUIPMENT

Wheel Tractors							
APPLICATION	CYL #	Misc-Parts, Instructions, etc.	CODE	ROD	BORE	KIT #	List \$
MODEL 824							
LIFT							
	3J9307		P-V-10	2-1/2	6-1/2	CTC-7X2676	92.56
	4J6005		P-V-10	2-1/2	6-1/2	CTC-7X2676	92.56
	4J7621		P-V-10	2-1/2	6-1/2	CTC-7X2676	92.56
	4J9233		P-V-10	2	4-1/2	CTC-7X2770	82.84
	6J1269		P-V-10	2-1/2	6-1/2	CTC-7X2676	92.56
	6J1272		P-V-10	2-1/2	6-1/2	CTC-7X2676	92.56
	6J1273		P-V-10	2-1/2	6-1/2	CTC-7X2676	92.56
	9J7111		P-UB-10	2-1/2	5-1/2	CTC-7X2653	137.42
STEERING							
	7J9984		P-UB-10	2-1/4	5	CTC-7X2729	137.33
STEERING LH							
	9J7087		P-UB-10	2-1/4	5	CTC-7X2729	137.33
STEERING RH							
	9J7086		P-UB-10	2-1/4	5	CTC-7X2729	137.33
TILT RH							
	4J4497		P-V-10	2-1/2	6-1/2	CTC-7X2678	92.56
MODEL 824B							
BLADE LH							
	4J4498		P-UB-10	2-1/2	6	CTC-7X2656	136.40
BLADE TIP							
	4J6006	App requires 2 kits.	P-UB-10	2-1/2	6	CTC-7X2656	136.40
BLADE TIP LH							
	4J4498		P-UB-10	2-1/2	6	CTC-7X2656	136.40
LIFT							
	3J9307		P-V-10	2-1/2	6-1/2	CTC-7X2676	92.56
	4J6005		P-V-10	2-1/2	6-1/2	CTC-7X2676	92.56
	4J7621		P-V-10	2-1/2	6-1/2	CTC-7X2676	92.56
	4J9233		P-V-10	2	4-1/2	CTC-7X2770	82.84
	6J1269		P-V-10	2-1/2	6-1/2	CTC-7X2676	92.56
	6J1272		P-V-10	2-1/2	6-1/2	CTC-7X2676	92.56
	6J1273		P-V-10	2-1/2	6-1/2	CTC-7X2676	92.56
	9J7111		P-UB-10	2-1/2	5-1/2	CTC-7X2653	137.42
STEERING							
	6J7590		P-UB-10	2-1/4	5	CTC-7X2729	137.33
	7J9718		P-UB-10	2-1/4	5	CTC-7X2729	137.33
	7J9984		P-UB-10	2-1/4	5	CTC-7X2729	137.33
STEERING LH							
	9J7087		P-UB-10	2-1/4	5	CTC-7X2729	137.33
STEERING RH							
	9J7086		P-UB-10	2-1/4	5	CTC-7X2729	137.33
TILT RH							
	4J4497		P-V-10	2-1/2	6-1/2	CTC-7X2678	92.56
MODEL 824C							
BLADE LH							
	4J4498		P-UB-10	2-1/2	6	CTC-7X2656	136.40

CATERPILLAR®



REPLACEMENT KITS FOR CATERPILLAR® EQUIPMENT

Wheel Tractors							
APPLICATION	CYL #	Misc-Parts, Instructions, etc.	CODE	ROD	BORE	KIT #	List \$
MODEL 824C							
BLADE RH							
	4J4497		P-V-10	2-1/2	6-1/2	CTC-7X2678	92.56
BLADE TIP							
	4J4497		P-V-10	2-1/2	6-1/2	CTC-7X2678	92.56
	4J5632		P-V-10	2-1/2	6-1/2	CTC-7X2678	92.56
	4J6006	App requires 2 kits.	P-UB-10	2-1/2	6	CTC-7X2656	136.40
BLADE TIP LH							
	4J4498		P-UB-10	2-1/2	6	CTC-7X2656	136.40
LIFT							
	4J6005		P-V-10	2-1/2	6-1/2	CTC-7X2676	92.56
	6J1269		P-V-10	2-1/2	6-1/2	CTC-7X2676	92.56
	6J1272		P-V-10	2-1/2	6-1/2	CTC-7X2676	92.56
	6J1273		P-V-10	2-1/2	6-1/2	CTC-7X2676	92.56
	9J7111		P-UB-10	2-1/2	5-1/2	CTC-7X2653	137.42
LIFT LH							
	4J4498		P-UB-10	2-1/2	6	CTC-7X2656	136.40
STEERING LH							
	9J7087		P-UB-10	2-1/4	5	CTC-9X6392	135.36
STEERING RH							
	9J7086		P-UB-10	2-1/4	5	CTC-9X6392	135.36
MODEL 824S, 834S, 834U							
LIFT LH							
	4J4498		P-UB-10	2-1/2	6	CTC-7X2656	136.40
TILT RH							
	4J4497		P-V-10	2-1/2	6-1/2	CTC-7X2678	92.56
MODEL 830M							
DOZER LIFT							
	3R4109		P-UB-10	2-1/2	4-3/4	CTC-7X2660	151.93
LIFT							
	3J6439		P-UB-10	2-1/2	6	CTC-7X2679	116.87
RIPPER LIFT							
	3R6724		P-UB-10	2-1/2	6	CTC-7X2679	116.87
STEERING							
	5R0062		P-UB-10	2-1/4	5	CTC-7X2729	137.33
	7J9984		P-UB-10	2-1/4	5	CTC-7X2729	137.33
MODEL 834							
BLADE LH							
	4J4498		P-UB-10	2-1/2	6	CTC-7X2656	136.40
BLADE TIP							
	4J5632		P-V-10	2-1/2	6-1/2	CTC-7X2678	92.56
	4J6006	App requires 2 kits.	P-UB-10	2-1/2	6	CTC-7X2656	136.40
LIFT							
	4J6005		P-V-10	2-1/2	6-1/2	CTC-7X2676	92.56
	4J7621		P-V-10	2-1/2	6-1/2	CTC-7X2676	92.56
	4J9233		P-V-10	2	4-1/2	CTC-7X2770	82.84
	6J1269		P-V-10	2-1/2	6-1/2	CTC-7X2676	92.56
	6J1272		P-V-10	2-1/2	6-1/2	CTC-7X2676	92.56

CATERPILLAR®



REPLACEMENT KITS FOR CATERPILLAR® EQUIPMENT

Wheel Tractors							
APPLICATION	CYL #	Misc-Parts, Instructions, etc.	CODE	ROD	BORE	KIT #	List \$
MODEL 834							
STEERING							
	7J9984		P-UB-10	2-1/4	5	CTC-7X2729	137.33
	9J8165		P-UB-10	2-1/4	5	CTC-9X6392	135.36
TILT RH							
	4J4497		P-V-10	2-1/2	6-1/2	CTC-7X2678	92.56
MODEL 834B							
BLADE LH							
	4J4498		P-UB-10	2-1/2	6	CTC-7X2656	136.40
BLADE TIP							
	4J5632		P-V-10	2-1/2	6-1/2	CTC-7X2678	92.56
LIFT							
	4J7621		P-V-10	2-1/2	6-1/2	CTC-7X2676	92.56
	6J1272		P-V-10	2-1/2	6-1/2	CTC-7X2676	92.56
LIFT LH							
	4J4498		P-UB-10	2-1/2	6	CTC-7X2656	136.40
STEERING							
	9J8165		P-UB-10	2-1/4	5	CTC-9X6392	135.36
TILT RH							
	4J4497		P-V-10	2-1/2	6-1/2	CTC-7X2678	92.56
TIP							
	4J6006	App requires 2 kits.	P-UB-10	2-1/2	6	CTC-7X2656	136.40
MODEL 834C							
BLADE TIP							
	4J5632		P-V-10	2-1/2	6-1/2	CTC-7X2678	92.56
	4J6006	App requires 2 kits.	P-UB-10	2-1/2	6	CTC-7X2656	136.40

CATERPILLAR®

REPLACEMENT KITS FOR CATERPILLAR® EQUIPMENT

IMPORTANT – PLEASE READ

If a kit part number is unknown, the machine model number, serial number, and cylinder application will help identify the repair kit you need.

Example: Model Number **D5**
 Serial Number **63J806**
 Cylinder Application **Dozer Lift**

If none of the above information is known, size and description of the parts needed will almost always be sufficient.

NOTE: Caterpillar® kit numbers are used as a reference only. We do not imply that these kits are original REPLACEMENT KITS.

Kit Number	Code (Pg. xiv)	Rod X Bore Size	List Price	Kit Number	Code (Pg. xiv)	Rod X Bore Size	List Price
CTC-FIG0401	TRACK ADJUSTER KIT		\$ 79.31	CTC-1113301	P-UB-10	1-7/8 X 3	\$ 110.82
CTC-FIG0402	TRACK ADJUSTER KIT		93.45	CTC-1113302	P-UB-10	2 X 4	100.62
CTC-FIG0405	TRACK ADJUSTER KIT		83.86	CTC-1125343	I-SP-10, 3	8-3/4, 12-1/2 X 11, 13-3/4	729.65
CTC-FIG1401	TRACK ADJUSTER KIT		86.03	CTC-1126550	P-UB-10	3 X 6-1/2	149.91
CTC-FIG1402	TRACK ADJUSTER KIT		102.01	CTC-1131073	I,P-U-3	12 X 15-1/8	1651.11
CTC-FIG1405	TRACK ADJUSTER KIT		51.10	CTC-1132693	I-U-3	1-1/4 X 2-1/2	14.14
CTC-FIG2400	TRACK ADJUSTER KIT		64.99	CTC-1137463	I, P-U-3	9 X 10-3/4	1593.80
CTC-FIG3400	TRACK ADJUSTER KIT		50.60	CTC-1137472	I,P-U-3	13-1/2 X 16-1/8	1631.50
CTC-FIG3401	TRACK ADJUSTER KIT		47.23	CTC-1137475	P-UB-3	7 X 8	386.82
CTC-FIG3404	TRACK ADJUSTER KIT		33.91	CTC-1137476	I,P-U-3	11 X 13-1/8	1357.38
CTC-FIG4400	TRACK ADJUSTER KIT		40.63	CTC-1137478	P-UB-3	7 X 8	554.50
CTC-FIG4405	TRACK ADJUSTER KIT		18.92	CTC-1137480	I,P-U-3	12-1/2 X 14-1/4	767.53
CTC-0860174	P-UB-14	75 x 100 mm	228.63	CTC-1137482	I-UB-3	9 X 10-1/2	302.00
CTC-0875387	P-UB-10	100 X 140 mm	289.01	CTC-1143616		O-Ring Kit	5.19
CTC-0875394	P-UB-10	85 X 120 mm	218.89	CTC-1148290	P-UB-10	80 X 120 mm	171.65
CTC-0875407	P-UB-10	130 X 180 mm	336.78	CTC-1148526	P-UB-10	75 X 110 mm	202.84
CTC-0876654	P-UB-10	110 X 160 mm	271.50	CTC-1163529	P-UB-10	150 X 220 mm	493.49
CTC-0901523	MULTI STAGE	2.50, 3.25, 4.00	107.33	CTC-1163612	P-UB-10	105 X 150 mm	255.25
CTC-0919842	P-U-14	45 X 90 mm	67.55	CTC-1163649	P-UB-10	110 X 170 mm	318.56
CTC-0967625	P-UB-10	65 x 100 mm	285.19	CTC-1169123K	P-UB-10	105 X 150 mm	159.26
CTC-0967786	P-UB-10	75 x 110 mm	298.73	CTC-1180672	I-U-10	6 X 8-1/4	553.86
CTC-0995401	P-UB-14	70 X 100 mm	196.39	CTC-1183946	P-UB-10	110 X 160 mm	308.49
CTC-1002931	P-UB-10	3-1/4 X 5-1/2	335.33	CTC-1184024	P-UB-10	100 X 140 mm	275.32
CTC-1002932	P-UB-10	3-1/4 X 5-1/2	335.74	CTC-1184131	P-UB-10	85 X 120 mm	211.36
CTC-1002934	P-UB-10	4-1/4 X 6-1/2	339.95	CTC-1184175	P-UB-10	90 X 130 mm	249.77
CTC-1002935	P-UB-10	4-1/4 X 6-1/2	346.05	CTC-1186023	P-UB-10	85 X 120 mm	225.29
CTC-1002939	P-UB-10	3-3/4 X 6	414.40	CTC-1195435	P-UB-10	75 X 110 mm	249.91
CTC-1014201	P-UB-10	2-1/2 X 4-3/4	113.34	CTC-1195446	P-UB-10	80 X 120 mm	227.99
CTC-1016061	I-U-10	30 X 63 mm	106.56	CTC-1195457	P-UB-10	65 X 100 mm	181.46
CTC-1017554	P-UB-10	5-1/2 X 10-1/2	301.78	CTC-1234121K	P-UB-10	2 X 4	64.77
CTC-1038333	P-UB-14	60 X 90 mm	209.64	CTC-1247005	P-UB-10	85 X 160 mm	170.72
CTC-1040763	P-U-1	70 mm Rod Kit	46.42	CTC-1247008	P-UB-10	85 X 120 mm	133.00
CTC-1041023	P-U-1	75 mm Rod Kit	43.86	CTC-1247009	P-UB-10	80 X 110 mm	187.92
CTC-1045008	I-U-10	4 X 4-1/2	235.48	CTC-1261887	P-UB-10	90 X 130 mm	361.78
CTC-1052585	P-UB-10	90 X 130 mm	409.47	CTC-1261947	P-UB-10	85 X 120 mm	292.79
CTC-1052601	P-UB-10	85 X 130 mm	366.59	CTC-1261979	P-UB-10	130 X 190 mm	248.96
CTC-1057253	P-UB-14	55 X 80 mm	156.25	CTC-1270630	P-UB-10	100 X 140 mm	287.74
CTC-1057255	P-UB-14	75 X 110 mm	230.17	CTC-1270631	P-UB-10	100 X 140 mm	289.68
CTC-1057359	P-UB-10	80 X 100 mm	207.37	CTC-1270795	P-UB-10	2-1/2 X 5	100.24
CTC-1057379	P-UB-10	85 X 120 mm	219.24	CTC-1279809	P-UB-10	3 X 6-1/2	195.81
CTC-1057397	P-UB-10	70 X 100 mm	171.51	CTC-1281673	P-UB-10	3 x 5-1/2	193.33
CTC-1057480	P-UB-14	55 X 100 mm	178.70	CTC-1289277	P-UB-10	105 X 150 mm	311.24
CTC-1113300	P-UB-10	2-1/2 X 4-1/2	115.52	CTC-1289278	P-UB-10	110 X 170 mm	336.06

CATERPILLAR®



REPLACEMENT KITS FOR CATERPILLAR® EQUIPMENT

NOTE: Caterpillar® kit numbers are used as a reference only. We do not imply that these kits are original REPLACEMENT KITS.

Kit Number	Code (Pg. xiv)	Rod X Bore Size	List Price	Kit Number	Code (Pg. xiv)	Rod X Bore Size	List Price
CTC-1289280	P-UB-10	110 X 160 mm	\$ 325.95	CTC-1358695	P-UB-10	2-1/2 X 4-3/4	\$ 80.54
CTC-1296156	P-UB-10	100 X 170 mm	163.16	CTC-1358736	P-UB-10	2-3/4 X 5-1/2	179.37
CTC-1304012	P-UB-10	2-1/2 X 5	161.86	CTC-1361131	P-UB-10	2-1/2 x 4-3/4	121.12
CTC-1305923	P-UB-10	2-1/8 X 4	134.10	CTC-1361599	P-UB-10	1-1/2 X 2-3/4	90.09
CTC-1309483	P-UB-10	3-1/2 x 7-1/4	264.19	CTC-1361897	P-UB-10	2-1/4 X 3-3/4	134.65
CTC-1315106	P-UB-10	2-1/2 X 5	142.87	CTC-1361908	P-UB-10	2-5/8 X 5-1/4	149.58
CTC-1315118	P-UB-10	2-1/2 X 5	150.48	CTC-1361967	P-UB-10	2-1/2 X 5	163.90
CTC-1315164	P-UB-10	2-1/2 X 6	172.08	CTC-1361990	P-UB-10	2-3/4 X 3-3/4	147.09
CTC-1315423	P-UB-10	3 X 4	180.05	CTC-1363084	P-UB-10	3 x 6	119.36
CTC-1316108	P-UB-10	1-3/4 X 4	91.89	CTC-1363121	P-UB-10	2-1/2 X 6	139.16
CTC-1316109	P-UB-10	3 X 4-3/4	95.22	CTC-1363741	P-UB-10	3 X 6-1/2	133.19
CTC-1318700	P-UB-10	2-1/2 X 3-3/4	127.66	CTC-1365158	P-UB-10	3-1/2 X 6-1/4	174.96
CTC-1318733	P-UB-10	3 X 6-1/2	174.35	CTC-1368341	P-UB-10	2-1/2 X 6-1/2	137.86
CTC-1318740	P-UB-10	3 X 6-1/2	146.59	CTC-1368797	P-UB-10	3-1/4 X 6-1/2	187.36
CTC-1318748	P-UB-10	2-1/2 X 4	130.23	CTC-1370264	P-UB-10	2-1/2 X 6-1/2	148.50
CTC-1318778	P-UB-10	2-1/4 x 4-3/4	118.51	CTC-1371384	P-UB-10	3-1/4 X 9-1/4	194.92
CTC-1324905	P-UB-10	3-1/2 X 8-1/4	177.60	CTC-1371946	P-UB-10	4-3/4 X 7	309.67
CTC-1324922	P-UB-10	4 X 9-1/4	270.04	CTC-1371974	P-UB-10	3-1/2 X 8-1/4	215.86
CTC-1324932	P-UB-10	4 x 10-1/2	305.69	CTC-1372530	P-UB-10	1-1/2 X 3	76.40
CTC-1324937	P-UB-10	3 X 6	113.25	CTC-1373661	P-UB-10	100 X 140 mm	126.16
CTC-1324987	P-UB-10	3-1/4 X 7-1/4	191.32	CTC-1373763	P-UB-10	85 X 120 mm	312.80
CTC-1326121	P-UB-10	2-3/4 x 5-1/4	177.27	CTC-1373764	P-UB-10	100 X 140 mm	272.99
CTC-1326127	P-UB-10	3 X 7-1/4	175.93	CTC-1373765	P-UB-10	90 X 130 mm	402.63
CTC-1326148	P-UB-10	2-3/4 X 4-1/4	145.10	CTC-1373766	P-UB-10	100 X 140 mm	262.06
CTC-1326184	P-UB-10	3 X 7-1/4	191.08	CTC-1373767	P-UB-10	105 X 150 mm	354.28
CTC-1326770	P-UB-10	2-1/4 X 4-1/2	127.03	CTC-1373768	P-UB-10	90 X 130 mm	372.60
CTC-1326783	P-UB-10	4 X 7	219.74	CTC-1378662	P-UB-10	2 X 4-1/4	114.49
CTC-1327058	P-UB-10	1-1/2 X 3-1/2	87.86	CTC-1417975	P-UB-4	3-1/2 X 4-1/2	135.26
CTC-1327131	P-UB-10	2-3/4 X 5-1/2	169.48	CTC-1433201K	P-UB-10	100 X 170 mm	203.34
CTC-1328491	P-UB-10	3 X 6-1/4	220.35	CTC-1438153	P-UB-10	65X100 mm	223.70
CTC-1328518	P-UB-10	3-1/4 X 7	193.93	CTC-1469860	P-UB-10	2-1/2 X 4-1/2	136.41
CTC-1328770	P-UB-10	1-3/4 X 3-1/4	102.07	CTC-1475781	P-UB-10	85 x 125 mm	243.29
CTC-1328783	P-V-10	2 X 4-1/2	63.16	CTC-1518206K	P-UB-10	3-1/4 X 8-1/2	295.82
CTC-1328811	P-UB-10	2-1/2 X 4-3/4	136.56	CTC-1531282	I-SP-10, 3	7-3/4, 11-1/2 X 10, 12-1/2	579.18
CTC-1328816	P-UB-10	2 X 4	78.46	CTC-1533724	P-UB-10	2-1/2 X 4	180.99
CTC-1331747K	P-UB-10	2 X 3-1/2	67.17	CTC-1539053	P-UB-10	1-3/4 X 2-3/4	127.54
CTC-1332962K	P-UB-10	3-1/4 X 9-1/4	242.17	CTC-1539054	P-UB-10	1-3/4 X 2-1/2	122.06
CTC-1334802	P-UB-10	3-1/4 X 7	209.55	CTC-1540728	P-UB-10	85 X 120 mm	412.57
CTC-1336646	P-UB-10	80 X 110 mm	209.60	CTC-1540744	P-UB-10	85 X 120 mm	396.77
CTC-1336691	P-UB-10	70 X 100 mm	181.96	CTC-1540748	P-UB-10	90 x 130 mm	243.70
CTC-1336823	P-UB-10	100 X 140 mm	271.64	CTC-1540757	P-UB-10	90 X 130mm	379.28
CTC-1344485K	P-UB-10	55 X 100 mm	99.80	CTC-1540761	P-UB-10	100 X 140 mm	323.35
CTC-1349838K	P-UB-10	35 X 70 mm	132.40	CTC-1540766	P-UB-10	105 X 150 mm	331.97
CTC-1350532K	P-UB-10	50 X 85 mm	181.87	CTC-1540773	P-UB-10	90 X 130mm	379.03
CTC-1352167	P-UB-10	2-3/4 x 6	178.13	CTC-1542501	P-UB-10	2-1/2 X 4	128.09
CTC-1353223	P-UB-10	2-1/2 X 4	135.69	CTC-1542502	P-UB-10	2-1/2 X 7-1/4	163.63
CTC-1353253	P-UB-10	2-1/2 X 4	133.34	CTC-1542503	P-UB-10	3 X 4-3/4	105.86
CTC-1353802	P-UB-10	3 x 4-1/2	139.46	CTC-1546526	P-UB-10	2-1/4 X 4	127.50
CTC-1354382	P-UB-10	5-3/4 X 11-1/2	381.76	CTC-1560626	P-UB-10	140 x 200 mm	552.29
CTC-1354392	P-UB-10	2-1/4 x 4-1/2	118.74	CTC-1560627	P-UB-10	150 X 220 mm	493.49
CTC-1354539	P-UB-14	3-1/4 X 5-1/2	104.12	CTC-1565209	I,P-U-3	11 X 12-1/2	487.56
CTC-1358166	P-UB-10	2-1/4 X 3-1/2	145.07	CTC-1570284	P-UB-10	3-1/2 x 7-3/4	272.78

NORTH AMERICA
PHONE 1-800-777-5617
FAX 1-800-759-6391

SALES OFFICE HOURS
8 A.M. TO 8 P.M. EASTERN TIME
www.HerculesUS.com

WORLDWIDE
PHONE 1-727-796-1300
FAX 1-727-797-8849

REPLACEMENT KITS FOR CATERPILLAR® EQUIPMENT

NOTE: Caterpillar® kit numbers are used as a reference only. We do not imply that these kits are original REPLACEMENT KITS.

Kit Number	Code (Pg. xiv)	Rod X Bore Size	List Price
CTC-1570287	P-UB-10	2-3/4 X 5-1/2	\$ 125.73
CTC-1570288	P-UB-10	3 X 4-3/4	145.81
CTC-1586389	P-UB-10	75 X 110 mm	177.38
CTC-1589092	P-UB-10	85 X 120 mm	154.26
CTC-1589093	P-UB-10	100 X 140 mm	103.63
CTC-1597775	P-UB-10	85 X 120 mm	150.30
CTC-1605796	P-UB-10	3 x 7	256.45
CTC-1649430K	P-UB-10	1-1/4 X 2-1/2	41.62
CTC-1659416	P-UB-10	130 X 190 mm	249.44
CTC-1659418	P-UB-10	85 X 120 mm	109.81
CTC-1659420	P-UB-10	80 X110 mm	117.63
CTC-1680758	P-UB-10	105 X 150 mm	295.22
CTC-1680759	P-UB-10	110 X 170 mm	338.96
CTC-1680760	P-UB-10	110 X 160 mm	328.81
CTC-1686942K	P-UB-10	5 X 9-1/4	285.25
CTC-1686943K	P-UB-10	5 X 9-1/4	285.25
CTC-1686944K	P-UB-10	4-1/2 X 9-1/4	322.25
CTC-1697826	P-U-15	75 X 110 mm	112.58
CTC-1697835	P-UB-10	80 X 120 mm	182.89
CTC-1697837	P-UB-10	75 x 110 mm	219.71
CTC-1697838	P-UB-10	80 x 120 mm	229.50
CTC-1697839	P-UB-10	65 x 100 mm	185.28
CTC-1697843	P-UB-10	70 X 130 mm	248.60
CTC-1697895	P-UB-14	55 X 90 mm	173.94
CTC-1700221	P-UB-10	2-1/2 X 4-3/4	119.82
CTC-1709937	P-UB-10	75 X 110 mm	131.78
CTC-1709941	P-UB-10	65 X 100 mm	109.74
CTC-1709999	P-UB-10	80 X 120 mm	162.88
CTC-1702156	I-UB-10	125 X 220 mm	735.85
CTC-1709827	P-UB-10	70 X 100 mm	92.77
CTC-1721689	I-UB-5	2 X 4-1/2	154.71
CTC-1721690	P-UB-10	2 X 4-1/2	41.12
CTC-1721691	P-UB-10	3-1/2 X 5-1/2	145.40
CTC-1756855K	P-UB-10	100 X 140 mm	150.28
CTC-1764914	P-UB-10	90 X 130 mm	120.02
CTC-1764934	P-UB-10	85 X 120 mm	196.72
CTC-1764935	P-UB-10	65 X 100 mm	187.18
CTC-1764999	P-UB-10	95 X 130 mm	203.29
CTC-1791715	I-U-3	3/4 X 1-1/2	12.78
CTC-1791749	I-O-3	3/4 X 1-1/2	4.55
CTC-1799625	P-UB-10	80 X 110 mm	212.96
CTC-1799772	P-U-10	90 X 130 mm	174.88
CTC-1799634	P-UB-10	85 X 120 mm	109.81
CTC-1799638	P-UB-10	70 X 100 mm	82.66
CTC-1799764K	P-UB-10	90 X 130 mm	105.79
CTC-1799785K	P-UB-10	105 X 150 mm	148.46
CTC-1799791K	P-UB-10	105 X 150 mm	287.56
CTC-1847660K	P-UB-10	85 X 140 mm	114.60
CTC-1850196	P-UB-10	90 X 130 mm	139.69
CTC-1850223	P-UB-10	85 X 125 mm	140.17
CTC-1855574	P-UB-10	95 X 160	159.92
CTC-1856583	P-UB-10	1-1/2 X 3	38.75

Kit Number	Code (Pg. xiv)	Rod X Bore Size	List Price
CTC-1856586	P-UB-10	1-1/2 X 2-3/4	\$ 29.06
CTC-1856587	P-UB-10	1-1/2 X 3	51.38
CTC-1856588	P-UB-10	1-1/2 X 3-1/2	54.74
CTC-1856596	P-UB-10	1-1/2 X 2-3/4	39.18
CTC-1856601	P-UB-10	1-1/2 X 2-1/2	43.80
CTC-1857018	P-UB-10	1-3/4 X 3-1/2	50.63
CTC-1857024	P-UB-10	1-3/4 X 2-3/4	46.55
CTC-1857025	P-UB-10	1-3/4 X 3	39.25
CTC-1857667	P-UB-10	2 X 3	71.63
CTC-1857669	P-UB-10	2 X 4-1/4	40.89
CTC-1857672	P-UB-10	2 X 3-1/2	59.69
CTC-1857674	P-UB-10	2 X 3-1/2	97.71
CTC-1857681	P-U-10	2 X 3-1/2	91.10
CTC-1857686	I-UB-10	2 X 4	71.65
CTC-1857687	N-UB-10	2 X 4	126.05
CTC-1857688	P-UB-10	2 X 4	58.90
CTC-1857699	I-UB-10	2 X 4-1/2	182.06
CTC-1857700	P-UB-10	2 X 4-1/2	82.16
CTC-1859502	P-UB-10	2-1/4 X 5	50.41
CTC-1859503	P-UB-10	2-1/4 X 3-1/2	116.35
CTC-1859504	P-UB-10	2-3/4 X 4-1/2	46.37
CTC-1859507	P-UB-10	2-1/4 X 4-1/4	93.98
CTC-1859517	P-UB-10	2-1/4 X 4-1/4	112.92
CTC-1859523	P-UB-10	2-1/4 X 4-1/2	44.71
CTC-1859527	P-UB-10	2-1/4 X 4	96.96
CTC-1864327	I-UB-10	2-1/2 X 3-1/2	58.91
CTC-1864332	P-UB-10	2-1/2 X 5	61.88
CTC-1864333	P-UB-10	2-1/2 X 4	51.25
CTC-1864336	P-UB-10	2-1/2 X 4-1/4	76.66
CTC-1864337	P-UB-10	2-1/2 X 4-1/4	42.30
CTC-1864338	P-UB-10	2-1/2 X 4	69.04
CTC-1864340	P-UB-10	2-1/2 X 6	88.06
CTC-1864349	P-U-10	2-1/2 X 6	85.34
CTC-1864357	P-UB-10	2-1/2 X 6-1/2	79.37
CTC-1864368	P-UB-10	2-1/2 X 6	63.51
CTC-1864373	P-UB-10	2-1/2 X 4-1/4	86.80
CTC-1864358	P-U-10	2-1/2 X 5-1/2	46.26
CTC-1864381	P-UB-10	2-1/2 X 4-3/4	131.42
CTC-1864382	P-UB-10	2-1/2 X 4-3/4	80.26
CTC-1864391	P-UB-10	2-1/2 X 4-1/2	67.65
CTC-1884219	P-UB-10	105 X 150 mm	137.21
CTC-1884457	P-UB-10	95 X 160 mm	185.51
CTC-1890263	P-UB-10	3-1/2 X 5-1/2	207.99
CTC-1890268	P-U-10	2-3/4 X 5	64.94
CTC-1890271	P-UB-10	2-3/8 X 3-3/4	44.73
CTC-1890281	P-UB-10	100 X 140 mm	340.64
CTC-1890282	P-UB-10	100 x 140 mm	245.38
CTC-1895377	P-UB-10	3-1/4 x 9-1/4	203.95
CTC-1895381	P-UB-10	3-1/4 X 5-1/2	122.08
CTC-1905432	P-UB-10	3-1/4 X 9-1/4	293.07
CTC-1912322	P-UB-10	3 X 5-1/2	101.54
CTC-1912430	P-U-10	3 X 6-1/2	110.05

CATERPILLAR®



REPLACEMENT KITS FOR CATERPILLAR® EQUIPMENT

NOTE: Caterpillar® kit numbers are used as a reference only. We do not imply that these kits are original REPLACEMENT KITS.

Kit Number	Code (Pg. xiv)	Rod X Bore Size	List Price	Kit Number	Code (Pg. xiv)	Rod X Bore Size	List Price
CTC-1912432	P-UB-10	3 X 6-1/2	\$ 89.31	CTC-2044910K	P-UB-10	90 X 130	\$ 116.32
CTC-1913171	P-UB-10	110 X 170	203.34	CTC-2044912K	P-UB-10	100 X 140	149.07
CTC-1915027	I-U-10	2-3/4 X 4	99.32	CTC-2044914K	P-UB-10	90 X 130	96.03
CTC-1915028	P-UB-10	3 X 4-3/4	95.22	CTC-2095874	P-UB-10	100 X 140 mm	214.88
CTC-1915030	P-UB-10	3 X 4-3/4	137.05	CTC-2119614	P-UB-10	90 X 130	133.60
CTC-1915031	P-UB-10	3 X 6	113.25	CTC-2138433	I-U-10	2-1/2 X 5	10.98
CTC-1915551K	P-UB-10	115 X 170	238.22	CTC-2144502	P-UB-10	100 X 140	130.38
CTC-1915619	P-UB-10	105 X 150 mm	137.21	CTC-2149170	P-UB-10	3-1/4 X 8-1/4	143.52
CTC-1915649	P-UB-10	115 X 170	268.77	CTC-2159985	P-UB-10	100 X 140 mm	103.63
CTC-1917694	P-UB-10	3 X 6-1/4	183.93	CTC-2159986	P-UB-10	90 X 130	105.79
CTC-1919204	P-UB-10	3 X 6	137.71	CTC-2159988	P-UB-10	110 X 160	169.01
CTC-1921409	P-UB-10	3 X 7-1/4	141.39	CTC-2159989	P-UB-10	110 X 160 mm	215.45
CTC-1923010	P-UB-10	3 X 5-1/4	112.96	CTC-2159990	P-UB-10	110 X 170	187.21
CTC-1933088	P-UB-10	1-7/8 X 3-1/4	74.10	CTC-2159995	P-UB-10	140 X 200	320.83
CTC-1933098	P-UB-10	4 X 10	195.25	CTC-2235944	I-UB-10	2-3/4 X 3-3/4	67.02
CTC-1933092	P-UB-10	2-3/4 X 6-1/2	69.70	CTC-2254625	P-UB-10	110 X 160	228.21
CTC-1933117	P-UB-10	2-3/4 X 4-1/2	94.37	CTC-2254646	P-UB-10	130 X 190	272.05
CTC-1935427	P-UB-10	2-3/4 X 6	79.51	CTC-2275347	P-UB-10	2-1/2 X 5	79.38
CTC-1935431	P-UB-10	2-1/8 X 4	74.10	CTC-2275350	P-UB-10	1-3/4 X 3	26.28
CTC-1935433	P-UB-10	3-1/2 X 8-1/4	177.60	CTC-2281775	P-UB-10	3-1/2 X 7-3/4	134.94
CTC-1937635	P-UB-10	3-1/2 X 6-1/4	203.09	CTC-2281776	P-UB-10	3 X 5-1/4	91.70
CTC-1937639	P-UB-10	2-3/4 X 5-1/2	101.60	CTC-2281778	P-UB-10	2 X 3-1/2	65.73
CTC-1939261	P-UB-10	2-3/4 X 6	202.22	CTC-2281779	P-UB-10	3-1/4 X 7	127.04
CTC-1939269	P-UB-10	2-3/4 X 5-1/2	103.36	CTC-2281780	P-UB-10	3-1/4 X 8-1/4	185.86
CTC-1939271	P-UB-10	2-3/4 X 9-1/4	197.98	CTC-2281793	P-UB-10	3 X 6	122.51
CTC-1942756	P-UB-10	3-1/2 X 4-1/2	279.63	CTC-2281795	P-UB-10	1-3/4 X 3-1/2	83.02
CTC-1944396	P-UB-10	4 X 4-1/2	206.38	CTC-2282533	P-UB-10	3-1/2 X 9-1/4	266.39
CTC-1944397	P-UB-10	2-3/4 X 4	139.89	CTC-2285273	P-UB-10	2-1/2 X 5-1/2	70.45
CTC-1944398	P-UB-10	4 X 4-1/2	194.17	CTC-2292626	P-UB-10	2-1/2 X 4	83.23
CTC-1944399	P-UB-10	3-1/2 X 4-1/2	206.79	CTC-2292758	P-UB-10	3 X 4-1/2	67.96
CTC-1945586	P-UB-10	3-1/2 X 10-1/2	307.29	CTC-2295507	P-UB-10	4 X 7	205.02
CTC-1945588	P-UB-10	7 X 11	718.84	CTC-2295546	P-UB-10	4-1/2 X 220 mm	312.70
CTC-1945600	P-UB-10	2-3/8 X 4	47.73	CTC-2304001	P-UB-10	110 X 180	222.22
CTC-1945603	I-UB-10	2-3/4 X 3-3/4	73.98	CTC-2310898	P-UB-10	2-1/2 X 4-1/2	63.79
CTC-1945606	P-UB-10	4-1/4 X 7-3/4	215.65	CTC-2316844	P-UB-10	115 X 170	268.77
CTC-1948235	P-UB-10	110 X 160	200.19	CTC-2316845	P-UB-10	115 X 170	274.41
CTC-1948396	P-UB-10	110 X 160	179.15	CTC-2330763	P-UB-10	100 X 170	190.11
CTC-1980648K	I-U-10	45 X 60	39.60	CTC-2330764	P-UB-10	95 X 160 mm	171.60
CTC-1997416	P-UB-10	105 X 150 mm	174.43	CTC-2339204	P-UB-10	1-1/2 X 2-3/4	52.92
CTC-1997417	P-UB-10	110 X 170	188.76	CTC-2339205	P-UB-10	2 X 4	50.72
CTC-2003315	P-UB-10	105 X 150 mm	137.21	CTC-2341948	P-UB-10	2-1/2 X 4-3/4	76.65
CTC-2003498	P-UB-10	130 X 190	264.67	CTC-2341949	P-UB-10	2-1/2 X 4	47.00
CTC-2003499	P-UB-10	130 X 180	256.73	CTC-2342591	P-UB-10	2-1/4 X 4	54.57
CTC-2042721	P-UB-10	110 X 160	196.44	CTC-2342595	P-UB-10	1-3/4 X 2-3/4	127.54
CTC-2043616	P-UB-10	100 X 140	130.38	CTC-2344442	P-UB-10	110 X 170	202.04
CTC-2043625	P-UB-10	85 X 120 mm	201.50	CTC-2344488	P-UB-10	95 X 135	198.56
CTC-2043626	P-UB-10	100 X 140 mm	259.02	CTC-2344566	P-UB-10	100 X 140	123.68
CTC-2043627	P-UB-10	85 X 120	118.30	CTC-2344576	P-UB-10	105 X 150	284.06
CTC-2043628	P-UB-10	85 X 125	127.30	CTC-2344587	P-UB-10	95 X 135	113.49
CTC-2043629	P-UB-10	90 X 130 mm	229.55	CTC-2344667	P-UB-10	150 X 220 mm	559.51
CTC-2043630	P-UB-10	90 X 130 mm	214.11	CTC-2344674	P-UB-10	110 X 160 mm	186.72
CTC-2043692	P-UB-10	85 X 120	125.36	CTC-2350351	P-UB-10	1-3/4 X 2-3/4	122.66

NORTH AMERICA
PHONE 1-800-777-5617
FAX 1-800-759-6391

SALES OFFICE HOURS
8 A.M. TO 8 P.M. EASTERN TIME
www.HerculesUS.com

WORLDWIDE
PHONE 1-727-796-1300
FAX 1-727-797-8849

REPLACEMENT KITS FOR CATERPILLAR® EQUIPMENT

NOTE: Caterpillar® kit numbers are used as a reference only. We do not imply that these kits are original REPLACEMENT KITS.

Kit Number	Code (Pg. xiv)	Rod X Bore Size	List Price
CTC-2350352	P-UB-10	1-3/4 X 2-3/4	\$ 85.15
CTC-2350354	P-UB-10	1-1/2 X 3	29.07
CTC-2350973	P-UB-10	2-3/8 X 4-3/4	130.07
CTC-2355802	P-UB-10	2-3/4 X 6-1/2	61.44
CTC-2366368	P-UB-10	85 X 120	86.07
CTC-2366389	P-U-10	85 X 120	86.07
CTC-2369769K	P-UB-10	3 X 4-3/4	84.92
CTC-2378277	P-UB-10	2 X 4	43.66
CTC-2384462	P-UB-10	2 X 3	37.93
CTC-2384487	P-V-10	2 X 5	47.58
CTC-2384501	P-UB-10	2 X 4-1/4	36.00
CTC-2386661	P-UB-10	2 X 3-1/4	35.59
CTC-2386718	P-UB-10	2 X 4-1/2	35.01
CTC-2401661	P-UB-10	1-3/4 X 3-1/2	67.15
CTC-2401881	P-UB-10	1-3/4 X 3-1/2	60.88
CTC-2402016	P-UB-10	1-3/4 X 3	35.13
CTC-2402482	P-UB-10	1-3/4 X 2-3/4	34.76
CTC-2404819	P-UB-10	1-3/4 X 4	91.89
CTC-2406899	P-UB-10	2 X 4	45.10
CTC-2408525	P-UB-10	2 X 3-1/4	39.07
CTC-2409538	P-UB-10	2 X 4	62.36
CTC-2410109	P-UB-10	2in x 75mm	71.67
CTC-2410110	P-UB-10	2in x 85mm	96.93
CTC-2410895	P-UB-10	2-1/4 X 5	51.75
CTC-2410896	P-UB-10	2-1/4 X 4-1/2	63.99
CTC-2410897	P-UB-10	2-1/4 X 4-1/2	39.06
CTC-2410898	P-UB-10	2-1/4 X 4-1/4	47.93
CTC-2410900	P-UB-2	2-1/4 X 3-3/4	34.55
CTC-2410901	P-UB-10	2-1/4 X 4	46.92
CTC-2410902	P-UB-10	2-1/4 X 4-3/4	65.34
CTC-2417578	P-UB-10	2-1/4 X 5	53.84
CTC-2418924	P-UB-10	2-3/4 X 4-1/2	64.29
CTC-2418925	P-UB-10	2-3/8 X 4	47.77
CTC-2422542	P-UB-10	2-1/2 X 5	68.36
CTC-2422544	P-UB-10	2-1/2 X 7-1/4	68.57
CTC-2422546	P-UB-10	2-1/2 X 4-1/4	52.56
CTC-2422547	P-UB-10	2-1/2 X 4-1/4	48.41
CTC-2422548	P-UB-10	2-1/2 X 4	48.77
CTC-2422549	P-UB-10	2-1/2 X 6-1/2	74.86
CTC-2422550	P-UB-10	2-1/2 X 6	91.68
CTC-2422553	P-U-10	2-1/2 X 5	69.39
CTC-2422556	P-U-10	2-1/2 X 6	76.91
CTC-2422558	P-UB-10	2-1/2 X 6	56.89
CTC-2424270K	P-UB-10	3-1/4 X 6-1/4	164.99
CTC-2424271K	P-UB-10	3-1/4 X 5-3/4	214.34
CTC-2424272K	P-UB-10	3-1/4 X 5-3/4	214.34
CTC-2424273K	P-UB-10	3-1/4 X 170 mm	171.85
CTC-2426840	P-UB-10	105 X 150	148.46
CTC-2430381	P-UB-10	2-1/2 X 5-1/2	62.92
CTC-2430383	P-UB-10	2-1/2 X 5-1/2	53.34
CTC-2430397	P-UB-10	2-1/2 X 4	95.95
CTC-2435798	P-UB-10	2-1/2 X 4-1/2	63.98

Kit Number	Code (Pg. xiv)	Rod X Bore Size	List Price
CTC-2435805	P-UB-10	2-1/2 X 4-1/2	\$ 95.97
CTC-2435809	P-U-10	2-3/4 X 5	61.45
CTC-2435810	P-UB-10	2-3/4 X 5-1/4	105.14
CTC-2435811	P-UB-10	2-3/4 X 5	52.23
CTC-2435812	P-UB-10	2-3/4 X 6-1/2	113.09
CTC-2440953	P-UB-10	2-3/4 X 6	86.66
CTC-2440959	P-UB-10	2-3/4 X 4-1/4	84.60
CTC-2440964	P-UB-10	2-3/4 X 4-1/4	67.43
CTC-2440976	P-UB-10	3 X 4	60.79
CTC-2440980	P-UB-10	3 X 6-1/2	129.58
CTC-2442046	P-UB-10	3 X 7-1/4	128.18
CTC-2442049	P-UB-10	3 X 6-1/2	88.91
CTC-2442056	P-UB-10	3 X 7-1/4	105.95
CTC-2442060	P-UB-10	3-1/4 X 6	116.84
CTC-2442067	P-UB-10	3 X 7-1/4	113.25
CTC-2442073	P-UB-10	3 X 5-1/4	87.76
CTC-2442074	P-UB-10	3 X 5	73.32
CTC-2442079	P-UB-10	3-1/4 X 5-1/2	109.49
CTC-2448777K	P-UB-10	3-3/4 X 7-3/4	213.53
CTC-2450617	P-UB-10	3-1/4 X 6	153.68
CTC-2456815	P-V-10	1-1/4 X 4	27.01
CTC-2456824	P-UB-10	3-1/2 X 5-1/2	138.29
CTC-2456831	P-UB-10	3-1/2 X 7-1/2	181.67
CTC-2456835	P-UB-10	3-1/2 X 8-1/4	155.64
CTC-2457484K	P-UB-10	3-1/4 X 170 mm	171.85
CTC-2457487K	P-UB-10	3-1/2 X 7-1/2	206.64
CTC-2457491K	P-UB-10	3-1/4 X 6-1/4	164.99
CTC-2459835	P-UB-10	2-3/8, 3-3/4, 6	310.82
CTC-2460192K	P-UB-10	1-1/2 X 3	30.88
CTC-2460638	P-UB-10	3-1/2 X 8-1/4	103.39
CTC-2460649	P-UB-10	4 X 10-1/2	402.30
CTC-2463427	P-UB-10	4 X 8-1/2	146.10
CTC-2463439	P-UB-10	5-3/4 X 7	202.96
CTC-2465909	P-UB-10	1-1/2 X 2-3/4	61.47
CTC-2465911	P-UB-10	1-1/2 X 2-1/2	44.97
CTC-2465912	P-UB-10	1-1/2 X 2-3/4	45.67
CTC-2465913	P-UB-10	1-1/2 X 3	51.57
CTC-2465914	P-UB-10	1-1/2 X 3-1/2	65.63
CTC-2465915	P-UB-10	1-1/2 X 3-1/2	67.45
CTC-2465916	P-UB-10	1-1/2 X 2-1/4	45.61
CTC-2465922	P-UB-10	1-1/2 X 3	38.48
CTC-2465926	P-UB-10	1-7/8 X 3-1/4	53.84
CTC-2465927	P-UB-10	1-7/8 X 3	92.70
CTC-2465929	P-UB-10	2-1/8 X 4	36.57
CTC-2478790	P-UB-10	85 X 120	86.07
CTC-2478792	P-UB-10	100 X 140	156.74
CTC-2478868	P-UB-10	85 X 120	135.35
CTC-2478878	P-UB-10	100 X 140	166.54
CTC-2478888	P-UB-10	85 X 120	115.90
CTC-2478974	P-UB-10	100 X 140	166.54
CTC-2478996	P-UB-10	85 X 120	137.75
CTC-2478998	P-UB-10	85 X 120	137.75

CATERPILLAR®



REPLACEMENT KITS FOR CATERPILLAR® EQUIPMENT

NOTE: Caterpillar® kit numbers are used as a reference only. We do not imply that these kits are original REPLACEMENT KITS.

Kit Number	Code (Pg. xiv)	Rod X Bore Size	List Price	Kit Number	Code (Pg. xiv)	Rod X Bore Size	List Price
CTC-2479000	P-UB-10	85 X 120	\$ 125.36	CTC-2668015	P-UB-10	100 X 140	\$ 118.16
CTC-2479001	P-UB-10	85 X 120	125.36	CTC-2668016	P-UB-10	105 X 150	284.06
CTC-2479005	P-UB-10	85 X 125	127.30	CTC-2668045	P-UB-10	95 X 135	113.49
CTC-2481162	P-UB-10	100 X 140 mm	152.74	CTC-2668057	P-UB-10	85 X 120	115.90
CTC-2481165	P-UB-10	100 X 140	136.82	CTC-2737025K	P-U-10	55 X 100	92.96
CTC-2502475	P-UB-10	105 X 150	115.12	CTC-2742460	P-UB-10	110 X 160	223.74
CTC-2502485	P-UB-10	100 X 140	139.38	CTC-2742461	P-UB-10	130 X 190	368.60
CTC-2502487	P-UB-10	85 X 120 mm	119.50	CTC-2742462	P-UB-10	110 X 170	227.79
CTC-2519341	P-UB-10	100 X 170	223.79	CTC-2742511	P-UB-10	85 X 120	99.56
CTC-2521191	P-UB-10	95 X 160	165.19	CTC-2742515	P-UB-10	100 X 140	143.27
CTC-2578422	P-UB-10	2-3/8 X 3-3/4	44.74	CTC-2773395	P-UB-14	55 X 95	81.99
CTC-2580313	P-UB-10	85 X 130	116.45	CTC-2774140	P-UB-14	50 X 85	69.15
CTC-2580500	P-UB-10	85 X 120	123.09	CTC-2774167	P-UB-14	45 X 75	107.88
CTC-2590625	P-UB-10	90 X 130	135.18	CTC-2788641	P-U-10	45 X 80	62.15
CTC-2590626	P-UB-10	90 X 130	118.68	CTC-2790639	P-U-10	50 X 85	69.13
CTC-2590627	P-UB-10	90 X 130	118.68	CTC-2797940	P-U-10	45 X 80	66.31
CTC-2590628	P-UB-10	90 X 130	135.18	CTC-2821535K	P-U-10	55 X 100	92.98
CTC-2590631	P-UB-10	100 X 140	130.38	CTC-2821537K	P-U-10	55 X 90	64.23
CTC-2590632	P-UB-10	100 X 140	127.95	CTC-2839122	P-U-10	35 X 65	36.22
CTC-2590633	P-UB-10	100 X 140	130.38	CTC-2897878K	P-UB-10	90 X 130	135.64
CTC-2590634	P-UB-10	100 X 140	127.95	CTC-2937158K	P-U-10	55 X 90	65.09
CTC-2590635	P-UB-10	100 X 140	130.38	CTC-2937596	P-UB-10	2 X 3	33.87
CTC-2590636	P-UB-10	105 X 150	291.00	CTC-2949583	P-UB-10	2-1/2 X 3-1/2	59.35
CTC-2590637	P-UB-10	105 X 150	291.00	CTC-2950145	I-UB-10	5-1/2 X 7-1/2	215.64
CTC-2590648	P-UB-10	100 X 140	123.68	CTC-2950147	P-U-3	7 X 8-1/2	233.39
CTC-2590650	P-UB-10	105 X 150	284.06	CTC-2950148	P-UB-3	7 X 8	554.50
CTC-2590656	P-UB-10	95 X 135	112.38	CTC-2950148AV	P-SP-3	7 X 8	505.12
CTC-2590678	P-UB-10	90 X 130	110.14	CTC-2959885	P-UB-1	9 X 10-1/2	223.16
CTC-2590695	P-UB-10	85 X 120	137.75	CTC-2959886	P-U-3	7 X 8-1/2	232.53
CTC-2590699	P-UB-10	100 X 140	130.38	CTC-2959888	P-UB-10	3-1/2 X 6-1/4	174.53
CTC-2590706	P-UB-10	85 X 120	125.36	CTC-2959892	P-UB-10	3-1/2 X 5-1/2	127.33
CTC-2590712	P-UB-10	90 X 130	136.60	CTC-2959895	P-UB-10	130 X 180	252.96
CTC-2590719	P-UB-10	90 X 130	120.10	CTC-2976848	P-U-3	7 X 8-1/2	240.78
CTC-2590725	P-UB-10	100 X 140	127.95	CTC-2976849	P-U-1	9 X 10-1/2	331.77
CTC-2590729	P-UB-10	105 X 150	291.00	CTC-2976852	P-UB-1	9 X 10-3/4	1419.08
CTC-2590743	P-UB-10	105 X 150	105.92	CTC-3087849	P-UB-1	9 X 10-3/4	1419.08
CTC-2590751	P-UB-10	110 X 160	194.75	CTC-3126388	I-SP-10	5,7-1/2X 6-1/2, 8-1/4	406.30
CTC-2590768	P-UB-10	115 X 170	273.44	CTC-3170942	I-UB-10	5-1/2 X 9-1/2	309.62
CTC-2590775	P-UB-10	100 X 140	166.54	CTC-3E3293	P-UB-10	3 X 5-1/4	150.34
CTC-2590779	P-UB-10	105 X 150	271.28	CTC-3E3297	P-UB-10	1-7/8 X 3-1/4	83.37
CTC-2594733K	P-UB-10	2-1/2 X 4	72.04	CTC-3E3299	P-UB-10	2-1/2 X 3-1/2	113.42
CTC-2594737K	P-UB-10	2-1/2 X 4	72.04	CTC-3E3300	P-UB-10	2-1/2 X 4-1/4	90.91
CTC-2601518	P-UB-10	2-3/4 X 5-1/2	104.07	CTC-3E3301	P-UB-10	4-3/4 X 7	173.41
CTC-2605317	P-UB-10	80 X 110	180.72	CTC-3E8877	P-UB-10	2-3/8 X 4-1/2	150.30
CTC-2618001	P-UB-10	2-3/4 X 6	118.06	CTC-3E8878	P-UB-10	2-3/4 X 5	154.05
CTC-2666967K	P-U-10	50 X 80	84.36	CTC-3E8880	P-UB-10	5-3/4 X 8-1/4	611.83
CTC-2666975K	P-U-10	55 X 90	65.09	CTC-3E8887	P-UB-10	5 X 7-3/4	379.89
CTC-2666977K	P-U-10	55 X 90	65.09	CTC-3E8888	P-UB-10	3-3/4 X 6	267.80
CTC-2667891	P-UB-10	85 X 120	135.35	CTC-3E8889	P-UB-10	3-1/2 X 6	148.46
CTC-2667892	P-UB-10	85 X 120	115.90	CTC-3G0688K	I-SP-1	7 X 8-1/2	178.67
CTC-2668011	P-UB-10	85 X 120	135.35	CTC-4C4784	D-RING KIT		134.81
CTC-2668012	P-UB-10	100 X 140	166.54	CTC-4C8253	SILICONE O-RING KIT		363.12

NORTH AMERICA
PHONE 1-800-777-5617
FAX 1-800-759-6391

SALES OFFICE HOURS
8 A.M. TO 8 P.M. EASTERN TIME
www.HerculesUS.com

WORLDWIDE
PHONE 1-727-796-1300
FAX 1-727-797-8849

REPLACEMENT KITS FOR CATERPILLAR® EQUIPMENT

NOTE: Caterpillar® kit numbers are used as a reference only. We do not imply that these kits are original REPLACEMENT KITS.

Kit Number	Code (Pg. xiv)	Rod X Bore Size	List Price	Kit Number	Code (Pg. xiv)	Rod X Bore Size	List Price
CTC-4I3665	P-UB-10	85 X 120 mm	\$ 264.78	CTC-7X2667	P-UB-10	2-1/2 X 4-1/2	\$ 80.82
CTC-4I3668	P-UB-10	100X140 mm	260.30	CTC-7X2668	P-UB-10	2-1/2 X 4-1/2	143.84
CTC-4I7664	P-UB-10	65 X 100 mm	172.96	CTC-7X2669	P-UB-14	2-1/2 X 6	197.74
CTC-4I8913	P-UB-10	75 X 110 mm	246.15	CTC-7X2670	P-UB-10	2-1/2 X 3-3/4	77.50
CTC-4I8914	P-UB-10	65 X 100 mm	172.89	CTC-7X2671	P-UB-10	2-1/2 X 5-1/2	125.31
CTC-4J4627K	I-P-V-10	1-1/2 X 3-1/2	70.75	CTC-7X2672	P-UB-10	2-1/2 X 5-1/2	75.10
CTC-4J8770K	I-SP-1	7 X 8-1/2	181.80	CTC-7X2673	P-UB-10	2-1/2 X 4-3/4	150.91
CTC-514131	P-V-10	2-1/2 X 9-1/2	103.67	CTC-7X2674	P-UB-10	2-1/2 X 6	109.31
CTC-5I3047	P-UB-10	80 X 120 mm	207.12	CTC-7X2675	P-UB-10	2-1/2 X 5	105.11
CTC-5I8893	P-UB-10	150 X 220 mm	675.88	CTC-7X2676	P-V-10	2-1/2 X 6-1/2	92.56
CTC-5J6572K	I-SP-1	7 X 8-1/2	178.67	CTC-7X2677	P-V-10	2 X 4-3/4	99.00
CTC-5U7775	I-U-3	3-1/2 X 5-1/2	272.25	CTC-7X2678	P-V-10	2-1/2 X 6-1/2	92.56
CTC-6C6091	P-UB-10	95 X 160 mm	284.91	CTC-7X2679	P-UB-10	2-1/2 X 6	116.87
CTC-6E0525K	P-U-14	4-1/4 X 7-3/4	324.22	CTC-7X2680	P-UB-10	2-3/4 X 6	115.89
CTC-6E4057	N-N-10		18.10	CTC-7X2681	P-UB-10	2-3/4 X 7-1/4	96.09
CTC-6J1203K	I-UB-10	2-3/8 X 3-3/4	99.45	CTC-7X2682	P-UB-10	2-3/4 X 5	132.07
CTC-6U9552	I-U-5	2 X 4-1/2	188.77	CTC-7X2683	P-UB-14	2-3/4 X 4-1/2	154.55
CTC-711436	I-U-3	11 X 13-1/8	1015.77	CTC-7X2684	P-UB-10	2-3/4 X 5-1/2	129.90
CTC-712436	P-U-3	11 X 13-1/8	1085.86	CTC-7X2685	P-UB-14	2-3/4 X 4-1/2	138.92
CTC-713437	I-U-3	11 X 12-1/2	350.55	CTC-7X2686	P-UB-14	2-3/4 X 6-1/2	102.12
CTC-714437	P-U-3	11 X 12-1/2	374.87	CTC-7X2687	P-UB-10	2-3/4 X 7-1/4	225.35
CTC-715438	I-SP-10	7-1/4, 10-1/2	622.71	CTC-7X2688	P-UB-14	2-3/4 X 6-1/4	125.16
CTC-716439	I-SP-10	7-1/4, 11	636.82	CTC-7X2689	P-UB-10	2-3/4 X 6-1/2	136.20
CTC-717440	I-U-3	12-1/2 X 15-1/8	1468.39	CTC-7X2690	P-UB-10	2-3/4 X 5-1/2	84.20
CTC-718440	P-U-3	12-1/2 X 15-1/8	1468.18	CTC-7X2691	P-UB-14	2-3/4 X 7	123.99
CTC-719441	I-U-3	12-1/2 X 14-1/4	618.55	CTC-7X2692	P-UB-10	2-1/2 X 6	138.95
CTC-720441	P-U-3	12-1/2 X 14-1/4	508.26	CTC-7X2694	P-UB-10	3 X 6-1/2	134.38
CTC-728446	P-UB-10	9 X 10-3/4	1182.59	CTC-7X2695	P-UB-10	3 X 8-1/4	300.68
CTC-7751023	I-U-3	13-1/2 X 16-1/8	1436.60	CTC-7X2697	P-UB-10	3 X 6-1/4	133.81
CTC-7761023	P-U-3	13-1/2 X 16-1/8	1414.33	CTC-7X2698	P-UB-10	3 X 6	157.60
CTC-778441	P-U-3	12-1/2 X 14-1/4	1176.45	CTC-7X2699	P-UB-14	3 X 7-1/4	182.12
CTC-7I0968	P-UB-10	2-1/2 X 4	122.31	CTC-7X2700	P-V-10	2 X 4-1/2	60.03
CTC-7I1360	P-UB-10	90 X 130 mm	250.92	CTC-7X2701	P-UB-14	3 X 6-1/4	95.33
CTC-7T4515	O-RING KIT		4.77	CTC-7X2702	P-UB-10	3 X 7-1/4	240.14
CTC-7U2486	I-U-10	4 X 4-1/2	273.10	CTC-7X2703	P-UB-14	3-1/4 X 8-1/4	199.38
CTC-7U8075	I-U-10	2-3/4 X 4	216.60	CTC-7X2704	P-UB-10	3-1/4 X 7	119.62
CTC-7U9545	I-UB-5	2 X 4-1/2	261.36	CTC-7X2705	P-UB-10	3-1/4 X 5-1/2	218.24
CTC-7X0863	P-UB-10	3-1/2 X 6-1/4	142.99	CTC-7X2706	P-UB-10	3-1/4 X 7-3/4	225.60
CTC-7X2451	P-UB-10	2-3/4 X 4-1/4	93.80	CTC-7X2707	P-UB-10	3-1/4 X 9-1/4	292.80
CTC-7X2653	P-UB-10	2-1/2 X 5-1/2	137.42	CTC-7X2707A	P-UB-10	3-1/4 X 9-1/4	235.41
CTC-7X2655	P-UB-10	2-1/2 X 6	96.10	CTC-7X2708	P-UB-10	3-1/4 X 9-1/4	172.39
CTC-7X2656	P-UB-10	2-1/2 X 6	136.40	CTC-7X2709	P-UB-14	3-1/4 X 5-1/2	136.64
CTC-7X2658	P-UB-10	2-1/2 X 5	147.39	CTC-7X2710	P-UB-10	3-1/4 X 7	219.31
CTC-7X2659	P-UB-10	2-1/2 X 4	132.61	CTC-7X2711	P-UB-10	3-1/4 X 6-1/2	177.37
CTC-7X2660	P-UB-10	2-1/2 X 4-3/4	151.93	CTC-7X2712	P-UB-10	3-1/4 X 5-1/2	78.37
CTC-7X2660A	P-UB-10	2-1/2 X 4-3/4	143.13	CTC-7X2713	P-UB-14	3-1/4 X 6-1/2	113.05
CTC-7X2661	P-UB-10	2-1/2 X 7-1/4	153.05	CTC-7X2714	P-UB-14	3-1/4 X 5-1/2	136.64
CTC-7X2662	P-UB-10	2-1/2 X 6	144.88	CTC-7X2715	P-UB-10	3-1/4 X 8-1/4	224.12
CTC-7X2663	P-UB-10	2-1/2 X 4-1/4	41.78	CTC-7X2716	P-UB-10	3-1/4 X 9-1/4	135.00
CTC-7X2664	P-UB-10	2-1/2 X 4-1/4	75.62	CTC-7X2717	P-UB-14	3-1/4 X 8-1/4	171.10
CTC-7X2665	P-UB-10	2-1/2 X 4	141.19	CTC-7X2718	P-UB-10	3-1/4 X 7-1/4	168.04
CTC-7X2666	P-UB-10	2-1/2 X 6-1/2	143.68	CTC-7X2719	P-UB-10	3-1/2 X 8-1/2	158.89

CATERPILLAR®



REPLACEMENT KITS FOR CATERPILLAR® EQUIPMENT

NOTE: Caterpillar® kit numbers are used as a reference only. We do not imply that these kits are original REPLACEMENT KITS.

Kit Number	Code (Pg. xiv)	Rod X Bore Size	List Price	Kit Number	Code (Pg. xiv)	Rod X Bore Size	List Price
CTC-7X2720	P-UB-10	3-1/2 X 8-1/4	\$ 152.83	CTC-7X2795	P-UB-10	2-1/4 X 4	\$ 89.30
CTC-7X2721	P-UB-10	3-1/2 X 8-1/4	246.28	CTC-7X2797	P-V-10	2 X 5	59.98
CTC-7X2722	P-UB-10	3-1/2 X 7-1/2	157.13	CTC-7X2798	P-UB-10	2-1/4 X 3-3/4	64.20
CTC-7X2724	P-UB-14	3-1/2 X 8-1/4	171.87	CTC-7X2799	P-UB-10	4 X 9-1/4	302.65
CTC-7X2725	P-UB-10	3-1/2 X 8-1/4	329.13	CTC-7X2801	P-UB-10	3-1/4 X 8-1/4	206.70
CTC-7X2726	P-UB-14	3-1/2 X 5-1/2	127.19	CTC-7X2802	P-UB-10	2-1/4 X 4	77.55
CTC-7X2727	P-UB-14	3-1/2 X 8-1/4	291.27	CTC-7X2803	P-UB-10	2-3/4 X 6	144.98
CTC-7X2728	P-UB-10	3-1/2 X 8-1/4	147.99	CTC-7X2804	P-UB-14	2-3/4 X 6-1/2	181.44
CTC-7X2729	P-UB-10	2-1/4 X 5	137.33	CTC-7X2806	P-UB-10	2 X 3-1/2	102.63
CTC-7X2730	P-UB-14	3-1/2 X 7-1/2	135.37	CTC-7X2808	P-UB-10	2-3/8 X 3-3/4	68.21
CTC-7X2731	P-UB-10	3-3/4 X 6-1/2	219.13	CTC-7X2809	P-UB-10	7 X 11-1/2	350.62
CTC-7X2734	P-UB-10	4 X 8-1/2	256.24	CTC-7X2810	P-UB-14	4 X 10	195.25
CTC-7X2736	P-UB-10	1-1/2 X 2-3/4	106.91	CTC-7X2811	P-UB-14	4 X 10	232.23
CTC-7X2737	P-UB-10	1-1/2 X 3	91.86	CTC-7X2812	P-UB-10	1-1/2 X 3-1/2	88.00
CTC-7X2738	P-UB-10	1-1/2 X 4	73.99	CTC-7X2813	P-UB-10	3 X 5-1/2	192.04
CTC-7X2739	P-UB-10	1-1/2 X 2-1/2	47.83	CTC-7X2814	P-UB-14	3-3/4 X 6	167.97
CTC-7X2741	P-UB-10	1-1/2 X 3-1/4	61.32	CTC-7X2815	P-UB-10	2-1/4 X 4-3/4	81.81
CTC-7X2742	P-UB-14	4 X 8-1/2	182.87	CTC-7X2816	P-UB-10	4 X 5	213.89
CTC-7X2743	P-UB-10	2-1/2 X 5	95.04	CTC-7X2818	P-UB-10	2-1/4 X 3-1/2	\$ 76.31
CTC-7X2745	P-UB-10	1-1/2 X 3	91.86	CTC-7X2819	P-UB-10	2 X 4-1/4	88.92
CTC-7X2747	P-UB-10	2-1/4 X 4-1/2	158.04	CTC-7X2820	P-UB-10	1-3/4 X 2-3/4	66.93
CTC-7X2748	P-UB-10	2-1/4 X 4-1/2	91.01	CTC-7X2821	P-UB-10	2 X 3-1/4	118.51
CTC-7X2749	P-UB-10	1-1/2 X 2-3/4	49.96	CTC-7X2822	P-U-10	2 X 3-1/2	80.82
CTC-7X2750	P-UB-10	2-1/4 X 4-1/4	96.77	CTC-7X2823	P-UB-10	3-1/4 X 5-1/2	200.54
CTC-7X2751	P-UB-10	1-1/2 X 3	54.17	CTC-7X2824	P-U-10	2-3/4 X 5	100.59
CTC-7X2752	P-UB-10	1-1/2 X 3-1/2	80.70	CTC-7X2825	P-UB-10	1-3/4 X 3	42.17
CTC-7X2753	P-UB-10	2 X 3	50.05	CTC-7X2826	P-UB-10	1-1/2 X 2-1/4	34.46
CTC-7X2755	P-UB-10	2 X 4	115.58	CTC-7X2836	P-UB-14	2-1/2 X 6	217.33
CTC-7X2755A	P-UB-10	2 X 4	79.98	CTC-7X7718	P-UB-10	4-3/4 X 6-1/2	212.51
CTC-7X2756	P-UB-10	3 X 5-1/4	106.96	CTC-7X7719	P-UB-10	4-3/4 X 6-1/2	224.73
CTC-7X2757	P-UB-10	3-1/4 X 6	226.37	CTC-7X7734	P-UB-10	4-3/4 X 7	366.69
CTC-7X2760	P-UB-10	2 X 3	54.39	CTC-7X7735	P-UB-10	3-1/2 X 6	186.31
CTC-7X2762	P-UB-10	1-3/4 X 3-1/2	84.64	CTC-7X7937	P-UB-10	2 X 4	126.05
CTC-7X2763	P-V-10	2 X 5	114.58	CTC-7X7938	P-UB-10	2 X 3-3/4	88.49
CTC-7X2764	P-UB-10	1-3/4 X 3-1/4	54.01	CTC-7Y4698	P-UB-10	105 X 150 mm	284.41
CTC-7X2765	P-UB-14	4 X 6-1/2	199.38	CTC-7Y5145	P-UB-10	85 X 130 mm	226.08
CTC-7X2766	P-UB-10	2 X 4-1/4	37.33	CTC-7Y5147	P-UB-10	95 X 130 mm	252.83
CTC-7X2767	P-UB-10	2 X 3-1/4	54.31	CTC-8C3316	P-UB-10	1-1/2 X 3-1/2	44.92
CTC-7X2768	P-UB-10	2 X 4-1/2	75.01	CTC-8C3317	P-UB-10	1-1/2 X 2-3/4	41.92
CTC-7X2769	P-UB-10	2 X 3-1/2	95.48	CTC-8C3319	P-UB-10	1-3/4 X 4	41.32
CTC-7X2770	P-V-10	2 X 4-1/2	82.84	CTC-8C3408	P-UB-10	2 X 3-1/2	50.34
CTC-7X2773	P-UB-10	2-1/2 X 4-3/4	150.91	CTC-8C4029	P-UB-10	1-1/2 X 3	29.69
CTC-7X2783	P-UB-10	2 X 3-1/2	87.11	CTC-8C4398	P-UB-10	5-3/4 x 7	301.84
CTC-7X2784	P-UB-10	1-3/4 X 3-1/2	47.66	CTC-8C5768	P-UB-10	2-1/2 X 6	83.91
CTC-7X2785	P-UB-10	2 X 4	69.16	CTC-8C5788	I-SP-10, 3	7-1/4, 11 X 9-1/2, 12-1/4	894.07
CTC-7X2787	P-UB-10	2 X 3-1/4	76.39	CTC-8C6896	P-UB-10	2-1/2 X 4-3/4	77.00
CTC-7X2788	P-UB-10	2 X 5	94.88	CTC-8C6958	P-UB-10	4-1/2 X 6	219.00
CTC-7X2789	P-UB-10	2 X 4	86.29	CTC-8C9353	P-UB-10	2 X 4	47.30
CTC-7X2790	P-UB-10	1-3/4 X 4	78.63	CTC-8C9438	P-UB-10	2 X 4-1/2	59.74
CTC-7X2791	P-UB-10	1-3/4 X 3	74.94	CTC-8J8902K	I-SP-1	9 X 10-1/2	403.71
CTC-7X2792	P-UB-10	2 X 3-1/2	74.25	CTC-8T1370	P-UB-10	2 X 4	44.46
CTC-7X2794	P-UB-10	3-3/4 X 6	326.95	CTC-8T1371	P-UB-10	1-3/4 X 4	42.35

NORTH AMERICA
PHONE 1-800-777-5617
FAX 1-800-759-6391

SALES OFFICE HOURS
8 A.M. TO 8 P.M. EASTERN TIME
www.HerculesUS.com

WORLDWIDE
PHONE 1-727-796-1300
FAX 1-727-797-8849

CATERPILLAR®

REPLACEMENT KITS FOR CATERPILLAR® EQUIPMENT

NOTE: Caterpillar® kit numbers are used as a reference only. We do not imply that these kits are original REPLACEMENT KITS.

Kit Number	Code (Pg. xiv)	Rod X Bore Size	List Price
CTC-8T1372	P-UB-10	1-1/2 X 3-1/2	\$ 38.96
CTC-8T1373	P-UB-10	1-3/4 X 3	33.69
CTC-8T1374	P-UB-10	2-1/2 X 5-1/2	79.00
CTC-8T1375	P-UB-10	2-1/2 X 5	56.92
CTC-8T1376	P-UB-10	2-1/2 X 6-1/2	67.29
CTC-8T1378	P-UB-10	2-1/2 X 4	57.45
CTC-8T1380	P-UB-10	2 X 3-1/2	44.69
CTC-8T1381	P-UB-10	2-1/2 X 4-3/4	65.53
CTC-8T1382	P-UB-10	1-1/2 X 4	31.56
CTC-8T1383	P-UB-10	2-3/4 X 6-1/2	70.66
CTC-8T1384	P-UB-10	4 x 8-1/2	264.23
CTC-8T1385	P-UB-10	2-1/4 X 5	80.35
CTC-8T1386	P-UB-10	2 X 4	68.82
CTC-8T1388	P-UB-10	1-3/4 X 3-1/2	39.13
CTC-8T1389	P-UB-10	2-3/8 X 4	40.27
CTC-8T1390	P-V-10	2 X 5	68.42
CTC-8T1391	P-UB-10	3-1/4 X 6-1/4	78.37
CTC-8T1395	P-UB-10	2-1/4 X 4-1/2	54.33
CTC-8T1396	P-UB-10	2-1/4 X 4-1/2	47.47
CTC-8T1398	P-UB-14	3-1/4 X 5-1/2	175.39
CTC-8T1400	P-UB-10	3 X 6-1/2	68.30
CTC-8T1401	P-V-10	3-1/2 X 8-1/4	132.61
CTC-8T1402	P-UB-10	1-1/2 X 2-3/4	41.92
CTC-8T1403	P-V-10	2-1/2 X 6	99.03
CTC-8T1404	P-UB-10	2-3/4 X 7-1/4	93.26
CTC-8T1405	P-UB-10	3 X 8-1/4	125.39
CTC-8T1406	P-V-10	2-1/2 X 5	60.49
CTC-8T1408	P-UB-10	3 X 6-1/2	68.30
CTC-8T1410	P-UB-10	3-1/2 X 8-1/4	124.50
CTC-8T1411	P-UB-10	3-1/4 X 9-1/4	143.00
CTC-8T1412	P-UB-10	2 X 4-1/4	37.33
CTC-8T1413	P-UB-10	2-1/4 X 4-1/4	56.14
CTC-8T1415	P-V-10	6 X 8-1/4	250.25
CTC-8T1416	P-UB-10	2-1/2 X 7-1/4	77.00
CTC-8T1417	P-UB-10	2-3/4 X 7-1/4	96.09
CTC-8T1418	P-V-10	2-1/2 X 6	103.67
CTC-8T1419	P-UB-10	2 X 4-1/2	48.13
CTC-8T1420	P-UB-10	2 X 3-1/2	46.44
CTC-8T1421	P-V-10	2 X 4-3/4	70.51
CTC-8T1422	P-V-10	2-1/2 X 6	99.03
CTC-8T1428	P-UB-10	3 X 5-1/4	106.96
CTC-8T1430	P-UB-10	3-1/4 X 9-1/4	124.28
CTC-8T1435	P-UB-10	1-1/2 X 3	36.99
CTC-8T1438	P-UB-10	2-1/2 X 4-1/4	53.08
CTC-8T1439	P-UB-10	2-1/4 X 4	53.86
CTC-8T1451	P-UB-10	3 X 6-1/4	79.27
CTC-8T1456	P-UB-14	6-1/2 X 10-1/2	311.67
CTC-8T1457	P-UB-10	4 X 7	162.48
CTC-8T1461	P-UB-10	4-1/4 X 6-1/2	192.50
CTC-8T1462	P-UB-14	4-3/4 X 6-1/2	205.96
CTC-8T1464	P-UB-10	2-3/8 X 4-1/4	45.35
CTC-8T1466	P-UB-10	2-1/2 X 4	55.37

Kit Number	Code (Pg. xiv)	Rod X Bore Size	List Price
CTC-8T1468	P-UB-10	3-1/2 X 8-1/4	\$ 105.51
CTC-8T1472	P-UB-10	2-1/2 X 6-1/2	68.92
CTC-8T1474	P-UB-10	4 X 9-1/4	336.88
CTC-8T1477	P-UB-14	3-1/2 X 8-1/4	171.13
CTC-8T1478	P-UB-10	3-1/4 X 7	154.00
CTC-8T1479	P-UB-10	5 X 7-3/4	305.24
CTC-8T1480	P-V-10	1-1/4 X 4	69.97
CTC-8T1484	P-UB-10	2-1/4 X 4	53.03
CTC-8T1488	P-V-10	2-1/2 X 6	87.76
CTC-8T1489	P-UB-10	3 X 6	108.20
CTC-8T1525	P-UB-10	2-3/4 X 5-1/2	82.26
CTC-8T1527	P-UB-10	2-3/4 X 5	62.57
CTC-8T1532	P-V-10	2 X 3-1/2	53.65
CTC-8T1534	P-UB-10	2-1/2 X 4-1/2	54.70
CTC-8T1543	I-UB-10	5-1/2 X 9-1/2	368.12
CTC-8T1545	P-UB-14	4-3/4 X 7-1/4	244.45
CTC-8T1548	P-UB-10	1-1/2 X 3-1/2	40.57
CTC-8T1549	P-UB-14	3 X 5-1/2	152.01
CTC-8T1551	P-UB-14	3 X 7-1/4	152.63
CTC-8T1553	P-V-10	2-3/4 X 6	95.56
CTC-8T1554	P-V-14	2-3/4 X 6-1/2	116.53
CTC-8T1555	P-UB-14	3-1/4 X 6-1/2	150.11
CTC-8T1558	P-UB-10	5-3/4 X 8-1/4	522.85
CTC-8T1559	P-UB-10	3-1/2 X 8-1/4	95.01
CTC-8T1565	P-UB-14	4-3/4 X 7	207.62
CTC-8T1566	P-UB-14	3-1/4 X 6-1/2	150.17
CTC-8T1567	P-UB-14	4-3/4 X 7	201.67
CTC-8T1908	P-UB-14	4-3/4 X 6	184.25
CTC-8T1909	P-UB-10	5 X 6	285.70
CTC-8T2066	P-UB-10	2-1/2 X 6	89.45
CTC-8T2166	P-UB-10	3-1/4 X 8-1/4	112.06
CTC-8T2216	P-UB-10	2-1/4 X 4-3/4	66.53
CTC-8T2583	P-UB-14	3-1/2 X 8-1/2	161.95
CTC-8T3574	P-UB-10	2-1/4 X 3-1/2	42.62
CTC-8T3575	P-UB-10	2 X 4-1/4	38.29
CTC-8T3576	P-UB-10	2-1/2 X 5-1/2	76.44
CTC-8T3589	P-UB-10	1-7/8 X 3-1/4	68.36
CTC-8T3591	P-UB-10	2-1/8 X 3-1/2	88.74
CTC-8T3593	P-UB-10	2-1/8 X 4	60.05
CTC-8T3648	P-UB-10	3-1/4 X 9-1/4	124.28
CTC-8T3740	P-UB-10	3 X 7-1/4	100.80
CTC-8T3852	P-UB-10	1-7/8 X 3	163.17
CTC-8T4770	P-UB-10	3-1/4 X 7-1/4	80.98
CTC-8T4772	I-SP-10	4, 6-1/2 X 5-3/4	266.06
CTC-8T4939	I-SP-10, 3	7-1/4, 10-1/2 X 9-1/4, 11-1/2	654.05
CTC-8T4940	P-V-10	2-3/4 X 5	72.73
CTC-8T9042	I-SP-10	5,7-1/2 X 8-1/4	385.00
CTC-933045	P-UB-15	50 X 90 mm	244.49
CTC-938385	P-UB-15	70 X 110 mm	179.67
CTC-938388	P-UB-15	80 X 120 mm	291.92
CTC-938390	P-UB-15	60 X 110 mm	286.26
CTC-939941	P-UB-14	90 X 140 mm	258.95

CATERPILLAR®



REPLACEMENT KITS FOR CATERPILLAR® EQUIPMENT

NOTE: Caterpillar® kit numbers are used as a reference only. We do not imply that these kits are original REPLACEMENT KITS.

Kit Number	Code (Pg. xiv)	Rod X Bore Size	List Price	Kit Number	Code (Pg. xiv)	Rod X Bore Size	List Price
CTC-940691	P-UB-10	85 X 125 mm	\$ 273.02	CTC-9X6024	P-SP-10	2-1/2 X 6-1/2	\$ 129.79
CTC-941910	P-UB-10	100 X 140 mm	325.87	CTC-9X6254	P-UB-10	4-1/4 X 6-1/2	204.72
CTC-942697	P-UB-14	100 X 150 mm	216.56	CTC-9X6255	P-UB-10	4-1/4 X 6-1/2	207.01
CTC-942698	P-UB-14	100 X 160 mm	329.70	CTC-9X6261	P-UB-10	4 X 6	240.22
CTC-964395	P-UB-10	85 X 120 mm	329.01	CTC-9X6263	P-UB-10	4 X 6	197.92
CTC-964396	P-UB-10	95 X 130 mm	363.00	CTC-9X6379	P-UB-10	4-1/4 X 6-1/2	268.52
CTC-966457	P-UB-10	75 X 115 mm	305.11	CTC-9X6392	P-UB-10	2-1/4 X 5	135.36
CTC-967799	P-UB-10	80 X 120 mm	287.90	CTC-9X6393	P-UB-10	3-3/4 X 6	231.17
CTC-995310	P-UB-14	75 X 110 mm	229.97	CTC-C75300011	P-UB-13	70 X 110 mm	187.47
CTC-995311	P-UB-14	80 X 120 mm	245.43	CTC-C75300021	P-UB-13	80 X 120 mm	179.27
CTC-995312	P-UB-14	65 X 100 mm	249.27	CTC-C75300031	P-UB-13	65 X 110 mm	188.08
CTC-9S3135	Split Flange O-Ring Kit		47.02	CTC-C95300623	P-UB-10	80 X 120 mm	234.36
CTC-9T0418	I-O-3	1 X 2	70.20	CTC-C95300731	P-UB-10	65 X 100 mm	160.87
CTC-9T3972K	I-SP-1	9 X 10-1/2	403.71	CTC-C95301729	P-UB-10	75 X 110 mm	164.70
CTC-9T7125	P-SP-1	1" Rod Kit	12.38	CTC-E25300061	P-UB-14	90 X 140 mm	358.80
CTC-9T8912K	I-U-1	2-3/4 X 5-1/2	125.73	CTC-E35300040	P-UB-10	85 X 125 mm	273.02
CTC-9X2020	I-UB-10	2-3/4 X 3-3/4	92.07	CTC-E75300010	P-UB-10	100 X 140 mm	325.87
CTC-9X2047	P-UB-10	2-1/2 X 5-1/2	91.52	CTC-E85300011	P-UB-10	85 X 120 mm	329.01
CTC-9X2050	P-UB-10	2-1/2 X 5-1/2	85.17	CTC-E85300021	P-UB-10	95 X 130 mm	363.00
CTC-9X2151	P-UB-10	2-1/2 X 4-3/4	70.25	CTC-E85300031	P-UB-10	75 X 115 mm	305.11
CTC-9X2400	P-UB-10	2-1/8 X 4	100.80	CTC-F15300011	P-UB-14	100 X 150 mm	397.37
CTC-9X2473	P-UB-10	2-3/4 X 6-1/2	113.83	CTC-F15300021	P-UB-14	110 X 160 mm	329.70
CTC-9X2644	P-UB-10	3-1/2 X 7-3/4	196.08				

REPLACEMENT PARTS FOR CATERPILLAR® EQUIPMENT

NOTE: Caterpillar® kit numbers are used as a reference only. We do not imply that these kits are original REPLACEMENT KITS.

ROD BUSHINGS

Part Number	Rod Dia.	List Price
CTC-0964402	85 mm	\$ 27.84
CTC-0965625	100 mm	41.45
CTC-0995572	105 mm	35.65
CTC-1052575	90 mm	26.85
CTC-1140750	75 mm	24.84
CTC-1140751	60 mm	19.41
CTC-1140754	65 mm	20.58
CTC-1140755	80 mm	27.24

ROD BUSHINGS

Part Number	Rod Dia.	List Price
CTC-1140756	85 mm	29.72
CTC-1140757	100 mm	41.78
CTC-1140758	90 mm	34.28
CTC-6C6093	95 mm	38.29

SELF-ALIGNING BALL BUSHINGS

Part Number	Rod Dia.	List Price
CTC-9M3914	3/4"	21.27
CTC-58639	1"	18.52
CTC-2D8652	1-1/4"	26.73
CTC-4D0298	1-1/2"	34.98
CTC-4D4431	1-3/4"	48.01
CTC-9M1328	2"	65.15
CTC-6V5002*	2"	78.18
CTC-7J1309	2-1/2"	120.71
CTC-5P7802	2-3/4"	141.73
CTC-7J3216	2-3/4"	141.73
CTC-5J6424	3"	212.60
CTC-5P7487	3-1/2"	377.19

* Sealed



REPLACEMENT PARTS FOR CATERPILLAR® EQUIPMENT

NOTE: Caterpillar® part numbers are used as a reference only. We do not imply that these kits are original REPLACEMENT PARTS.

WIPERS

Part Number	Rod Dia.	List Price
CTC-5M6708	0.6	\$ 2.70
CTC-352379	7/8	2.78
CTC-6J1879	3/4	2.27
CTC-5J2274	5/8	2.27
CTC-6J2274	5/8	2.27
CTC-3E4124	1	2.84
CTC-6J1890	1	2.27
CTC-3E4138	1-1/8	2.27
CTC-3E4125	1-1/4	3.16
CTC-3E4139	1-1/4	2.47
CTC-3E4160	1-1/4	11.02
CTC-4J8982	1-1/4	12.75
CTC-3E4140	1-3/8	2.64
CTC-3E4159	1-3/8	11.15
CTC-3E4161	1-1/2	11.25
CTC-4J8979	1-1/2	11.75
CTC-5J6795	1-1/2	2.90
CTC-8C9131	1-1/2	23.76
CTC-3E4103	1-1/2	1.66
CTC-3E4126	1-1/2	3.63
CTC-3E4141	1-1/2	2.90
CTC-4T0486	1-5/8	11.91
CTC-3E4104	1-5/8	1.75
CTC-1506739	1-3/4	24.20
CTC-3E4105	1-3/4	1.75
CTC-3E4162	1-3/4	12.17
CTC-4J8980	1-3/4	12.38
CTC-7J6932	1-3/4	12.17
CTC-7K9202	1-3/4	12.17
CTC-8C9132	1-3/4	24.20
CTC-1672452	1-3/4	24.20
CTC-3E4127	1-3/4	3.86
CTC-3E4142	1-3/4	3.25
CTC-3E4150	1-3/4	4.05
CTC-3G4721	1-7/8	3.36
CTC-3P1347	1-7/8	12.45
CTC-4T6777	1-7/8	11.90
CTC-1672457	2	25.37
CTC-1K6981	2	15.94
CTC-3E4106	2	1.78
CTC-3E4128	2	4.41
CTC-3E4143	2	3.40
CTC-3E4151	2	4.61
CTC-3E4164	2	12.63
CTC-4T0415	2	3.40

WIPERS

Part Number	Rod Dia.	List Price
CTC-5U3693	2	\$ 3.40
CTC-7K9203	2	14.03
CTC-8C9133	2	25.37
CTC-4T6125	2-1/8	9.23
CTC-3P1345	2-3/16	16.57
CTC-3E4107	2-1/4	1.91
CTC-4J3515	2-1/4	14.13
CTC-6J0217	2-1/4	3.59
CTC-7K9204	2-1/4	13.51
CTC-8C9134	2-1/4	26.43
CTC-3E4129	2-1/4	4.63
CTC-3E4144	2-1/4	3.59
CTC-3E4152	2-1/4	4.85
CTC-3E4165	2-1/4	13.51
CTC-3P1461	2-3/8	11.59
CTC-5J8016	2-3/8	3.78
CTC-6J3892	2-3/8	11.67
CTC-1K6982	2-1/2	15.54
CTC-3E4130	2-1/2	4.88
CTC-3E4153	2-1/2	5.11
CTC-5J8156	2-1/2	4.03
CTC-7K9205	2-1/2	15.29
CTC-8C3840	2-1/2	28.47
CTC-3E4108	2-1/2	2.14
CTC-3E4145	2-1/2	3.59
CTC-3E4166	2-1/2	15.29
CTC-3E4131	2-5/8	5.19
CTC-3G4719	2-5/8	4.03
CTC-7K9207	2-5/8	15.54
CTC-1J3540	2-3/4	18.86
CTC-5J7036	2-3/4	4.13
CTC-7K9208	2-3/4	17.32
CTC-7U4137	2-3/4	4.13
CTC-8C3842	2-3/4	30.16
CTC-9D6588	2-3/4	17.32
CTC-1672467	2-3/4	30.16
CTC-3E4109	2-3/4	2.26
CTC-3E4132	2-3/4	5.58
CTC-3E4169	2-3/4	4.13
CTC-2J1411	3	20.67
CTC-3E4110	3	2.64
CTC-3E4133	3	6.27
CTC-3E4146	3	4.33
CTC-3E4154	3	6.55
CTC-3E4170	3	17.80

WIPERS

Part Number	Rod Dia.	List Price
CTC-5J7030	3	\$ 4.30
CTC-5P4061	3	15.90
CTC-7K9209	3	8.18
CTC-8C5218	3	31.16
CTC-9D6589	3	17.80
CTC-5P4196	3-1/8	15.87
CTC-3E4173	3-1/4	17.23
CTC-5J7034	3-1/4	4.78
CTC-6J4169	3-1/4	21.10
CTC-7K9211	3-1/4	17.32
CTC-8T8389	3-1/4	32.04
CTC-1433672	3-1/2	32.84
CTC-1672474	3-1/2	32.84
CTC-3E4147	3-1/2	4.92
CTC-4J8981	3-1/2	9.94
CTC-5J7032	3-1/2	4.92
CTC-7K9212	3-1/2	23.75
CTC-7K9213	3-1/2	21.01
CTC-8C5219	3-1/2	32.84
CTC-8C5219	3-1/2	32.84
CTC-9D6591	3-1/2	17.32
CTC-3E4112	3-1/2	3.18
CTC-3E4134	3-1/2	7.43
CTC-3E4155	3-1/2	7.76
CTC-5U3529	3-1/2	4.92
CTC-3G5052	3-3/8	13.76
CTC-5P1177	3-3/8	13.76
CTC-3E4111	3-3/8	3.14
CTC-3E4113	3-3/4	3.37
CTC-4T5540	3-3/4	5.71
CTC-5P5322	3-3/4	28.59
CTC-7K9214	3-3/4	28.59
CTC-8C9135	3-3/4	33.42
CTC-8J6069	3-3/4	21.07
CTC-1389739	4	6.42
CTC-1672482	4	33.65
CTC-3E4114	4	3.54
CTC-3E4135	4	9.69
CTC-3E4148	4	6.42
CTC-3E4156	4	8.58
CTC-3E4177	4	33.46
CTC-5J2221	4	6.42
CTC-7J5673	4	27.03
CTC-8C5220	4	33.65
CTC-3E4115	4-1/4	3.74

NORTH AMERICA
PHONE 1-800-777-5617
FAX 1-800-759-6391

SALES OFFICE HOURS
8 A.M. TO 8 P.M. EASTERN TIME
www.HerculesUS.com

WORLDWIDE
PHONE 1-727-796-1300
FAX 1-727-797-8849

REPLACEMENT PARTS FOR CATERPILLAR® EQUIPMENT

NOTE: Caterpillar® part numbers are used as a reference only. We do not imply that these kits are original REPLACEMENT PARTS.

WIPERS

Part Number	Rod Dia.	List Price
CTC-4T1637	4-1/4	\$ 6.62
CTC-5P3193	4-1/4	27.61
CTC-7J8942	4-1/4	34.67
CTC-3G5053	4-3/8	41.06
CTC-5P1176	4-3/8	41.06
CTC-3E4116	4-1/2	3.84
CTC-3E4136	4-1/2	11.29
CTC-3G8505	4-1/2	7.19
CTC-3J4458	4-1/2	46.36
CTC-7K9218	4-1/2	17.82
CTC-3E4157	4-1/2	9.53
CTC-3E4117	4-3/4	3.98
CTC-7J9256	4-3/4	37.81
CTC-0903016	5	22.01
CTC-3E4118	5	4.72
CTC-3E4137	5	12.64
CTC-3E4149	5	10.03
CTC-3E4158	5	11.28
CTC-7K9220	5	36.92
CTC-8J4520	5	39.03
CTC-9J2547	5	10.03
CTC-9X3582	5	56.68
CTC-4T5663	5-1/4	12.39
CTC-3E4119	5-1/4	4.78
CTC-6J3073	5-1/2	43.42
CTC-9J5469	5-3/4	32.91

WIPERS

Part Number	Rod Dia.	List Price
CTC-3E4120	5-3/4	\$ 5.72
CTC-1U2708	6	14.76
CTC-3E4121	6	5.99
CTC-3J7622	6	68.27
CTC-3E4122	6-1/2	6.32
CTC-5P2322	6-1/2	52.75
CTC-6J0542	6-1/2	89.23
CTC-7J2806	6-1/2	52.75
CTC-8C9146	6-3/4	67.07
CTC-3E4123	6-3/4	6.44
CTC-2J4779	7	119.60
CTC-5J2682	7	50.88
CTC-8C9136	7	70.03
CTC-9X7366	7	50.88
CTC-7J3320	7-1/2	124.86
CTC-8J9934	8-1/2	21.39
CTC-6J7694	9	23.95
CTC-1U4625	11	33.38
CTC-9X7368	11	33.38
CTC-4T4130	12-1/2	171.71
CTC-9X7369	12-1/2	171.71
CTC-6R8716	40 mm	3.52
CTC-0957101	50 mm	21.30
CTC-0996995	55 mm	24.35
CTC-1163392	55 mm	24.35
CTC-0931433	60 mm	6.55

WIPERS

Part Number	Rod Dia.	List Price
CTC-1163391	60 mm	\$ 26.38
CTC-1163390	65 mm	27.98
CTC-0931434	70 mm	8.29
CTC-1163389	70 mm	30.02
CTC-1163388	75 mm	32.28
CTC-A04501419	75 mm	32.28
CTC-0931379	80 mm	13.13
CTC-1163387	80 mm	38.06
CTC-1140644	85 mm	43.20
CTC-7Y5115	85 mm	43.20
CTC-0931441	90 mm	46.70
CTC-1163386	90 mm	46.70
CTC-7X4803	90 mm	30.59
CTC-7Y4626	95 mm	30.70
CTC-0960059	100 mm	49.04
CTC-1076254	100 mm	49.04
CTC-1140646	100 mm	49.04
CTC-1140647	105 mm	47.38
CTC-1659290	105 mm	47.38
CTC-1119957	110 mm	50.23
CTC-7Y4940	110 mm	50.23
CTC-A04903618	110 mm	50.23
CTC-1119958	130 mm	60.16
CTC-1076615	140 mm	61.63
CTC-1076616	150 mm	64.63

CATERPILLAR®



REPLACEMENT PARTS FOR CATERPILLAR® EQUIPMENT

U-SEALS

Part Number	Rod Dia.	List Price
CTC-352380	7/8	\$ 6.52
CTC-6J1889	1	4.18
CTC-5J8150	1-1/2	9.21
CTC-9J4038	1-1/2	12.88
CTC-1672300	1-3/4	7.04
CTC-5J8175	1-3/4	10.52
CTC-4T6898	1-7/8	22.22
CTC-1672304	2	9.46
CTC-3G3259	2	16.98
CTC-3G3260	2	13.11
CTC-5J8200	2	13.11
CTC-5U3644	2	7.67
CTC-9J1318	2	16.98
CTC-4T6126	2-1/8	19.16
CTC-5J8225	2-1/4	13.95
CTC-7J4820	2-1/4	19.11
CTC-0917173	2-3/8	14.20
CTC-3G2911	2-3/8	40.00
CTC-5J8238	2-3/8	13.27
CTC-3G3752	2-1/2	36.76
CTC-3G3809	2-1/2	36.76
CTC-5J0964	2-1/2	13.59
CTC-7J4824	2-1/2	36.76
CTC-9X7257	2-1/2	36.76

U-SEALS

Part Number	Rod Dia.	List Price
CTC-3G4718	2-5/8	\$ 13.87
CTC-1672317	2-3/4	12.34
CTC-5J8275	2-3/4	13.87
CTC-9J2944	2-3/4	22.92
CTC-1P4879	3	33.40
CTC-5J8300	3	14.31
CTC-5J8325	3-1/4	15.10
CTC-7J2145	3-1/4	26.53
CTC-3G5051	3-3/8	15.10
CTC-5P1140	3-3/8	11.52
CTC-1049658	3-1/2	15.77
CTC-1672324	3-1/2	16.82
CTC-1P4880	3-1/2	20.35
CTC-5J8350	3-1/2	15.77
CTC-7J2150	3-1/2	28.58
CTC-5J8375	3-3/4	18.51
CTC-2U9113	4	20.25
CTC-5J8400	4	24.25
CTC-6J1425	4-1/4	24.57
CTC-9J1336	4-1/4	24.57
CTC-6J1450	4-1/2	27.95
CTC-9J1340	4-1/2	27.95
CTC-6J1475	4-3/4	32.36
CTC-9J1344	4-3/4	32.36

U-SEALS

Part Number	Rod Dia.	List Price
CTC-2U5379	5	\$ 20.42
CTC-3G5056	5	24.85
CTC-5P1139	5	24.85
CTC-6K2430	5	36.26
CTC-8J4524	5	49.51
CTC-3G2286	5-3/4	57.46
CTC-9J5467	5-3/4	52.40
CTC-9J5470	5-3/4	52.40
CTC-6J1650	6-1/2	60.10
CTC-8J1880	6-1/2	60.10
CTC-8J4387	6-1/2	72.08
CTC-6R8715	40 mm	9.80
CTC-A04600915	70 mm	16.57
CTC-A04600918	75 mm	20.16
CTC-A04600917	80 mm	22.05
CTC-0961567	85 mm	22.49
CTC-7Y5117	85 mm	24.03
CTC-0961587	90 mm	25.49
CTC-1672325	90 mm	16.83
CTC-7Y4629	95 mm	26.68
CTC-1505826	95 mm	18.01
CTC-0962664	100 mm	20.39
CTC-1076256	100 mm	29.18
CTC-7Y4670	105 mm	33.39

CATERPILLAR®

REPLACEMENT PARTS FOR CATERPILLAR® EQUIPMENT

NOTE: Caterpillar® part numbers are used as a reference only. We do not imply that these kits are original REPLACEMENT PARTS.

NON-CATERPILLAR U-SEALS

Part Number	Rod Dia.	List Price
CTC-3E4244	1	\$ 3.12
CTC-3E4245	1-1/8	4.16
CTC-3E4175	1-1/8	5.05
CTC-3E4284	1-1/8	5.63
CTC-3E4246	1-1/4	3.44
CTC-3E4181	1-1/4	5.17
CTC-3E4193	1-1/4	5.65
CTC-3E4182	1-3/8	5.48
CTC-3E4194	1-3/8	5.83
CTC-3E4247	1-1/2	3.59
CTC-3E4183	1-1/2	5.57
CTC-3E4195	1-1/2	6.41
CTC-3E4215	1-1/2	7.78
CTC-3E4184	1-5/8	5.93
CTC-3E4248	1-5/8	3.65
CTC-3E4216	1-3/4	8.65
CTC-3E4249	1-3/4	3.74
CTC-3E4287	1-3/4	7.01
CTC-3E4250	2	3.88
CTC-3E4186	2	7.00
CTC-3E4196	2	7.67
CTC-3E4217	2	9.24
CTC-3E4227	2	13.06
CTC-3E4251	2-1/4	4.04
CTC-3E4187	2-1/4	7.83
CTC-3E4197	2-1/4	8.62
CTC-3E4218	2-1/4	10.95
CTC-3E4228	2-1/4	14.56
CTC-3E4188	2-3/8	8.49
CTC-3E4252	2-1/2	4.08
CTC-3E4189	2-1/2	8.43
CTC-3E4198	2-1/2	9.48
CTC-3E4219	2-1/2	11.04
CTC-3E4229	2-1/2	15.32
CTC-3E4253	2-3/4	4.12
CTC-3E4199	2-3/4	10.35
CTC-3E4220	2-3/4	12.00
CTC-3E4230	2-3/4	17.49
CTC-3E4254	3	4.24
CTC-3E4190	3	10.19
CTC-3E4200	3	11.18
CTC-3E4221	3	12.96
CTC-3E4231	3	18.20
CTC-3E4255	3-1/4	4.30
CTC-3E4256	3-1/2	4.43

NON-CATERPILLAR U-SEALS

Part Number	Rod Dia.	List Price
CTC-3E4191	3-1/2	\$ 12.15
CTC-3E4202	3-1/2	12.90
CTC-3E4232	3-1/2	20.69
CTC-3E4192	3-3/4	14.20
CTC-3E4203	3-3/4	13.65
CTC-3E4225	4	17.03
CTC-3E4233	4	23.36
CTC-3E4205	4-1/4	17.78
CTC-3E4234	4-1/2	25.67
CTC-3E4235	5	28.12
CTC-3E4236	5-1/2	30.44
CTC-3E4237	6	32.57
CTC-3E4238	6-1/2	34.53
CTC-3E4240	7-1/2	43.18

ROD VEE SETS

Part Number	Rod Dia.	List Price
CTC-1J0132	1-1/4	\$ 5.94
CTC-1K7110	1-1/4	5.94
CTC-3D1123	1-1/2	9.92
CTC-1K7112	2	11.83
CTC-3F9609	2	12.73
CTC-2K4434	2-1/4	13.55
CTC-1K7114	2-1/2	18.01
CTC-4F8420	2-1/2	15.75
CTC-4J5830	2-1/2	15.75
CTC-5F3498	2-3/4	31.43
CTC-2J1408	3	20.79
CTC-2K1516	3	31.41
CTC-4J6897	3-1/4	24.81
CTC-1J2148	3-1/2	26.18
CTC-8M3912	3-1/2	13.33
CTC-2K0050	4	41.68
CTC-2K1335	4-1/2	35.60
CTC-3J7768	7-1/4	79.21

RECTANGULAR ROD SEALS

Part Number	Rod Dia.	Desc.	List Price
CTC-8C9139	2-1/2	Seal	\$ 18.07
CTC-8C9140	2-1/2	Back-up Ring	7.62
CTC-5J1731	7	Seal	15.30
CTC-5J5150	7	Back-up Ring	11.31
CTC-8T3539	7	Seal	11.31
CTC-8T3540	7	Back-up Ring	17.52
CTC-6J7693	9	Seal	22.20
CTC-8T3541	9	Seal	11.31
CTC-8T3542	9	Back-up Ring	20.75
CTC-9J4753	9	Back-up Ring	11.31

CUSHION SEALS

Part Number	Rod Dia.	List Price
CTC-1913128	110 mm	\$ 25.76
CTC-2316843	115 mm	29.08

DYR STYLE BUFFER RINGS

Part Number	Rod Dia.	List Price
CTC-1672186	1-1/2	\$ 2.44
CTC-1672192	1-7/8	3.32
CTC-1672198	2-1/8	3.82
CTC-1672200	2-1/4	4.16
CTC-1672201	2-1/2	4.73
CTC-1672202	2-3/8	4.67
CTC-1672208	3	6.34
CTC-1672209	3-1/4	6.67
CTC-1672214	3-3/4	8.33

CATERPILLAR®

REPLACEMENT PARTS FOR CATERPILLAR® EQUIPMENT

NOTE: Caterpillar® part numbers are used as a reference only. We do not imply that these kits are original REPLACEMENT PARTS.

1 PIECE BUFFER RINGS

Part Number	Rod Dia.	List Price
CTC-5P4673	7/8	\$ 3.69
CTC-9J3497	1-1/4	3.87
CTC-6J9733	1-1/2	4.86
CTC-6J9178	1-3/4	4.68
CTC-4T6778	1-7/8	11.65
CTC-9X3566	1-7/8	13.38
CTC-6J6917	2	5.68
CTC-4T6127	2-1/8	5.90
CTC-9X3568	2-1/8	16.61
CTC-5J3616	2-1/4	5.90
CTC-6J6916	2-3/8	6.28
CTC-5J3620	2-1/2	6.44
CTC-1U4020	2-5/8	7.47
CTC-9T9363	2-5/8	20.07
CTC-6J6553	2-3/4	6.84
CTC-6J6915	3	7.19
CTC-6J7167	3-1/4	7.71
CTC-6J6736	3-1/2	9.75
CTC-8J6070	3-3/4	10.44
CTC-8J4627	4	16.80
CTC-7J8943	4-1/4	8.89
CTC-3G5055	4-3/8	7.95
CTC-7J9257	4-3/4	13.68
CTC-8J4509	5	14.89
CTC-9J5468	5-3/4	17.44
CTC-6J8631	6-1/2	18.31
CTC-9J2495	7	19.00
CTC-A04600811	65 mm	9.60
CTC-7Y4630	95 mm	45.26

2 PIECE BUFFER RINGS

Part Number	Rod Dia.	List Price
CTC-8C9122	1-1/2	\$ 11.51
CTC-1672190	1-3/4	2.99
CTC-8C9123	1-3/4	12.27
CTC-1672195	2	3.47
CTC-8C9124	2	13.42
CTC-8C9125	2-1/4	17.30
CTC-8C9138	2-3/8	19.26
CTC-8C3839	2-1/2	16.01
CTC-1672207	2-3/4	6.18
CTC-8C3841	2-3/4	20.41
CTC-8C9126	3	19.05
CTC-8C9121	3-1/4	20.33
CTC-1672211	3-1/2	7.21
CTC-8C9127	3-1/2	24.58
CTC-8C9128	3-3/4	26.06
CTC-1672216	4	9.76
CTC-8C9129	4	27.48
CTC-6E0425	4-1/4	46.75
CTC-9X7261	4-3/4	48.65
CTC-9X3581	5	49.43
CTC-9X7267	5-1/4	50.95
CTC-9X3575	5-3/4	54.61
CTC-8C9130	7	68.60
CTC-0931481	60 mm	22.66
CTC-0931482	65 mm	26.94
CTC-A04601014	65 mm	26.94
CTC-0931483	70 mm	29.40
CTC-A04601015	70 mm	29.40
CTC-0963469	75 mm	31.25
CTC-A04601016	75 mm	31.25
CTC-0931484	80 mm	33.10
CTC-A04601017	80 mm	33.10
CTC-7Y5118	85 mm	35.52
CTC-0961585	90 mm	42.87
CTC-0962663	100 mm	46.57
CTC-1231942	105 mm	48.26
CTC-7Y4943	110 mm	50.24
CTC-A04601018	110 mm	50.24

3 PIECE BUFFER RINGS

Part Number	Rod Dia.	List Price
CTC-4I3611	85 mm	\$ 41.99

2 PIECE PISTON SEALS

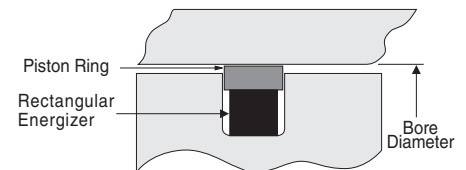

Part Number	Bore Dia.	List Price
CTC-5J7004A	2	\$ 8.60
CTC-1U3998A	2-1/4	10.89
CTC-8J6213A	2-1/2	10.24
CTC-5J7010A	2-3/4	15.64
CTC-6J1972A	3	11.51
CTC-6J0793A	3-1/4	16.35
CTC-5J7013A	3-1/2	14.32
CTC-5J8011A	3-3/4	20.81
CTC-5J5402A	4	16.18
CTC-5J7854A	4-1/4	17.48
CTC-5J4986A	4-1/2	20.19
CTC-5J4987A	4-3/4	22.07
CTC-5J5020A	5	23.91
CTC-5J7234A	5-1/4	28.51
CTC-5J4988A	5-1/2	28.25
CTC-9J4981A	5-3/4	39.66
CTC-5J4989A	6	27.02
CTC-5J4990A	6-1/4	27.61
CTC-5J4991A	6-1/2	31.01
CTC-5J4997A	7	33.62
CTC-5J4993A	7-1/4	30.19
CTC-9J7117A	7-1/2	63.06
CTC-5J7016A	7-3/4	79.98
CTC-5J5559A	8-1/4	38.19
CTC-6J9385A	8-1/2	42.40
CTC-5J7019A	9-1/4	47.70
CTC-1200890	75 mm	16.48

REPLACEMENT PARTS FOR CATERPILLAR® EQUIPMENT

NOTE: Caterpillar® part numbers are used as a reference only. We do not imply that these kits are original REPLACEMENT PARTS.

2 PIECE STEP-CUT PISTON SEALS

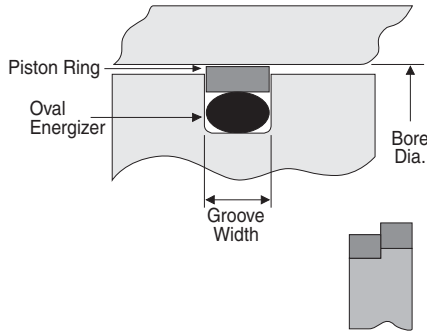

Part Number	Bore Dia.	Groove Width	List Price
CTC-1665295	2-3/4	0.19	\$ 26.52
CTC-4T8054	3-1/2	0.19	31.55
CTC-8C9160	4	0.25	36.66
CTC-9X7269	4-1/2	0.25	55.46
CTC-9X7264	5	0.38	44.66
CTC-8T0763	5-1/4	0.38	36.43
CTC-6E0465	5-1/2	0.38	55.83
CTC-4T5173	5-1/2	0.63	34.19
CTC-4T4144	6	0.63	37.89
CTC-4T8695	6-1/2	0.63	39.57
CTC-8T1789	7	0.63	32.69
CTC-8T1792	7-3/4	0.63	38.92
CTC-9T0119	8-1/2	0.63	59.62
CTC-8T1793	8-1/4	0.63	58.83
CTC-8T1794	10	0.69	95.45
CTC-8T1795	10-1/4	.069	98.01
CTC-8T1796	10-1/2	0.69	99.62
CTC-8T1797	11-1/2	0.69	125.57
CTC-1846970	75 mm		50.10
CTC-1841687	85 mm		27.67
CTC-9X7298	100 mm	7.24 mm	76.11
CTC-9X7301	110 mm	7.24 mm	90.34
CTC-9X3589	115 mm	7.24 mm	35.57
CTC-9X3592	120 mm	7.24 mm	90.34
CTC-9X3595	130 mm	7.24 mm	90.34
CTC-2371934	135 mm	7.24 mm	88.45
CTC-9X3598	140 mm	9.63 mm	82.27
CTC-9X3601	150 mm	9.63 mm	81.76
CTC-9X3604	160 mm	9.63 mm	81.76
CTC-9X3607	170 mm	9.63 mm	88.03
CTC-9X3610	180 mm	9.63 mm	88.01

5 PIECE PISTON SEALS

Part Number	Bore Dia.	List Price
CTC-931488	90 mm	\$ 88.54
CTC-A04601215	110 mm	113.81
CTC-A04601216	120 mm	113.81

CAPPED PISTON T-SEALS

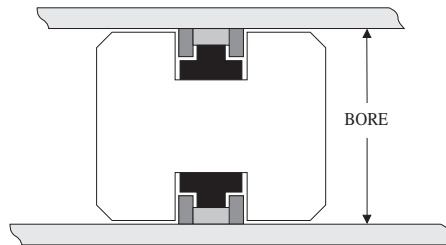

Part Number	Bore Dia.	List Price
CTC-8J3747	4-1/2	\$ 64.35
CTC-9J7868	5	78.63
CTC-8J8767	5-1/2	88.22
CTC-9J1242	6	92.18
CTC-9J5558	6-1/4	94.15
CTC-8J8703	6-1/2	103.88
CTC-8J3749	7	107.11
CTC-8J4510	7-1/4	110.59
CTC-9J5567	7-1/2	112.14
CTC-8J5644	7-3/4	116.84
CTC-8J4390	8-1/4	124.64
CTC-3G4762	8-1/2	130.74
CTC-9J3406	10	155.10
CTC-3G4765	10-1/2	167.51
CTC-9J2987	11-1/2	190.67
CTC-0996998	80 mm	39.69
CTC-0996973	90 mm	44.72
CTC-5I5928	100 mm	48.30
CTC-0996922	110 mm	51.41
CTC-A04601713	110 mm	51.41
CTC-A04601719	160 mm	90.06

NON CATERPILLAR PISTON SEALS

Part Number	Bore Dia.	List Price
CTC-3E4244	1	\$ 3.12
CTC-3E4245	1-1/8	4.16
CTC-3E4246	1-1/4	3.44
CTC-3E4247	1-1/2	3.59
CTC-3E4248	1-5/8	3.65
CTC-3E4249	1-3/4	3.74
CTC-3E4250	2	3.88
CTC-3E4251	2-1/4	4.04
CTC-3E4252	2-1/2	4.08
CTC-3E4253	2-3/4	4.12
CTC-3E4254	3	4.24
CTC-3E4255	3-1/4	4.30
CTC-3E4256	3-1/2	4.43

OVERSIZED HEAD SEALS

Part Number	Bore Dia.	List Price
CTC-8T8373	4-3/4	\$ 11.16
CTC-8T8374	5	34.76
CTC-8T8376	5-1/2	44.99
CTC-8T8377	6	44.59
CTC-8T8379	6-1/2	45.91
CTC-8T8380	7	47.36
CTC-8T8381	7-1/4	22.79
CTC-8C4892	7-3/4	29.84
CTC-8T8382	8-1/4	18.75
CTC-8C4893	8-1/2	51.55

CATERPILLAR®



REPLACEMENT PARTS FOR CATERPILLAR® EQUIPMENT

NOTE: Caterpillar® part numbers are used as a reference only. We do not imply that these kits are original REPLACEMENT PARTS.

WEAR RINGS

Part Number	O.D. X Width	List Price
CTC-8C9120	1-5/8 X 13/16	\$ 8.91
CTC-4T6780	1-5/8 X .98	7.61
CTC-8T5443	1-5/8 X 1-1/4	16.01
CTC-4T6907	1-7/8 X .98	18.73
CTC-8T6441	2 X 1/4	16.76
CTC-8T6442	2 X .72	19.00
CTC-4T6779	2 X .98	24.98
CTC-4T5613	2-1/8 X 1	5.06
CTC-8T7030	2-1/8 X 1-1/4	23.92
CTC-8T6682	2-1/4 X .36	39.68
CTC-8T6681	2-1/4 X .72	39.10
CTC-7H2423	2-1/4 X 7/8	6.20
CTC-4T6128	2-1/4 X .98	21.88
CTC-8T4958	2-3/8 X 1	28.18
CTC-8T8204	2-3/8 X 1-3/16	25.18
CTC-8J6212	2-1/2 X 3/4	7.33
CTC-9X7260	2-1/2 X 1.246	13.77
CTC-009004097	2.51 X 3.11	31.83
CTC-8T0785	2-5/8 X .98	27.35
CTC-8T5668	2-5/8 X 1-1/4	31.34
CTC-8T8394	2-5/8 X 1-11/16	40.02
CTC-8T8365	2.7 X 2.28	60.07
CTC-8J0112	2-3/4 X 15/16	10.45
CTC-8T7372	2-3/4 X .97	11.35
CTC-8C9200	2-7/8 X 1	33.91
CTC-8C9114	2-7/8 X 1	33.91
CTC-6C2385	2-7/8 X 1-1/4	28.47
CTC-8T7849	2-7/8 X 1.57	39.63
CTC-8T7020	2-7/8 X 1-13/16	25.77
CTC-8T6743	2.95 X 1.96	50.46
CTC-6J5733	3 X .99	13.09
CTC-8T6443	3 X 1	12.17
CTC-4T7283	3 X 1.24	18.35
CTC-8C9161	3-1/8 X .97	12.07
CTC-9T0094	3-1/8 X 1.24	56.40
CTC-8T1714	3-1/8 X 1-9/16	62.51
CTC-8T7584	3-1/8 X 1-5/8	31.92
CTC-8C9153	3.20 X 1.17	42.79
CTC-8J2577	3-1/4 X 3/4	8.47
CTC-8J6371	3-1/4 X 1.11	14.14

WEAR RINGS

Part Number	O.D. X Width	List Price
CTC-8T6683	3-1/4 X 1-1/8	\$ 46.21
CTC-8T0777	3-3/8 X 1.74	56.84
CTC-8T4813	3.45 X 1-5/8	41.41
CTC-8T6745	3.45 X 1.96	46.85
CTC-8T6744	3.45 X 2.74	67.69
CTC-6H5496	3-1/2 X 7/8	8.40
CTC-5J3326	3-1/2 X 1-1/8	25.41
CTC-7J9885	3-1/2 X 1-1/8	11.29
CTC-4J3236	3-1/2 X 1-1/2	47.20
CTC-8C5245	3-5/8 X 1.05	38.34
CTC-8T3329	3-5/8 X 1.88	46.02
CTC-8C3829	3.7 X 1.76	75.76
CTC-1324907	3.7 X 1.88	68.02
CTC-8T6746	3.7 X 2.36	53.11
CTC-8J6245	3-3/4 X 1	12.23
CTC-5J8019	3-3/4 X 1.24	12.45
CTC-6J3075	3-3/4 X 1.99	33.52
CTC-8T7848	3-7/8 X 1.57	62.91
CTC-8T3330	3.95 X 2-7/16	77.74
CTC-5J7154	4 X 5/8	6.12
CTC-8H0214	4 X 7/8	8.57
CTC-6J2797	4 X .99	16.39
CTC-6U3246	4 X 1	4.76
CTC-1M1571	4 x 1-1/4	13.59
CTC-3G4723	4-1/8 X .42	14.65
CTC-8T7538	4.2 X 1.56	64.42
CTC-8T6747	4.2 X 2.55	54.24
CTC-1194760	4-1/4 X 1	10.59
CTC-6J7264	4-1/4 X 1	21.25
CTC-6J4003	4-1/4 X 1-1/4	11.64
CTC-5J8157	4-1/4 X 1.49	15.53
CTC-4T4753	4-1/4 X 1.88	22.47
CTC-7J3300	4.258 X 2.49	43.51
CTC-8T6748	4.45 X 2-3/8	60.61
CTC-5U3531	4-1/2 X 3/4	4.25
CTC-6H6270	4-1/2 X 7/8	10.05
CTC-4J4605	4-1/2 X 15/16	12.96
CTC-4J3745	4-1/2 X 1	12.37
CTC-6U4154	4-1/2 X 1	5.83
CTC-4J2630	4-1/2 X 1-1/2	18.24

WEAR RINGS

Part Number	O.D. X Width	List Price
CTC-4J2620	4-1/2 X 1-1/2	\$ 17.89
CTC-6J4175	4-1/2 X 1.86	29.60
CTC-4T8758	4-1/2 X 1.86	29.60
CTC-0901301	4-1/2 X 2.362	49.31
CTC-4T9248	4-3/4 X 1-1/4	17.40
CTC-4J3342	4-3/4 X 1-1/4	17.40
CTC-5J3326	4-3/4 X 1-1/4	25.41
CTC-1317184	4-3/4 X 1.64	31.87
CTC-3J7663	4-3/4 X 1.99	81.96
CTC-9J9792	4-3/4 X 3-1/2	50.94
CTC-4T6929	4-3/4 X 3-1/2	50.94
CTC-8T7850	4.950 X 1.96	76.46
CTC-4J4630	5 X 1-1/8	14.51
CTC-8M4226	5 X 1.24	31.55
CTC-4J3420	5 X 1.55	15.31
CTC-4T4752	5 X 1-3/4	18.52
CTC-8T3331	5.2 X 2-1/2	75.76
CTC-9J7978	5-1/4 X 3/4	20.48
CTC-2D0714	5-1/4 X 1.02	33.51
CTC-9J7978	5-1/4 X 1.49	20.48
CTC-9J3054	5-1/4 X 3.61	65.29
CTC-4T5718	5.45 X 2.49	76.90
CTC-5U4278	5-1/2 X 3/4	4.44
CTC-4J4606	5-1/2 X 1-1/4	17.62
CTC-3J9026	5-1/2 X 1-3/8	32.09
CTC-7J3303	5-1/2 X 1.61	40.82
CTC-9J7191	5-1/2 X 1.74	50.37
CTC-7J1731	5-1/2 X 1-3/4	21.99
CTC-4J3518	5-1/2 X 1.99	45.03
CTC-8C9112	5-1/2 X 1.99	45.03
CTC-8J1690	5-1/2 X 2.24	52.86
CTC-9J4164	5-3/4 X 1.62	65.71
CTC-6J3074	5-3/4 X 1.99	51.37
CTC-8J9917	5-3/4 X 2.36	70.36
CTC-8T7851	5.95 X 1.96	73.30
CTC-8T3332	5.95 X 3.61	114.69
CTC-3G6537	6 X 1.07	28.72
CTC-5J0014	6 X 1-1/4	22.77
CTC-1J0708	6 X 1-5/16	24.32
CTC-9J5860	6 X 1-1/2	26.91

NORTH AMERICA
PHONE 1-800-777-5617
FAX 1-800-759-6391

SALES OFFICE HOURS
8 A.M. TO 8 P.M. EASTERN TIME
www.HerculesUS.com

WORLDWIDE
PHONE 1-727-796-1300
FAX 1-727-797-8849

REPLACEMENT PARTS FOR CATERPILLAR® EQUIPMENT

NOTE: Caterpillar® part numbers are used as a reference only. We do not imply that these kits are original REPLACEMENT PARTS.

WEAR RINGS

Part Number	O.D. X Width	List Price
CTC-7J5326	6 X 1-3/4	\$ 41.05
CTC-4T6930	6 X 2.74	116.46
CTC-8J1746	6 X 2.74	116.46
CTC-8J1764	6 X 2.74	116.46
CTC-8J1714	6 X 2.86	87.78
CTC-5J3326	6-1/4 X 1.49	25.41
CTC-9J5550	6-1/4 X 1-3/4	42.42
CTC-4T9319	6-1/4 X 2.74	117.78
CTC-5J0058	6-1/2 X 1-1/4	23.30
CTC-3J9027	6-1/2 X 1.37	21.10
CTC-9T0096	6-1/2 X 1-1/2	21.20
CTC-3J9703	6-1/2 X 1-1/2	21.20
CTC-9J9806	6-1/2 X 1.74	42.22
CTC-7J1938	6-1/2 X 2	35.80
CTC-9J3055	6-1/2 X 2.74	117.78
CTC-7J9232	6-1/2 X 2.86	58.16
CTC-9J0811	6-1/2 X 3.485	113.53
CTC-7J8881	6-1/2 X 3.49	154.53
CTC-1915604	6-3/4 X 0.99	43.06
CTC-8M4228	7 X 1.485	18.88
CTC-3G5098	7 X 1.74	42.34
CTC-9J0711	7 X 1.99	44.01
CTC-3G3470	7 X 2.365	105.51
CTC-8J1662	7 X 3-1/8	74.26
CTC-8T6749	7.2 X 3.14	102.55
CTC-1J2674	7-1/4 X 1-3/8	46.45
CTC-3J7848	7-1/4 X 2	45.66
CTC-1U1734	7-1/4 X 3-1/16	127.44
CTC-8T7693	7-1/4 X 7.1	217.86
CTC-4J7663	7-1/4 X 7.10	217.86
CTC-8T1127	7-3/8 X 1.61	85.49
CTC-8J9936	7-1/2 X 2.36	67.65
CTC-9J5562	7-1/2 X 2-1/2	64.61
CTC-4T4811	7-1/2 X 2.95	171.58
CTC-9J5037	7-3/4 X 1.61	96.81
CTC-9J3624	7-3/4 X 1.99	49.10
CTC-7J9247	7-3/4 X 3-1/2	111.38
CTC-4T6932	7-3/4 X 4.49	218.53
CTC-3G4625	7-3/4 X 4.49	218.53
CTC-4J9047	8 X 5	104.45

WEAR RINGS

Part Number	O.D. X Width	List Price
CTC-2J0745	8-1/4 X 1-1/4	\$ 24.14
CTC-4J7376	8-1/4 X 1-1/2	31.55
CTC-3J8683	8-1/4 X 1-3/4	41.98
CTC-3G9882	8-1/4 X 1.99	104.81
CTC-8J8375	8-1/4 X 2-1/8	65.04
CTC-3J7632	8-1/4 X 2-1/4	69.54
CTC-7J3301	8-1/4 X 2.49	106.90
CTC-8J8826	8-1/4 X 2.74	86.22
CTC-9J8102	8-1/4 X 2.74	144.55
CTC-4T9320	8-1/4 X 3-1/2	145.60
CTC-9J3056	8-1/4 X 4.11	73.59
CTC-7J8064	8-1/2 X 2.36	94.06
CTC-9M1604	8-1/2 X 3	107.34
CTC-1J5281	9-1/4 X 1-3/4	38.48
CTC-7J2087	9-1/4 X 2-1/4	107.00
CTC-4T6097	9-1/2 X 1.93	146.20
CTC-9J3369	10 X 3-1/4	84.95
CTC-9J1159	10 1/2 X 2.74	144.14
CTC-8J8900	10-1/2 X 3-3/4	85.29
CTC-8J5980	10-1/2 X 4	127.97
CTC-9J2991	11-1/2 X 3-7/8	93.62
CTC-4T6096	12-1/4 X 4	149.81
CTC-8T1130	12-7/8 X 2.86	308.88
CTC-4T4827	12-7/8 X 12.18	710.66
CTC-4T4129	14-1/4 X 3.99	216.15
CTC-4T4825	15-1/8 X 7.71	992.48
CTC-0908007	55 X 7.9 mm	16.08
CTC-1057252	71.3 X 5.9 mm	27.97
CTC-1052630	81.3 X 5.9 mm	21.06
CTC-1057388	91.3 X 5.9 mm	8.07
CTC-1079306	105 x 15 mm	19.49
CTC-A04901911	110 X 30 mm	21.37
CTC-1704829	130 X 15 mm	25.84
CTC-7Y4636	130 X 40 mm	52.21
CTC-1076264	140 X 8 mm	25.63
CTC-1076263	140 X 9.5 mm	19.94
CTC-0961581	150 X 7.9 mm	52.40
CTC-1163589	150 X 45 mm	56.79
CTC-1850231	160 X 8.9 mm	8.74
CTC-1475787	180 X 8.9 mm	14.72
CTC-1704828	220 X 15 mm	38.77

SILICONE O-RINGS

Part Number	Min. Pkgs.	List Price
CTC-1M6036	2	\$ 5.30
CTC-1S0004	5	3.00
CTC-1S2174	5	2.30
CTC-1S7462	6	0.80
CTC-1S9799	6	1.56
CTC-2M2561	3	4.36
CTC-2P3538	5	3.53
CTC-2S2251	5	5.16
CTC-5H7153	4	2.72
CTC-5H8853	20	0.31
CTC-5M3038	5	2.97
CTC-6F0249	4	1.15
CTC-6L1648	4	3.29
CTC-6L1649	3	3.78
CTC-6L1650	3	3.53
CTC-6L1651	3	5.54
CTC-6L9284	3	3.65
CTC-8M1112	6	0.94
CTC-8M4389	5	0.92
CTC-8M4390	3	3.53
CTC-8M4395	3	2.41
CTC-8M4431	4	0.84

CATERPILLAR®



REPLACEMENT PARTS FOR CATERPILLAR® EQUIPMENT

NOTE: Caterpillar® part numbers are used as a reference only. We do not imply that these kits are original REPLACEMENT PARTS.

SILICONE O-RINGS

Part Number	Min. Pkgs.	List Price
CTC-8M4432	5	\$ 1.84
CTC-8M4435	5	1.38
CTC-8M4436	3	3.24
CTC-8M4437	10	0.77
CTC-8M4438	5	0.80
CTC-8M4443	3	2.92
CTC-8M4445	5	1.53
CTC-8M4446	5	1.63
CTC-8M4447	6	0.76
CTC-8M4448	5	0.82
CTC-8M4986	10	2.68
CTC-8M4987	10	2.31
CTC-8M4988	5	1.82
CTC-8M4989	2	4.00
CTC-8M4990	3	2.68
CTC-8M4991	3	4.19
CTC-8M4992	3	2.86
CTC-8M5010	3	3.39
CTC-8M5248	5	2.00
CTC-8M5249	5	2.46
CTC-8M5252	3	4.08
CTC-8M5253	8	0.51
CTC-8M5254	5	2.14
CTC-8M5260	8	0.49
CTC-8M5661	3	3.05
CTC-8M8157	5	0.71
CTC-8M8281	5	1.10
CTC-8M8282	6	0.79
CTC-8M8283	3	1.02
CTC-8M8515	5	1.61
CTC-9H6067	5	3.24
CTC-9M4218	2	4.13
CTC-9M4849	5	3.43
CTC-9M7002	3	4.76
CTC-9M7539	3	2.83
CTC-9M9647	3	4.98

O-RINGS

Part Number	Min. Pkgs.	List Price
CTC-0032770	1	\$ 2.62
CTC-0068352	10	0.67
CTC-0314392	5	1.52
CTC-0951625	2	3.57
CTC-0951626	2	3.70
CTC-0951627	2	3.77
CTC-0951631	2	5.09
CTC-0951632	2	5.30
CTC-0951633	2	5.42
CTC-0951635	2	6.48
CTC-0951671	5	5.31
CTC-0951673	5	1.50
CTC-0951674	5	6.38
CTC-0951675	5	1.94
CTC-0951676	5	2.02
CTC-0951710	5	1.27
CTC-0951713	5	5.31
CTC-0951716	5	6.38
CTC-0951717	5	1.94
CTC-0951718	5	2.02
CTC-0951719	5	6.91
CTC-0951721	2	7.68
CTC-1757896	20	0.50
CTC-1H5728	20	0.42
CTC-1H6227	10	0.67
CTC-1H7339	20	0.50
CTC-1H8128	20	0.60
CTC-1H8171	50	0.10
CTC-1H8278	5	2.23
CTC-1H9696	20	0.46
CTC-1J2176	5	2.28
CTC-1J2859	10	1.10
CTC-1J9671	50	0.15
CTC-1M9015	1	3.45
CTC-1S7408	10	1.10
CTC-1T0132	1	2.78
CTC-1U3174	1	3.06
CTC-2D0598	20	0.24
CTC-2D6533	1	3.61
CTC-2D8009	5	1.34

O-RINGS

Part Number	Min. Pkgs.	List Price
CTC-2D8363	1	\$ 11.12
CTC-2H2665	20	0.60
CTC-2H3927	20	0.28
CTC-2H3928	10	0.75
CTC-2H3931	20	0.55
CTC-2H3932	50	0.16
CTC-2H3933	20	0.62
CTC-2H3934	20	0.62
CTC-2H3935	10	1.17
CTC-2H4145	20	0.59
CTC-2H6184	20	0.52
CTC-2H6338	20	0.55
CTC-2H6340	1	4.34
CTC-2H9247	10	1.10
CTC-2K2939	5	1.84
CTC-2K4472	5	1.67
CTC-2K8257	5	1.44
CTC-2M0340	1	2.56
CTC-2M1309	1	4.84
CTC-2M4453	50	0.08
CTC-2M9780	50	0.17
CTC-2S4078	20	0.35
CTC-2S8439	5	1.34
CTC-2U5341	5	1.28
CTC-2U5343	5	1.50
CTC-304606	10	0.67
CTC-3D2824	50	0.47
CTC-3D2898	20	0.25
CTC-3D2992	50	0.10
CTC-3D4245	50	0.09
CTC-3D8241	1	11.14
CTC-3E6703	10	1.17
CTC-3F5792	10	1.10
CTC-3H0107	50	0.10
CTC-3H2652	20	0.50
CTC-3H3385	50	0.08
CTC-3J0634	5	2.06
CTC-3J1907	50	0.15
CTC-3J7354	50	0.15
CTC-3K0360	50	0.16

NORTH AMERICA
PHONE 1-800-777-5617
FAX 1-800-759-6391

SALES OFFICE HOURS
8 A.M. TO 8 P.M. EASTERN TIME
www.HerculesUS.com

WORLDWIDE
PHONE 1-727-796-1300
FAX 1-727-797-8849

REPLACEMENT PARTS FOR CATERPILLAR® EQUIPMENT

NOTE: Caterpillar® part numbers are used as a reference only. We do not imply that these kits are original REPLACEMENT PARTS.

O-RINGS		
Part Number	Min. Pkgs.	List Price
CTC-3P0651	1	\$ 3.84
CTC-3S1223	5	1.84
CTC-3S6538	20	0.28
CTC-4D1577	1	6.40
CTC-4D3107	20	0.20
CTC-4D4508	1	5.29
CTC-4D6695	1	4.45
CTC-4F5607	20	0.25
CTC-4F7387	10	1.10
CTC-4F7389	20	0.28
CTC-4F7390	20	0.47
CTC-4F7391	50	0.17
CTC-4F7952	20	0.22
CTC-4F8824	20	0.35
CTC-4F8946	50	0.16
CTC-4F9029	50	0.17
CTC-4F9653	20	0.39
CTC-4H6520	5	2.01
CTC-4H6730	1	9.73
CTC-4H9105	10	0.84
CTC-4J0519	20	0.26
CTC-4J0520	20	0.27
CTC-4J0521	20	0.29
CTC-4J0522	20	0.33
CTC-4J0523	20	0.40
CTC-4J0524	20	0.42
CTC-4J0525	20	0.43
CTC-4J0526	20	0.48
CTC-4J0527	20	0.50
CTC-4J0528	20	0.52
CTC-4J1253	1	6.68
CTC-4J5140	50	0.17
CTC-4J5267	50	0.19
CTC-4J5268	50	0.09
CTC-4J5351	50	0.09
CTC-4J5477	50	0.06
CTC-4J5573	20	0.38
CTC-4J7533	50	0.10
CTC-4J8996	50	0.18
CTC-4J8997	50	0.22

O-RINGS		
Part Number	Min. Pkgs.	List Price
CTC-4K1388	20	\$ 0.25
CTC-4K6804	1	2.56
CTC-4L9564	10	0.84
CTC-4M0189	10	0.72
CTC-4M0661	1	5.01
CTC-4M0737	1	5.29
CTC-4S5879	1	5.46
CTC-4S7762	1	5.15
CTC-4T4128	1	6.68
CTC-5F0149	10	0.97
CTC-5F1678	50	0.14
CTC-5F3092	10	0.72
CTC-5F3106	10	1.06
CTC-5F3144	10	1.00
CTC-5F3999	10	1.06
CTC-5F7054	50	0.09
CTC-5F8000	20	0.33
CTC-5F9657	20	0.20
CTC-5H3252	5	1.39
CTC-5H4909	1	2.78
CTC-5H5672	10	1.22
CTC-5H6733	5	1.81
CTC-5H6734	10	0.94
CTC-5H7370	20	0.25
CTC-5H8624	10	1.00
CTC-5H8848	20	0.45
CTC-5H9524	5	1.78
CTC-5J2974	50	0.09
CTC-5K1787	5	2.33
CTC-5K5959	20	0.42
CTC-5K9090	50	0.16
CTC-5L5032	5	2.23
CTC-5M5860	20	0.25
CTC-5M6200	1	7.79
CTC-5P1979	5	1.67
CTC-5P2235	1	3.45
CTC-5P2236	1	5.92
CTC-5P2568	20	0.24
CTC-5P4326	5	1.29
CTC-5P5756	3	6.27

O-RINGS		
Part Number	Min. Pkgs.	List Price
CTC-5P6302	10	\$ 0.89
CTC-5P7593	1	2.83
CTC-5S3676	1	2.78
CTC-6D9157	5	1.84
CTC-6F0711	20	0.25
CTC-6F4718	5	1.67
CTC-6F4855	50	0.07
CTC-6F6673	50	0.17
CTC-6F8146	20	0.55
CTC-6H3977	20	0.47
CTC-6J1038	50	0.16
CTC-6J2419	20	0.18
CTC-6J5541	5	2.07
CTC-6K6307	10	0.50
CTC-6K9149	5	3.34
CTC-6V1934	1	3.34
CTC-6V3263	1	5.01
CTC-6V8397	50	0.06
CTC-6V8398	50	0.07
CTC-6V8400	50	0.18
CTC-6V9746	50	0.10
CTC-7D1195	5	2.90
CTC-7F2122	10	0.67
CTC-7F8267	20	0.28
CTC-7H2444	10	0.75
CTC-7J0204	50	0.10
CTC-7J8956	5	2.01
CTC-7J9108	50	0.09
CTC-7M8485	20	0.27
CTC-7S8554	1	5.01
CTC-8B4967	50	0.20
CTC-8F4469	5	1.56
CTC-8F4994	50	0.20
CTC-8F5900	1	2.78
CTC-8F6230	1	2.78
CTC-8F6711	20	0.35
CTC-8F8230	1	2.78
CTC-8F8733	5	1.50
CTC-8F8861	1	4.17
CTC-8F8882	20	0.45

CATERPILLAR®



REPLACEMENT PARTS FOR CATERPILLAR® EQUIPMENT

NOTE: Caterpillar® part numbers are used as a reference only. We do not imply that these kits are original REPLACEMENT PARTS.

O-RINGS

Part Number	Min. Pkgs.	List Price
CTC-8F9206	50	\$ 0.07
CTC-8F9516	5	1.29
CTC-8F9960	1	6.90
CTC-8H0273	5	2.10
CTC-8H2046	10	0.89
CTC-8H7521	20	0.59
CTC-8J1665	5	2.14
CTC-8J1688	5	1.50
CTC-8J4386	1	3.53
CTC-8J8879	1	3.06
CTC-8L9241	1	3.50
CTC-8M8997	50	0.08
CTC-8P6357	1	13.84
CTC-8T0315	20	0.23
CTC-8T2360	3	2.40
CTC-8T2361	3	2.43
CTC-8T6404	5	1.67
CTC-9F1399	5	1.78
CTC-9F4446	10	0.75
CTC-9F7283	10	1.10
CTC-9H0846	1	9.73
CTC-9H4557	50	0.20
CTC-9J5686	20	0.54
CTC-9M2092	10	1.00
CTC-9M3786	5	1.72
CTC-9M5024	5	2.33
CTC-9M5894	1	2.60
CTC-9S3888	5	1.39
CTC-9X4611	10	0.91
CTC-Z440101000	2	3.77
CTC-Z440101100	2	4.90
CTC-Z440201000	2	4.90
CTC-Z440201400	2	5.42
CTC-Z441001100	5	6.38
CTC-Z441101050	5	1.95
CTC-Z441101150	5	2.02
CTC-Z441101600	2	7.13

BACK-UP RINGS

Part Number	Min. Pkgs.	List Price
CTC-0875391	1	\$ 8.35
CTC-0875436	1	6.49
CTC-0875510	1	6.24
CTC-0875550	1	7.43
CTC-0961588	1	9.91
CTC-0962665	1	11.54
CTC-0990660	1	5.04
CTC-0990699	1	8.09
CTC-0995399	1	5.83
CTC-0997000	1	5.98
CTC-1057360	1	6.12
CTC-1057375	1	6.24
CTC-1057393	1	4.91
CTC-1076255	1	11.54
CTC-1076258	1	28.50
CTC-1214160	1	9.56
CTC-1220440	1	11.28
CTC-1400233	3	3.08
CTC-1K7095	4	2.06
CTC-1K7098	5	1.68
CTC-1S0668	6	1.16
CTC-1S0669	5	1.35
CTC-1S0670	8	0.88
CTC-1U1101	2	6.17
CTC-1U1626	1	5.41
CTC-1U1738	2	4.12
CTC-1U1770	2	4.63
CTC-1U3173	2	4.45
CTC-1U3307	2	4.63
CTC-1U3383	1	26.39
CTC-2J0744	2	6.07
CTC-2J3961	3	2.35
CTC-2J4066	5	1.35
CTC-2J7767	3	2.71
CTC-2K2940	2	4.44
CTC-2K2961	3	3.08
CTC-2K3258	2	3.68
CTC-2K4096	3	2.49
CTC-2K4473	2	4.00
CTC-2K6830	5	1.68

BACK-UP RINGS

Part Number	Min. Pkgs.	List Price
CTC-2K8256	2	\$ 3.89
CTC-2Y8973	6	1.09
CTC-3C3239	10	0.94
CTC-3E6795	1	16.64
CTC-3G3747	2	4.12
CTC-3J2688	1	6.65
CTC-3J8466	1	6.50
CTC-3J9742	2	4.96
CTC-3K7219	9	0.81
CTC-3K7863	9	0.76
CTC-3K8692	9	0.81
CTC-3K8699	10	0.85
CTC-3P1204	8	0.88
CTC-3P1205	8	0.81
CTC-3P1206	5	1.56
CTC-3P1207	7	1.06
CTC-4I3627	1	6.68
CTC-4I6330	1	9.42
CTC-4J1151	1	6.83
CTC-4J6557	2	6.17
CTC-4J9218	2	4.36
CTC-4J9219	5	1.09
CTC-4J9220	5	1.68
CTC-4J9221	4	1.84
CTC-4J9223	2	4.00
CTC-4J9224	6	1.16
CTC-4J9225	7	1.06
CTC-4K4759	9	0.76
CTC-4T3107	2	4.64
CTC-4T5929	1	15.34
CTC-5J0604	2	3.52
CTC-5J0605	10	0.94
CTC-5J3934	5	1.32
CTC-5J6444	2	4.39
CTC-5J7865	5	1.68
CTC-5K7865	5	1.68
CTC-5P0909	3	3.08
CTC-5P0910	4	2.13
CTC-5P0911	6	1.28
CTC-5P2134	8	0.94

NORTH AMERICA
PHONE 1-800-777-5617
FAX 1-800-759-6391

SALES OFFICE HOURS
8 A.M. TO 8 P.M. EASTERN TIME
www.HerculesUS.com

WORLDWIDE
PHONE 1-727-796-1300
FAX 1-727-797-8849

REPLACEMENT PARTS FOR CATERPILLAR® EQUIPMENT

NOTE: Caterpillar® part numbers are used as a reference only. We do not imply that these kits are original REPLACEMENT PARTS.

BACK-UP RINGS

Part Number	Min. Pkgs.	List Price
CTC-5P2199	10	\$ 0.85
CTC-5P3235	2	4.64
CTC-5P7857	9	0.76
CTC-5P7858	9	0.76
CTC-5P8208	10	0.85
CTC-5P8921	4	2.27
CTC-5P9685	8	0.85
CTC-5P9686	8	0.94
CTC-5P9687	8	0.94
CTC-6J1021	10	0.94
CTC-6J1381	6	1.16
CTC-6J2418	8	0.94
CTC-6J2420	7	1.06
CTC-6J5731	7	1.06
CTC-6U3042	3	3.14
CTC-6U5640	3	1.63
CTC-6V1555	7	1.06
CTC-6V1556	8	0.88
CTC-6V1557	10	0.85
CTC-6V1558	7	1.06
CTC-6V1941	8	0.81
CTC-6V3299	8	0.94
CTC-6V3300	8	0.94
CTC-6V3580	1	11.28
CTC-6V3838	9	0.76
CTC-6V3956	9	0.76
CTC-7J6287	10	0.94
CTC-7J6288	8	0.85
CTC-7J8955	2	4.12
CTC-7X4757	2	4.63
CTC-7X4807	2	3.68
CTC-7Y4628	1	29.08
CTC-7Y4633	1	6.10
CTC-7Y4669	1	28.34
CTC-7Y4673	1	7.04
CTC-7Y4945	1	8.21
CTC-7Y5116	1	27.60
CTC-8J0548	2	4.12
CTC-8J1666	2	4.12
CTC-8J1689	3	2.90

BACK-UP RINGS

Part Number	Min. Pkgs.	List Price
CTC-8J1717	2	\$ 3.49
CTC-8J2574	6	1.16
CTC-8J3752	4	2.04
CTC-8J4385	2	4.12
CTC-8J8880	1	6.91
CTC-9J0240	9	0.76
CTC-9J0705	10	0.71
CTC-9J7861	3	2.42
CTC-9X4596	1	6.91
CTC-9X7273	2	4.12
CTC-9X7278	4	2.27
CTC-9X7279	3	2.42
CTC-A04700414	1	20.33
CTC-A04700712	1	5.04

D-RINGS

Part Number	I.D.	List Price
CTC-1P3700	19 mm	\$ 1.17
CTC-1P3702	25.4 mm	1.32
CTC-1P3703	31.9 mm	1.57
CTC-1P3704	38.2 mm	1.70
CTC-1P3705	44.7 mm	1.82
CTC-1P3706	51.1 mm	1.95
CTC-1P3707	54.2 mm	2.00
CTC-1P3708	57.4 mm	2.11
CTC-1P3709	63.9 mm	2.21

CATERPILLAR®

REPLACEMENT KITS FOR CATERPILLAR® EQUIPMENT

NOTE: Caterpillar® part numbers are used as a reference only. We do not imply that these kits are original REPLACEMENT PARTS.

CAT D-RING KIT

This handy kit, in an unbreakable box, contains the 9 most popular sized D-Rings used on Caterpillar® equipment.

Part Number: CTC-4C4784
List Price: \$ 134.81



CAT SILICONE O-RING KIT

This handy kit, in an unbreakable box, contains 149 silicone o-rings in the 32 most popular sizes used on Caterpillar® equipment

Part Number: CTC-4C8253
List Price: \$ 363.12



CAT KIT FACE KIT

This handy kit contains a total of 120 90 Durometer O-Rings in 8 different sizes.

Part Number: CTC-4C5859
List Price: \$ 67.78



CAT NITRILE O-RING KIT

This handy kit, in an unbreakable box, contains 570 nitrile o-rings in the 32 most popular sizes used on Caterpillar® equipment.

Part Number: CTC-4C4782
List Price: \$ 227.77



REPLACEMENT PARTS FOR CATERPILLAR® EQUIPMENT

NOTE: Caterpillar® part numbers are used as a reference only. We do not imply that these kits are original REPLACEMENT PARTS.

“NYLON INSERT” LOCKING NUTS

Manufactured from the finest quality steel and heat treated to offer superior strength, Hercules® Sealing Products locking nuts with nylon inserts are specifically designed and manufactured to exact dimensions. The high temperature locking inserts are designed to withstand the high temperatures associated with close tolerance performance applications.

Part Number	Thread Size & Pitch	Height	O.D.	List Price
CTC-2J0564	2 - 12	1-5/8	3-1/8	\$ 80.51
CTC-2J3247	1-3/4 - 12	1-7/16	2-3/4	55.85
CTC-2J3950	1-1/2 - 12	1-5/16	2-3/8	31.63
CTC-2J6384	1-1/4 - 12	1-1/8	2	28.19
CTC-2J7686	2-1/2 - 12	2-3/16	4	183.49
CTC-3J6899	2-1/4 - 12	2-13/16	3-1/2	184.90
CTC-3J9449	2-1/2 - 12	2-5/8	4	211.91
CTC-3J9545	2 - 12	2-7/16	3-1/8	131.79
CTC-4J6888	2-3/4 - 12	2-1/4	4	149.23
CTC-4J8734	2-3/4 - 12	3-1/8	4	256.11
CTC-5J3488	2-1/4 - 12	1-15/16	3-1/2	135.74
CTC-5J5731	1-3/4 - 12	1-7/16	2-1/2	37.77
CTC-7J9250	3-1/4 - 12	3-1/8	4-1/2	273.87
CTC-7Y4622	72 mm - 2		105 mm	356.55
CTC-7Y4695	80 mm - 2		115 mm	341.04
CTC-7Y4956	90 mm - 2		130 mm	408.38
CTC-9X6018	4.00 - 12		5.62	640.39
CTC-0875385	95 mm - 2		135 mm	508.61
CTC-1163513	105 mm - 2		150 mm	878.16
CTC-1163516	120 mm - 2		170 mm	971.40
CTC-1232060	80 mm - 2		115 mm	241.80
CTC-1232112	90 mm - 2		130 mm	427.96
CTC-1261971	100 mm - 2		146 mm	975.93

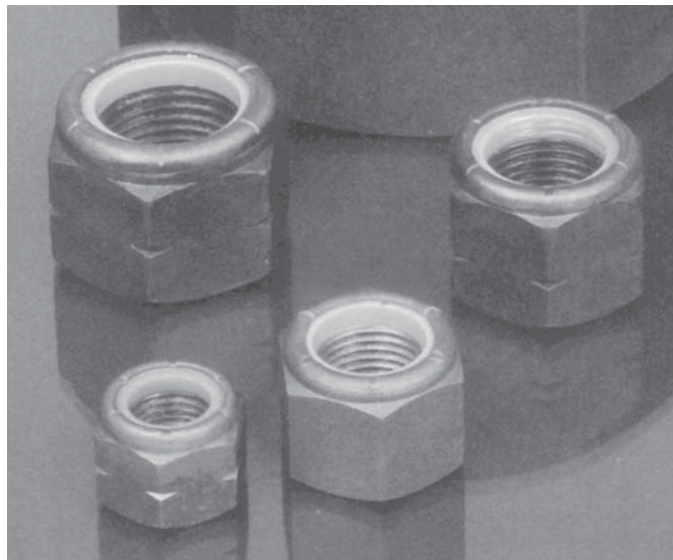

CATERPILLAR®



REPLACEMENT KITS FOR CATERPILLAR TOWMOTOR LIFT TRUCKS

NOTE: If you can locate the cylinder group number, it can aid in identifying the proper kit.

Kit Number	Code (Pg. xiv)	Rode X Bore Size	List Price	Kit Number	Code (Pg. xiv)	Rode X Bore Size	List Price
TM-1033947	I-U-10	40 X 90 mm	\$ 63.11	TM-396846	P-UB-10	2 X 4-1/2	\$ 77.71
TM-1040763	P-U-1	70 mm	49.59	TM-396847	I-V-8	2 X 4.525	50.58
TM-1040900	I-U-10	37 X 71 mm	34.01	TM-396848	P-UB-11	1-1/4 X 3	36.69
TM-1040948	P-U-1	35 mm	25.24	TM-396849	I-V-8	2 X 5.025	58.08
TM-1041095	P-U-1	40 x 50 mm	83.85	TM-659060	O-RINGS		6.17
TM-1042519	P-U-1	85 X 100 mm	59.03	TM-690003	I-U-5	2 X 5	89.13
TM-1042609	P-U-4	45 X 55 mm	63.14	TM-691389	I-OB-3	1-1/2 X 2-1/2	19.22
TM-1146727	P-U-14	50 X 110 mm	91.60	TM-693683	O-RINGS		7.39
TM-324908	I-V-8	2 X 4.525	55.13	TM-694526	I-UB-5	2 X 5	85.41
TM-324958	P-I-N-8	3 X 4.025	68.02	TM-694527	I-UB-5	2-1/2 X 6	94.43
TM-375427	I-U-11	1 X 2-1/2	14.98	TM-694528	I-U-4, 10	2 X 4-1/2	57.97
TM-376968	I-U-1	2-1/2 Rod	29.30	TM-695522	I-UB-5	1-1/4 X 3-1/2	61.32
TM-388594-6	P-UB-10	1-1/2 X 3-1/2	35.72	TM-695523	I-UB-5	1-1/2 X 4	73.21
TM-396743	I-P-N-8	3 X 4.025	79.10	TM-901523	I-U-1	2-1/2, 3-1/4, 4 Stages	134.01
TM-396744	I-U-8	2-1/2 X 3.525	35.48	TM-905761	P-U-1	3-1/8, 4-3/8 Stages	174.50
TM-396746	I-P-U-1	2-1/4, 3-1/4, 4-1/8 Stages	121.81	TM-905771	P-U-1	2-3/8, 4-3/8 Stages	141.32
TM-396747	P-U-8	3 X 3.525	48.74	TM-905961	VALVE KIT		9.96
TM-396748	I-U-8	3 X 4.025	45.02	TM-905962	VALVE KIT		4.67
TM-396749	P-U-1	3-1/8, 4-3/8, 5 Stages	207.03	TM-906496	I-U-10	3 X 4	47.63
TM-396750	P-U-1	2-3/16 X 2-1/2	41.70	TM-911700	I-U-1	75 mm Rod Kit	39.78
TM-396751	P-U-8	3-3/4 X 5.025	74.97	TM-911701	I-U-N	50 mm Rod Kit	42.30
TM-396752	I-U-8	2-5/8 X 3.025	53.79	TM-911725	I-O-10	25 X 50 mm	42.14
TM-396754	I-U-8	2-1/2 X 3.025	35.33	TM-911726	I-U-10	35 X 80 mm	51.01
TM-396755	I-U-8	3 X 3.525	42.86	TM-911956	P-U-1	1-5/8 Rod Kit	20.76
TM-396756	I-P-1-8	3 X 4.025	65.23	TM-912067	P-UB-10	1-1/4 X 3	27.40
TM-396757	P-U-1	2-3/8, 4-3/8, 5 Stages	193.20	TM-912711	P-U-1	2-3/8 Rod Kit	32.27
TM-396758	I-P-U-1	1-7/8, 2-3/4, 3-5/8 Stages	105.59	TM-912748	P-U-1	2-3/8 Rod Kit	32.36
TM-396759	I-V-1	2.700, 3.450, 5.700 Stgs.	132.40	TM-914206	P-UB-10	2 X 4-1/2	57.71
TM-396760	I-V-1	2.200, 2.950, 4.700 Stgs.	102.97	TM-914634	I-U-N	3-3/4" Rod	34.84
TM-396761	I-P-N-8	3 X 5.025	90.06	TM-914635	I-U-10	2 X 2-1/2	60.37
TM-396801	P-U-1	3-3/8, 4-3/8, 5 Stages	229.50	TM-914636	N-U-10	4 X 4-1/2	90.55
TM-396842	P-UB-10	1-1/2 X 3-1/2	34.56	TM-918024	P-U-4	150 X 180 mm	332.18
TM-396843	P-U-11	1-1/2 X 3-1/2	26.33	TM-919851	P-U-15	120 X 180 mm	600.54
TM-396844	P-UB-11	1-1/2 X 3-1/2	27.59	TM-920666	I-U-N	50 mm Rod Kit	34.60
TM-396845	I-U-11	1-1/4 X 3	20.56	TM-923282	I-U-10	2 X 2-1/2	95.64

CATERPILLAR®

REPLACEMENT PARTS FOR CATERPILLAR TOWMOTOR LIFT TRUCKS

Part Number	Type	O.D.	I.D.	Hgt.	List Price
TM-5461	Vee Set	1-1/4	1-3/4VS		\$ 7.37
TM-41248	Vee Set	2.200	2.700	1	16.81
TM-41250	Vee Set	2.950	3.450	1	19.17
TM-41252	Vee Set	4.700	5.290	1	32.79
TM-41340	Vee Set	4.025	5.025	1.3	39.61
TM-67841	Vee Set	2.700	3.450		21.90
TM-67842	Vee Set	3.450	4.250	1.5	39.59

Part Number	Type	O.D.	I.D.	Hgt.	List Price
TM-67843	Vee Set	5.700	6.450		\$ 43.21
TM-303231	Wiper	1	1-3/8	3/16	2.08
TM-303260	Vee Set	2.275	3.025	1.2	18.04
TM-371212	Modular Back-up Ring	5	5-3/4	.226	30.41
TM-903016	Wiper	5	5-3/4	3/8	22.01

CHAMPION MOTOR GRADER

Kit Number	Code (Pg. xiv)	Rode X Bore Size	List Price
CHMP-26408	1-3/8 X 3	I-U-5	\$ 37.96
CHMP-26409	2 X 4	I-U-5	54.74
CHMP-26410	2 X 5	I-U-5	74.04

CATERPILLAR® - CHAMPION



CHARLYNN SEAL KITS

Charlynn Model Identification

XXX - XXX - XXX
 Product - Product - Engineering
 Line Identification Change Code

Kit Number	Series	Description	Model Number	List Price
CHR-6405	10,000 Note: The -002 and -003 bearingless motors use 4 seals while the -004 motor uses 3 seals. Note: This kit is not applicable to 10,000 series two speed motors.	Motor Seal Kit	119-XXXX-002;-003;-004 120-XXXX-002;-003;-004 121-XXXX-002;-003;-004	\$ 71.73
CHR-6406	10,000 Note: Applicable to 10,000 series two speed motors.	Shaft Seal Kit	119-XXXX-001;-002;-003;-004 120-XXXX-002;-003;-004 121-XXXX-001;-002;-003;-004	77.23
CHR-60023	H A	Buna N Seal Kit Buna N Seal Kit	101-XXXX-007 130-XXXX-001	53.39
CHR-60026	S	Buna N Seal Kit	103-XXXX-007	55.04
CHR-60036	H	Buna N Seal Kit	101-XXXX-005	41.80
CHR-60042	S	Buna N Seal Kit	103-XXXX-006	55.34
CHR-60533	S	Buna N Seal Kit	103-XXXX-008	51.37
CHR-60539	S	Buna N Seal Kit	103-XXXX-009;-010	63.18
CHR-60540	A H	Buna N Seal Kit Buna N Seal Kit	130-XXXX-002;-003 101-XXXX-008;-009	63.18
CHR-61104	6000	Shaft Seal Kit	112-XXXX-002;-003;-004 113-XXXX-002;-003;-004	107.72
CHR-61105	6000	Rear Motor Kit	112-XXXX-002;-003;-004 113-XXXX-002;-003;-004	39.39
CHR-61234	4000	Rear Motor Kit	109-XXXX-004; 110-XXXX-004	36.63
CHR-61236	4000	Shaft Seal Kit	109-XXXX-004; 110-XXXX-004	57.71
CHR-61237	6000	Shaft Seal Kit	112-XXXX-005; 113-XXXX-005	58.42
CHR-61238	6000	Rear Motor Kit	112-XXXX-005; 113-XXXX-005	52.56
CHR-61252	2000 Note: Not for 106- Bearingless motors.	Buna N Seal Kit	104-XXXX-003;-004;-005 105-XXXX-003;-004;-005	83.07
CHR-61258	2000	Buna N Seal Kit	104-XXXX-006; 105-XXXX-006	83.44
CHR-61259	2000 Note: Does not fit 106-XXXX-003;-004;-005 motors	Buna N Seal Kit	106-XXXX-006	40.50
CHR-64417	Steering unit with external shaft			32.37
CHR-64418	Steering unit with internal spline			35.06
CHR-64468	25	Buna N Seal Kit	251-XXXX-001;252-XXXX-001;253-XXXX-001	76.11

CHIEF CYLINDERS

Kit Number	Code (Pg. xiv)	Rod X Bore Size	List Price
CTR-203-001	P-OB-3	1-1/8" x 2"	\$ 7.92
CTR-203-002	P-OB-3	1-1/8" x 2-1/2"	8.30
CTR-203-004	P-OB-3	1-1/4" x 3-1/2"	9.45
CTR-203-005	P-OB-3	1-1/2" x 3-1/2"	9.76
CTR-203-006	P-OB-3	1-1/4" x 4"	9.30
CTR-203-011	P-OB-3	1-1/4" x 2-3/8"	7.69
CTR-203-029	P-OB-3	1-1/2" x 3"	9.23
CTR-203-150	P-U-10	1" x 1-1/2"	12.08
CTR-203-151	P-U-10	1-1/4" x 2"	16.15
CTR-203-152	P-U-10	1-3/8" x 2-1/2"	17.81
CTR-203-153	P-U-10	1-1/2" x 3"	17.81
CTR-781-007	I-U-1	1-1/2" Rod Kit	13.60
CTR-781-008	I-U-1	1-3/4" Rod Kit	16.37
CTR-781-009	I-U-1	2" Rod Kit	18.07
CTR-781-013	I-U-1	1-3/4" Rod Kit	12.99
CTR-781-014	I-U-1	2" Rod Kit	19.64
CTR-781-015	I-U-1	2-1/4" Rod Kit	20.84
CTR-781-020	I-U-1	2" Rod Kit	20.69
CTR-781-021	I-U-1	2-1/2" Rod Kit	23.53
CTR-781-022	I-U-1	2-3/4" Rod Kit	25.09
CTR-781-028	I-U-1	3" Rod Kit	27.26
CTR-781-029	I-U-1	3 1/2" Rod Kit	30.62
CTR-781-030	I-U-1	4" Rod Kit	34.34
CTR-781-034	I-U-1	4" Rod Kit	36.68
CTR-781-035	I-U-1	3-1/2" Rod Kit	37.63

Kit Number	Code (Pg. xiv)	Rod X Bore Size	List Price
CTR-781-036	I-U-1	4" Rod Kit	\$ 38.68
CTR-781-038	I-U-1	5" Rod Kit	58.74
CTR-781-039	I-U-1	1-1/8" Rod Kit	9.39
CTR-781-042	I-U-1	2-3/4" Rod Kit	24.05
CTR-781-043	I-U-1	1" Rod Kit	9.23
CTR-781-044	I-U-1	1-1/8" Rod Kit	9.69
CTR-781-049	I-U-1	2" Rod Kit	18.34
CTR-781-100	N-N-10	2" Piston Kit	6.68
CTR-781-101	N-N-10	2-1/2" Piston Kit	7.08
CTR-781-102	N-N-10	3" Piston Kit	10.84
CTR-781-103	N-N-10	3-1/2" Piston Kit	11.77
CTR-781-104	N-N-10	4" Piston Kit	11.92
CTR-781-105	N-N-10	4-1/2" Piston Kit	14.84
CTR-781-107	N-N-10	5-1/2" Piston Kit	16.45
CTR-781-108	N-N-10	6" Piston Kit	21.71
CTR-781-201	N-N-10	7" Piston Kit	27.61
CTR-781-203	N-N-10	9" Piston Kit	65.82
CTR-781-204	N-N-10	10" Piston Kit	97.41
CTR-781-206	N-N-10	12" Piston Kit	161.17
CTR-781-303	I-U-1	4" Rod Kit	28.12
CTR-781-305	I-U-1	2-1/4" Rod Kit	15.69
CTR-781-310	I-U-1	1-1/4" Rod Kit	9.61
CTR-781-312	I-U-1	1-3/4" Rod Kit	12.46
CTR-781-313	I-U-1	2" Rod Kit	14.14

CHIEF



CLARK LIFT TRUCKS

NOTE: A Clark deck number can positively identify the kit needed for lift cylinders. Looking at the upright (lift mechanism) from the driver's seat, the deck number is stamped on the right outer channel.

SAMPLE: MO141, HO351, FO168, etc.

ALSO NOTE: Kits with an "E" suffix contain original equipment u-seals. Kits without "E" suffix contain Hercules® Sealing Products designed seals.

Kit Number	Code (Pg. xiv)	Rod X Bore Size	List Price	Kit Number	Code (Pg. xiv)	Rod X Bore Size	List Price
CLK-1795529	I-U-5	1-1/2 X 4	\$ 52.63	CLK-1811164		1-3/4, 2-5/8, 3-3/8, 4-5/8 UID'S	\$ 86.42
CLK-1810820	O-RINGS		9.20	CLK-1811164-E		1-3/4, 2-5/8, 3-3/8, 4-5/8 UID'S	169.01
CLK-1811046	I-U-10	1-1/4 X 3	21.06	CLK-1811179	I-V-5	1-1/2 X 4	71.34
CLK-1811107	I-N-4	2 X 2-1/4	22.84	CLK-1811180	I-V-5	1-1/4 X 4	65.40
CLK-1811108	I-N-4	2-1/4 X 2-1/2	17.66	CLK-1811184	I-V-5	1-1/4 X 3	54.58
CLK-1811120		1-3/4, 3-1/8 VID, 3-7/8, 5-1/4 UID	127.85	CLK-1811200	I-V-4	2 X 6	129.08
CLK-1811120-E		1-3/4, 3-1/8 VID, 3-7/8, 5-1/4 UID	207.47	CLK-1811200-E	I-V-4	2 X 6	242.21
CLK-1811122		2-1/8 VID, 3-7/8, 4-3/4, 6-1/2 UID	171.64	CLK-1811204	I-V-1	1-1/4 ROD	70.77
CLK-1811122-E		2-1/8 VID, 3-7/8, 4-3/4, 6-1/2 UID	238.93	CLK-1811206	I-V-5	3/4 X 1-5/8	32.60
CLK-1811123		3-1/4, 4-1/4 VID'S, 6-1/2 UID'S	190.38	CLK-1811207	I-V-5	1 X 2	47.29
CLK-1811123-E		3-1/4, 4-1/4 VID'S, 6-1/2 UID'S	251.91	CLK-1811209	I-V-5	1 X 2-1/4	53.32
CLK-1811124		2-1/8, 3-1/8 VID'S	74.25	CLK-1811210	I-V-5	1-1/4 X 2-3/4	66.05
CLK-1811125		2-1/8, 3-1/8, 4-1/2 VID'S	135.94	CLK-1811212	I-V-5	1-1/4 X 3-1/4	68.77
CLK-1811126		2-3/4, 3-3/4, 5-3/4 VID'S	178.95	CLK-1811217	I-V-5	1-3/4 X 4-1/2	52.23
CLK-1811127		2-3/4, 3-3/4, 5-3/4 VID'S	183.08	CLK-1811218	I-V-5	2 X 6	274.86
CLK-1811129	I-N-4	2-1/2 X 4	37.05	CLK-1811231	N-N-5	2.26" Piston Kit	35.49
CLK-1811130		1-3/4, 2-5/8, 3-3/4 VID'S	106.90	CLK-1811244	I-U-10	1-1/8 X 2-1/4	16.19
CLK-1811131		1-3/4, 3-1/8 VID, 3-7/8, 5-1/4 UID	136.97	CLK-1811275	I-V-5	1-1/2 X 4	53.96
CLK-1811131-E		1-3/4, 3-1/8 VID, 3-7/8, 5-1/4 UID	186.91	CLK-1811309	I-U-10	1 X 3	12.09
CLK-1811132		1-3/4, 2-5/8 VID, 3-3/8, 4-1/2 UID	97.45	CLK-1811314		1-3/4 VID, 3-1/8, 3-7/8, 5-1/4 UID	113.34
CLK-1811132-E		1-3/4, 2-5/8 VID, 3-3/8, 4-1/2 UID	152.07	CLK-1811314-E		1-3/4 VID, 3-1/8, 3-7/8, 5-1/4 UID	162.02
CLK-1811133		1-3/4, 2-5/8 VID'S	50.67	CLK-1811315		1-3/4 VID, 3-1/8, 3-7/8, 5-1/4 UID	129.14
CLK-1811138		2-1/4, 3-1/4 VID'S	90.21	CLK-1811315-E		1-3/4 VID, 3-1/8, 3-7/8, 5-1/4 UID	164.39
CLK-1811142		1-3/4, 2-5/8, 3-3/4 VID'S	174.41	CLK-1811327		2-1/8 VID, 3-7/8, 4-3/4, 6-1/2 UID	151.42
CLK-1811148		2-1/8 VID, 3-7/8, 4-3/4, 6-1/2 UID	180.03	CLK-1811327-E		2-1/8 VID, 3-7/8, 4-3/4, 6-1/2 UID	238.66
CLK-1811148-E		2-1/8 VID, 3-7/8, 4-3/4, 6-1/2 UID	239.74	CLK-1811369	P-U-4	60 mm X 73 mm	57.02
CLK-1811149	I-U-4	3-1/2 X 4-3/4	82.57	CLK-1811376	I-U-10	40 mm X 4"	42.71
CLK-1811154	I-U-1	2-1/2 X 3-1/4	23.92	CLK-1811392	P-U-10	1-3/4 X 3	55.56
CLK-1811155	I-N-4	2-1/2 X 3	22.58	CLK-1811393	I-U-10	40 mm X 4"	47.24
CLK-1811157	I-U-5	5 X 7	152.32	CLK-1811415	P-U-4	60 X 78 mm	59.15
CLK-1811158	I-U-5	4-1/2 X 6	115.49	CLK-1811537	P-U-1	60 mm	59.44
CLK-1811158-E	I-U-5	4-1/2 X 6	142.71	CLK-1811538	I-U-4	40 X 56 mm	50.46
CLK-1811159		1-3/4, 3-1/8 VID, 3-7/8, 5-1/4 UID	129.31	CLK-1811542	I-U-10	1-3/8 X 3	27.62
CLK-1811159-E		1-3/4, 3-1/8 VID, 3-7/8, 5-1/4 UID	187.66	CLK-1811544	I-U-10	1 X 2	42.63
CLK-1811160		1-3/4, 2-5/8 VID, 3-3/8, 4-1/2 UID	96.75	CLK-1811569	P-U-10	2 X 3-3/8	41.89
CLK-1811160-E		1-3/4, 2-5/8 VID, 3-3/8, 4-1/2 UID	152.07	CLK-1811582	I-U-10	1-1/4 X 3-1/2	25.49
CLK-1811161		1-3/4, 3-1/8 VID, 3-7/8, 5-1/4 UID	130.30	CLK-1811691	P-U-1	2 X 2.450	26.31
CLK-1811161-E		1-3/4, 3-1/8 VID, 3-7/8, 5-1/4 UID	181.65	CLK-1811697	I-U-10	1-1/4 X 3-1/2	25.60
CLK-1811162		2-1/8, 3-1/8, 4-1/2 UID'S	138.61	CLK-1811719	I-U-10	40 mm X 3-1/2	30.46
CLK-1811163		2-1/8, 3-1/8, 4-1/2 VID'S	139.80	CLK-1811759	I-U-10	1-1/4 X 3	25.89

NORTH AMERICA
PHONE 1-800-777-5617
FAX 1-800-759-6391

SALES OFFICE HOURS
8 A.M. TO 8 P.M. EASTERN TIME
www.HerculesUS.com

WORLDWIDE
PHONE 1-727-796-1300
FAX 1-727-797-8849

CLARK LIFT TRUCKS

Kit Number	Code (Pg. xiv)	Rod X Bore Size	List Price
CLK-1811785	I-U-10	40 mm x 3-1/2	\$ 35.63
CLK-1811799	I-U-10	2 X 3-3/8	64.44
CLK-1811820	I-U-10	2 X 3	25.58
CLK-1811828	I-U-10	2 X 3	23.67
CLK-1811852	I-U-1	3 X 3-1/2	52.58
CLK-1811855	P-U-1	60 mm X 72 mm	36.02
CLK-1811972	I-U-10	1-1/4 X 3	33.50
CLK-1813014	P-U-1	2 X 2-1/2	30.74
CLK-1813015	I-U-1	2-5/8 Rod Kit	58.81
CLK-1813016	I-U-1	3 X 3-1/2	46.60
CLK-1813017	P-U-1	60mm X 72 mm	36.02
CLK-1813023	I-U-1	40 mm X 2-3/16"	35.26
CLK-1813024	I-U-1	40 mm Rod Kit	17.60
CLK-1813032	I-U-10	50 mm X 3-3/8"	56.27
CLK-1813055	I-U-10	50 mm X 3-1/8"	62.28
CLK-1813075	I-U-10	40 mm X 3-1/2"	34.85
CLK-1813076	I-U-10	40 mm X 4"	37.24
CLK-1813082	I-U-10	50 X 86 mm	51.51
CLK-1813084	I-U-1	50 mm Rod Kit	20.22
CLK-1813176	I-U-4	60 X 73 mm	63.32
CLK-1818816	P-U-10	3/4 X 1-3/4	22.58
CLK-1818864	P-U-10	3/4 X 2	16.76
CLK-1821328	I-U-10	7/8 X 2	11.77
CLK-1830350	I-N-4	2 X 2-1/4	24.69
CLK-1830352	I-N-4	3-1/4 X 4	33.19
CLK-1830358	I-N-4	2-1/2 X 3-1/4	40.61
CLK-1830360	I-N-4	2-1/2 X 3	25.14
CLK-1830361	I-N-4	2-1/4 X 2-1/2	27.65
CLK-1830649	I-U-10	3/4 X 2-3/4	27.36
CLK-1831042		1-1/4" Rod Kit	8.18

Kit Number	Code (Pg. xiv)	Rod X Bore Size	List Price
CLK-1831074	I-U-10	1-3/4 X 4-1/2	\$ 36.32
CLK-1831075	I-V-1	3-1/4 Rod Kit	36.23
CLK-1831076	I-U-10	1-1/8 X 2-1/2	22.84
CLK-2367420	I-U-1	2-1/4 X 3-1/4	87.07
CLK-3009626	P-U-10	25 mm X 50 mm	57.82
CLK-3986876	MOTOR KIT		21.62
CLK-841270	P-U-10	2 X 3-3/4	29.68
CLK-886547	P-TR-12	1 X 2	37.24
CLK-896505	MOTOR KIT		6.07
CLK-905074	MOTOR KIT		13.41
CLK-907984	VALVE KIT		15.18
CLK-908985	VALVE KIT		14.49
CLK-909619	VALVE KIT		54.80
CLK-912339	P-U-1	2-1/2 X 3	31.08
CLK-914698	I-U-4	1 X 2-1/2	23.02
CLK-914703	I-O-4	1-1/4 X 3	15.38
CLK-916351	MULTI STAGE	4, 4-3/4	464.80
CLK-917282	O-RING KIT		6.66
CLK-917713	N-N-10	2" Piston Kit	18.63
CLK-918886	I-U-10	2 X 3-3/8	31.99
CLK-921115A	VALVE KIT		8.82
CLK-990076	VALVE KIT		3.72
CLK-990208	SWIVEL KIT		5.93
CLK-990209	SWIVEL KIT		8.47
CLK-992511	O-RING KIT		6.09
CLK-994287	VALVE KIT		10.50
CLK-995815	SWIVEL KIT		8.88
CLK-999820	P-U-10	3/4 X 1-3/4	29.26

CLARK

**FOR CLARK-MICHIGAN CONSTRUCTION EQUIPMENT
SEE OUR LISTING OF KITS UNDER THE VOLVO SECTION IN THIS CATALOG.**

COMMERCIAL HYDRAULICS

- PACKING:** Vee packing with nylon top and bottom adaptors. 5/16" cross section.
- WIPERS:** .190 shoulder thickness on wipers.
- BEARINGS:** One above packing - may be either bronze or nylon.
- PISTON:** Welded to stage. Single action uses single nylon wear ring. Double action uses 3 cast iron piston rings and 2 nylon wear rings.
- STAGE O.D.'s:** 2.750; 3.750; 4.750; 5.750; 6.750; 7.905; 9.375
- SPECIAL INFO.:** Threaded internal stop ring. Uses wave spring under vee packing.
- IDENTIFICATION:** Cylinder number stamped on metal tag on cylinder body.
Ex: SD85MC-15-220 double acting
S85DC-40-190 single acting

COMMERCIAL

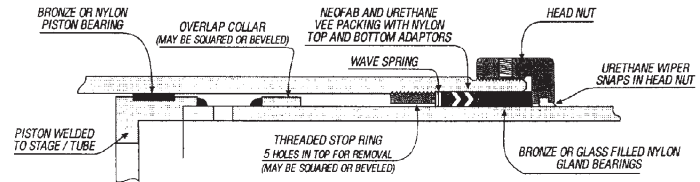

CYLINDER REBUILD KITS SINGLE ACTING DUMP BODY CYLINDERS		
Kit includes: Wiper Rings, Packing Assemblies, Bearing Rings, Piston Bearings, Wave Springs, Set Screws & Nylon Balls		
Part Number	Cyl. Model Number	List Price
CM-375-1804-017	S53	\$ 159.70
CM-375-1804-020	S62	146.08
CM-375-1804-018	S63	198.94
CM-375-1804-021	S64	240.04
CM-375-1804-019	S73	251.47
CM-375-1804-022	S74	328.26
CM-375-1804-023	S84	379.22
CM-375-1804-024	S85	448.99
CM-375-1804-025	S95	650.24
CYLINDER REPACK KITS SINGLE ACTING DUMP BODY CYLINDERS		
Kit includes: Wiper Rings, Packing Assemblies		
Part Number	Cyl. Model Number	List Price
CM-391-1804-020	S53	\$ 68.92
CM-375-1804-026	S62	64.60
CM-391-1804-109	S63	87.27
CM-391-1804-237	S64	105.02
CM-375-1804-002	S73	117.16
CM-375-1804-003	S74	139.85
CM-391-1804-054	S84	173.03
CM-391-1804-060	S85	195.72
CM-375-1804-004	S95	288.45
Part Number	Description	List Price
PACKING & WIPERS (INCLUDES SHIMS)		
CM-3VSW	2-3/4" Vee Set & Wiper	\$ 17.82
CM-4VSW	3-3/4" Vee Set & Wiper	23.07
CM-5VSW	4-3/4" Vee Set & Wiper	28.83
CM-6VSW	5-3/4" Vee Set & Wiper	36.74
CM-7VSW	6-3/4" Vee Set & Wiper	53.35
CM-8VSW	7.905" Vee Set & Wiper	56.75
CM-9.37VSW	9-3/8" Vee Set & Wiper	117.17

Part Number	Description	List Price
GLAND BEARINGS		
CM-275NB	2-3/4" Gland Bearing	\$ 15.63
CM-375NB	3-3/4" Gland Bearing	15.66
CM-475NB	4-3/4" Gland Bearing	24.02
CM-575NB	5-3/4" Gland Bearing	27.62
CM-675NB	6-3/4" Gland Bearing	29.00
CM-790NB	7.905" Gland Bearing	43.72
CM-937NB	9-3/8" Gland Bearing	95.00
GLAND BEARINGS KITS		
CM-NYB35	2-3/4" - 4-3/4" Gland Bearings	\$ 53.94
CM-NYB46	3-3/4" - 5-3/4" Gland Bearings	65.63
CM-NYB47	3-3/4" - 6-3/4" Gland Bearings	94.64
CM-NYB48	3-3/4" - 7.905" Gland Bearings	138.34
CM-NYB49	3-3/4" - 9-3/8" Gland Bearings	231.06
CM-NYB57	4-3/4" - 6-3/4" Gland Bearings	79.39
CM-NYB58	4-3/4" - 7.905" Gland Bearings	123.10
NYLON PISTON BEARINGS		
CM-U3023-32	2-3/4" Piston Bearing	\$ 3.94
CM-U3023-42	3-3/4" Piston Bearing	5.87
CM-U3023-52	4-3/4" Piston Bearing	5.93
CM-U3023-62	5-3/4" Piston Bearing	6.70
CM-U3023-72	6-3/4" Piston Bearing	7.68
CM-U3023-84	7.905" Piston Bearing	9.09
CM-U3023-98	9-3/8" Piston Bearing	18.43
CM-X29-1	Bleeder Valve	5.10
BRONZE PISTON BEARINGS		
CM-U3023-52B	4-3/4" Bronze Piston Bearings	\$ 64.82
CM-U3023-62B	5-3/4" Bronze Piston Bearings	76.78
CM-U3023-72B	6-3/4" Bronze Piston Bearings	74.02
CM-U3023-84B	7.905" Bronze Piston Bearings	99.04
CM-U3023-98B	9-3/8" Bronze Piston Bearings	190.20

COMMERCIAL HYDRAULICS

Part Number	Description	List Price
PISTON RINGS (Double Acting)		
CM-X78-4-25	3-3/4" Piston Ring	\$ 10.69
CM-X78-5-25	4-3/4" Piston Ring	14.06
CM-X78-6-25	5-3/4" Piston Ring	16.59
CM-X78-7-25	6-3/4" Piston Ring	24.57
CM-X78-8-437	7.905" Piston Ring	34.13
CM-X78-9-88	9-3/8" Piston Ring	71.97
KITS		
CM-35	2-3/4" - 4-3/4" Vee Sets & Wipers	\$ 68.93
CM-36	2-3/4" - 5-3/4" Vee Sets & Wipers	105.02
CM-38	2-3/4" - 7.905" Vee Sets & Wipers	213.54
CM-46	3-3/4" - 5-3/4" Vee Sets & Wipers	87.27
CM-47	3-3/4"-6-3/4" Vee Sets & Wipers	139.84
CM-48	3-3/4"-7.905" Vee Sets & Wipers	195.71
CM-49	3-3/4"-9-3/8" Vee Sets & Wipers	311.13
CM-56	4-3/4 - 5-3/4" Vee Sets & Wipers	64.60
CM-57	4-3/4"-6-3/4" Vee Sets & Wipers	117.16
CM-58	4-3/4"-7.905" Vee Sets & Wipers	173.03
CM-59	5"-9" Vee Sets & Wipers	282.78
CM-69	5-3/4"-9-3/8" Vee Sets & Wipers	220.83
CM-NPB35	2-3/4"-4-3/4" Piston Bearings	15.71
CM-NPB36	2-3/4"-5-3/4" Piston Bearings	44.50
CM-NPB46	3-3/4"-5-3/4" Piston Bearing	37.00
CM-NPB47	3-3/4"-6-3/4" Piston Bearings	26.19
CM-NPB48	3-3/4"-7.905" Piston Bearings	70.41
CM-NPB57	4-3/4"-6-3/4" Piston Bearings	20.31
CM-NPB58	4-3/4"-7.905" Piston Bearings	58.67
CM-NYB35	2-3/4"-4-3/4" Gland Bearings	53.94
CM-NYB36	2-3/4"-5-3/4" Gland Bearings	80.88
CM-NYB47	3-3/4"-6-3/4" Gland Bearings	94.64
CM-NYB48	3-3/4"-7.905" Gland Bearings	138.34
CM-NYB57	4-3/4"-6-3/4" Gland Bearings	79.39
CM-NYB58	4-3/4"-7.905" Gland Bearings	123.10
CM-NYB69	5-3/4"-9-3/8" Gland Bearings	147.09
CM-PR48	3-3/4"-7.905" Piston Rings	269.00
CM-PR58	4-3/4"-7.905" Piston Rings	235.26
THREADED STOPS		
CM-F3020	3-3/4" Threaded Stop Ring	\$ 93.54
CM-F4020	2-3/4" Threaded Stop Ring	95.96
CM-F5020	5-3/4" Threaded Stop Ring	105.27
CM-F6020	4-3/4" Threaded Stop Ring	110.81
CM-F7020	6-3/4" Threaded Stop Ring	121.95
CM-F9020	9-3/8" Threaded Stop Ring	294.08
CM-G8020	7.905" Threaded Stop Ring	137.07

Part Number	Description	List Price
HEAD NUTS (MEASURED AT WIPER I.D.)		
CM-MA3011-37	3-3/4" Bronze Internal Head Nut	\$ 125.99
CM-MA3011-47	4-3/4" Bronze Internal Head Nut	150.15
CM-MA3011-57	5-3/4" Bronze Internal Head Nut	193.94
CM-MA3011-67	6-3/4" Bronze Internal Head Nut	218.97
CM-MA3011-79	7.905" Bronze Internal Head Nut	286.53
CM-MA3011-93	9-3/8" Bronze Internal Head Nut	495.55
CM-YA3011-27	2-3/4" Steel External Head Nut	84.46
CM-YA3011-37	3-3/4" Steel External Head Nut	109.55
CM-YA3011-47	4-3/4" Steel External Head Nut	112.90
CM-YA3011-57	5-3/4" Steel External Head Nut	138.92
CM-YA3011-67	6-3/4" Steel External Head Nut	180.29
CM-YA3011-79	7.905" Steel External Head Nut	256.30
CM-YA3011-93	9-3/8" Steel External Head Nut	479.46
VALVE SERVICE KITS		
CM-391-1803-030	Valve Series A20 Service Kit	\$ 4.46
CM-391-1803-201	Valve Series A35 Service Kit	16.56
WAVE SPRINGS		
CM-P1327-27	2-3/4" Wave Spring	\$ 9.42
CM-P1327-37	3-3/4" Wave Spring	10.39
CM-P1327-47	4-3/4" Wave Spring	12.31
CM-P1327-57	5-3/4" Wave Spring	12.41
CM-P1327-67	6-3/4" Wave Spring	18.75
CM-P1327-79	7.905" Wave Spring	22.81
CM-P1327-93	9-3/8" Wave Spring	66.95

COMMERCIAL HYDRAULICS



CROSS

Kit Number	Code (Pg. xiv)	Rod X Bore Size	List Price
CR-1C 1480	P-U-5	1-1/16 X 2	\$ 25.61
CR-1C 4147	P-OB-3	1-1/8 X 3	11.56
CR-1C 4244	P-OB-3	1-1/16 X 2	14.55
CR-1C 4429	P-OB-3	1-1/4 X 3-1/2	13.09
CR-1C 4430	P-OB-3	1-1/4 X 4	13.70
CR-1C 4433	P-OB-3	1-1/16 X 2-1/2	15.16
CR-1C 4629	P-OB-3	1-1/4 X 3	9.95
CR-1C 4630	P-OB-3	1-1/2 X 3	10.17
CR-1C 4631	P-OB-3	1-1/2 X 3-1/2	13.43
CR-1C 4637	P-OB-3	1-1/2 X 4	19.25
CR-1C 4638	P-OB-3	2 X 4	13.53
CR-1C 4642	P-OB-3	3/4 X 1-1/2	17.02
CR-1C 4750	P-OB-3	1 X 2	10.17
CR-1C 4759	P-OB-3	1-1/4 X 2-1/2	10.47
CR-1C 4765	P-OB-3	1-1/4 X 3	10.56
CR-1C 4785	P-OB-3	1-1/2 X 4	14.39
CR-1C 4786-A	P-OB-3	2 X 4	12.39
CR-1C 4796	P-OB-3	2-1/2 X 5	19.25
CR-1C 9964	P-U-5	2 X 4	50.61
CR-2C 1955	P-U-5	1-1/2 X 4	50.36
CR-2C 2842	P-OB-3	1-1/4 X 3	15.04
CR-2C 5395	P-U-5	3-1/2 X 6	82.44
CR-3C 2597	P-U-5	1-1/2 X 3	31.91
CR-3C 7684	P-OB-3	1-3/4 X 4	21.23

CROWN LIFT TRUCKS

Kit Number	Code (Pg. xiv)	Rod X Bore Size	List Price
CRN-089178	I-U-13	1-3/4 X 3-1/2	\$ 45.97
CRN-101296	I-U-1	2-1/2" Rod Kit	18.65
CRN-101301	I-U-1	2 ROD KIT	19.68
CRN-101302	I-U-1	1-7/8 X 2-1/2	60.96
CRN-101305	I-U-1	1-5/8 X Rod Kit	89.47
CRN-101309	I-U-1	1-7/8" ROD KIT	63.96
CRN-101310	I-U-1	2-1/2" ROD KIT	24.60
CRN-101313	I-U-1	1-3/8" Rod Kit	23.48
CRN-101314	I-U-1	2-1/8" ROD KIT	18.14
CRN-101316	I-U-1	2-3/8" ROD KIT	42.35
CRN-101323	I-V-1	1-7/8" Rod Kit	58.22
CRN-101326	I-U-1	2-3/8" Rod Kit	28.75
CRN-101329	I-U-1	1-7/8, 2-5/8 Stages	71.55

CROWN LIFT TRUCKS

Kit Number	Code (Pg. xiv)	Rod X Bore Size	List Price
CRN-101331	I-U-1	1-3/4, 2-3/8 Stages	\$ 57.38
CRN-101332	I-U-1	1-3/4 X 2-1/2	19.14
CRN-101334	I-U-1	1-7/8, 2-5/8 Rod kit	70.24
CRN-101335	I-U-N	1-5/8, 2-1/4 Stages	62.19
CRN-101336	I-U-1	1-5/8, 2-1/4 Stages	63.25
CRN-101339	I-U-1	2" Rod Kit	63.23
CRN-101340	I-U-1	1-7/8 ROD KIT	19.54
CRN-101341	I-U-5	1-1/4 X 2-3/8	47.79
CRN-101342	I-U-3	1-1/2 X 3	48.15
CRN-101343	1-U-5	3/4 X 2	55.73
CRN-101346	I-U-5	3/4 X 1-3/4	39.84
CRN-101347	I-U-5	3/4 X 2-1/8	54.91
CRN-101376	I-U-5	1-1/4 X 3	52.74
CRN-101377	I-U-5	1 x 1-3/4	41.06
CRN-102659		VALVE KIT	4.44
CRN-105476004		O-RING	6.66
CRN-105476-6		O-RING	2.22
CRN-107366	I-O-1	1/2" Valve Kit	16.19
CRN-111573	I-U-1	3" ROD KIT	32.16
CRN-111574	I-U-1	2" ROD KIT	20.63
CRN-111790-001		O-RING	2.22
CRN-111790-12		O-RING	2.22
CRN-111790-2		O-RING	4.44
CRN-111790-3		O-RING	2.79
CRN-111790-4		O-RING	2.79
CRN-111790-9		O-RING	2.64
CRN-112022	I-U-4	7/8 X 2	18.87
CRN-112704		8, 9/16" Spools Rod Kit	17.25
CRN-113744	I-U-13	2-1/2 X 3-1/4	51.67
CRN-113745	I-U-13	3/4 x 1-3/4	24.95
CRN-115604	I-U-4	7/8 X 2	31.80
CRN-116360	N-O-1	o-ring	4.92
CRN-116820	I-U-1	2" rod kit	13.87
CRN-42249	I-U-1	56 X 80 mm	34.68
CRN-43023-1		VALVE KIT	28.44
CRN-78685		VALVE KIT	13.23
CRN-79017		VALVE KIT	4.08
CRN-87317	N-O-1	o-ring	3.62
CRN-87484		O-RING	3.78
CRN-88719		O-RING	3.38
CRN-89704	I-U-13	1-3/4 x 2-3/4	44.84
CRN-90880	I-U-5	3/4 X 1-3/4	41.38
CRN-93217		O-RING	3.62
CRN-94580	I-O-1	5/8" Rod kit	4.83

CUSTOM HOISTS 700 SERIES

- PACKING:** Vee packing with nylon top and bottom adapters.
WIPERS: An improved dual-lip snap in wiper to minimize contamination entry.
Bearing: Top mineral filled nylon bearing.
Retainer Ring: Heavy duty for improved strength.
Plunger Stop: Beveled plunger stop for plunger center.
Piston Wear Ring: Wear ring with increased cross-section for added strength.
Stage O.D.: 3-3/16", 4-1/8", 5-1/16" & 6"
Identification: Part number and serial number stamped in body near base of cylinder. Ex. 63-702-120

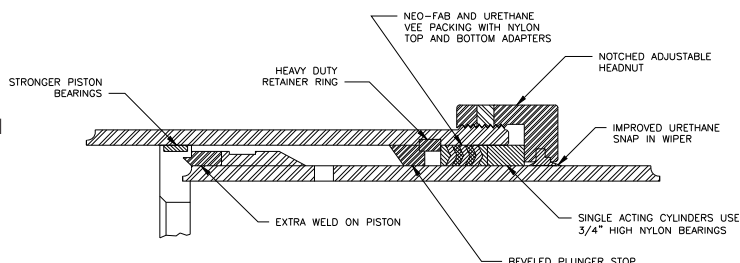

Part Number	Description	List Price
SEAL KITS		
CH-SK-53-700	3 - 5" Seal Kit	\$ 81.67
CH-SK-63-700	4 - 6" Seal Kit	93.46
CH-SK-64-700	3 - 6" Seal Kit	115.25
CH-SK-74-700	4 - 7" Seal Kit	168.63
MINOR PACKING KITS		
CH-MPK-53-700	3 - 5" Minor Packing Kit	\$ 143.28
CH-MPK-63-700	4 - 6" Minor Packing Kit	156.58
CH-MPK-64-700	3 - 6" Minor Packing Kit	197.35
CH-MPK-74-700	4 - 7" Minor Packing Kit	298.02
MAJOR PACKING KITS		
CH-MRK-53-700	3 - 5" Major Repair Kit	\$ 447.57
CH-MRK-63-700	4 - 6" Major Repair Kit	482.25
CH-MRK-64-700	3 - 6" Major Repair Kit	602.42
CH-MRK-74-700	4 - 7" Major Repair Kit	722.33
NYLON TOP BEARINGS		
CH-1BU11-3-3/16	3-3/16" Nylon Top Bearing	\$ 14.35
CH-1BU11-4-1/8	4-1/8" Nylon Top Bearing	14.81
CH-1BU11-5-1/16	5-1/16" Nylon Top Bearing	14.88
CH-1BU11-6	6" Nylon Top Bearing	11.75
CH-1BU11-7	7" Nylon Top Bearing	12.79
PACKINGS		
CH-700-3-3/16VS	3-3/16" Vee Set	\$ 16.33
CH-700-4-1/8VS	4-1/8" Vee Set	18.97
CH-700-5-1/16VS	5-1/16" Vee Set	23.54
CH-700-6VS	6" Vee Set	19.93
CH-PK-1-7	7" Vee Set	24.86

Part Number	Description	List Price
WIPERS		
CH-1WR1-3-3/16	3-3/16" Wiper	\$ 4.79
CH-1WR1-4-1/8	4-1/8" Wiper	6.23
CH-1WR1-5-1/16	5-1/16" Wiper	7.68
CH-1WR1-6	6" Wiper	6.45
CH-1WR1-7	7" Wiper	7.97
RETAINER RINGS		
CH-2RR58-368	3-11/16" Retainer Ring	\$ 45.06
CH-2RR58-462	4-5/8" Retainer Ring	45.06
CH-2RR58-550	5-1/2" Retainer Ring	47.30
CH-2RR58-650	6-1/2" Retainer Ring	44.83
CH-2RR58-750	7" Retainer Ring	54.72
PLUNGER STOP		
CH-2PS44-3-3/16	3-3/16" Plunger Stop	\$ 63.15
CH-2PS44-4-1/8	4-1/8" Plunger Stop	64.71
CH-2PS44-5-1/16	5-1/16" Plunger Stop	68.05
CH-2PS44-6	6" Plunger Stop	68.44
CH-2PS36-7	7" Plunger Stop	79.00
PISTON WEAR RINGS		
CH-2WG3-3-3/16	3-3/16" Piston Wear Ring	\$ 4.17
CH-2WG3-4-1/8	4-1/8" Piston Wear Ring	5.24
CH-2WG3-5-1/16	5-1/16" Piston Wear Ring	6.17
CH-2WG3-6	6" Piston Wear Ring	7.45
CH-2WG1-7	7" Piston Wear Ring	6.08
WAVE SPRING		
CH-1WA11-7	7" Wave Spring	\$ 32.32
BUSHING		
CH-1BU195-7	7" Bushing	\$ 16.27

CUSTOM HOISTS

CUSTOM HOISTS 400 SERIES

PACKING: Vee packing with nylon top and bottom adapters.
WIPERS: An improved dual-lip snap in wiper to minimize contamination entry.
WAVE SPRING: To apply a continuous force on the packing.
BEARINGS: Top and bottom mineral filled nylon bearing.
RETAINER RING: Heavy duty for improved strength.
PLUNGER STOP: Beveled plunger stop for plunger centering.
PISTON WEAR RING: Wear ring with increased cross-section for added strength.
STAGE O.D.'S: 3, 4, 5, 6, 7, 8, 8-1/4, 9-1/8, 9-3/4
IDENTIFICATION: Part number and serial number stamped in body near oil port near base of cylinder.
 Example: 85-402-250 single acting.

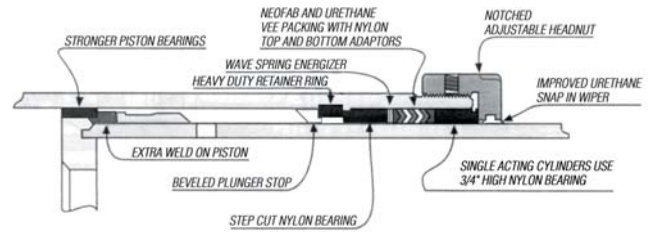

Part Number	Description	List Price
SEAL KITS		
CH-SK-53-400	3 - 5" Seal Kit	\$ 106.56
CH-SK-63-400	4 - 6" Seal Kit	128.24
CH-SK-64-400	3 - 6" Seal Kit	160.25
CH-SK-73-400	5 - 7" Seal Kit	168.15
CH-SK-74-400	4 - 7" Seal Kit	200.70
CH-SK-8-1/4 5-400	4 - 8-1/4" Seal Kit	347.60
CH-SK-84-400	5 - 8" Seal Kit	251.52
CH-SK-85-400	4 - 8" Seal Kit	284.39
CH-SK-95-400	5 - 9-1/8" Seal Kit	394.17
MINOR PACKING KITS		
CH-MPK-53-400	3 - 5" Minor Packing Kit	\$ 175.19
CH-MPK-63-400	4 - 6" Minor Packing Kit	200.84
CH-MPK-64-400	3 - 6" Minor Packing Kit	254.85
CH-MPK-73-400	5 - 7" Minor Packing Kit	247.10
CH-MPK-74-400	4 - 7" Minor Packing Kit	301.97
CH-MPK-8-1/4 5-400	4 - 8-1/4" Minor Packing Kit	537.98
CH-MPK-84-400	5 - 8" Minor Packing Kit	387.83
CH-MPK-85-400	4 - 8" Minor Packing Kit	417.88
CH-MPK-95-400	5 - 9" Minor Packing Kit	818.33
MAJOR REPAIR KITS		
CH-MRK-53-400	3 - 5" Major Repair Kit	\$ 525.13
CH-MRK-63-400	4 - 6" Major Repair Kit	551.00
CH-MRK-64-400	3 - 6" Major Repair Kit	721.23
CH-MRK-73-400	5 - 7" Major Repair Kit	593.96
CH-MRK-74-400	4 - 7" Major Repair Kit	768.72
CH-MRK-8-1/4 5-400	4 - 8" Major Repair Kit	1503.69
CH-MRK-84-400	5 - 8" Major Repair Kit	869.76
CH-MRK-85-400	4 - 8" Major Repair Kit	1044.89
CH-MRK-95-400	5 - 9" Major Repair Kit	1641.14
PACKING & WIPERS		
CH-400-3VSW	3" Vee Set & Wiper	\$ 13.94
CH-400-4VSW	4" Vee Set & Wiper	19.80
CH-400-5VSW	5" Vee Set & Wiper	23.85
CH-400-6VSW	6" Vee Set & Wiper	29.57
CH-400-7VSW	7" Vee Set & Wiper	35.29
CH-400-8.25VSW	8-1/4" Vee Set & Wiper	98.33
CH-400-8VSW	8" Vee Set & Wiper	43.04
CH-400-9.12VSW	9-1/8" Vee Set & Wiper	122.34
NYLON BOTTOM BEARINGS		
CH-1BU195-3	3" Nylon Bottom Bearing	\$ 11.93
CH-1BU195-4	4" Nylon Bottom Bearing	12.26
CH-1BU195-5	5" Nylon Bottom Bearing	13.34
CH-1BU195-6	6" Nylon Bottom Bearing	14.35
CH-1BU195-7	7" Nylon Bottom Bearing	16.27
CH-1BU195-8	8" Nylon Bottom Bearing	19.07
CH-1BU195-825	8-1/4" Nylon Bottom Bearing	44.55
CH-1BU195-91	9-1/8" Nylon Bottom Bearing	29.07
NYLON TOP BEARINGS		
CH-1BU11-3	3" Nylon Top Bearing	\$ 9.43
CH-1BU11-4	4" Nylon Top Bearing	9.43

Part Number	Description	List Price
NYLON TOP BEARINGS		
CH-1BU11-5	5" Nylon Top Bearing	\$ 9.93
CH-1BU11-6	6" Nylon Top Bearing	11.75
CH-1BU11-7	7" Nylon Top Bearing	12.79
CH-1BU11-8	8" Nylon Top Bearing	15.49
CH-1BU11-82	8-1/4" Nylon Top Bearing	29.34
CH-1BU11-91	9-1/8" Nylon Top Bearing	35.22
RETAINER RINGS		
CH-2RR58-350	3-1/2" Retainer Ring	\$ 50.98
CH-2RR58-450	4-1/2" Retainer Ring	49.82
CH-2RR58-550	5-1/2" Retainer Ring	47.30
CH-2RR58-650	6-1/2" Retainer Ring	44.83
CH-2RR58-750	7-1/2" Retainer Ring	54.72
CH-2RR58-850	8-1/2" Retainer Ring	70.96
CH-2RR58-9	9" Retainer Ring	209.22
CH-2RR58-975	9-3/4" Retainer Ring	150.54
WAVE SPRINGS		
CH-1WA11-3	3" Wave Spring	\$ 14.03
CH-1WA11-4	4" Wave Spring	15.20
CH-1WA11-5	5" Wave Spring	16.88
CH-1WA11-6	6" Wave Spring	19.92
CH-1WA11-7	7" Wave Spring	32.32
CH-1WA11-8	8" Wave Spring	34.72
CH-1WA11-825	8-1/4" Wave Spring	36.66
CH-1WA11-91	9-1/8" Wave Spring	39.21
PLUNGER STOPS		
CH-2PS36-3	3" Plunger Stop	\$ 73.39
CH-2PS36-4	4" Plunger Stop	74.79
CH-2PS36-5	5" Plunger Stop	75.01
CH-2PS36-6	6" Plunger Stop	77.59
CH-2PS36-7	7" Plunger Stop	79.00
CH-2PS36-8	8" Plunger Stop	98.43
CH-2PS36-825	8-1/4" Plunger Stop	116.72
CH-2PS36-91	9-1/8" Plunger Stop	193.67
PISTON WEAR RINGS		
CH-2WG1-3	3" Piston Wear Ring	\$ 4.12
CH-2WG1-4	4" Piston Wear Ring	4.43
CH-2WG1-5	5" Piston Wear Ring	4.50
CH-2WG1-8	8" Piston Wear Ring	10.99
CH-2WG1-6	6" Piston Wear Ring	5.09
CH-2WG1-7	7" Piston Wear Ring	6.08
CH-2WG1-91	9-1/8" Piston Wear Ring	17.93
WIPERS		
CH-1WR1-3	3" WIPER	\$ 3.80
CH-1WR1-4	4" WIPER	4.55
CH-1WR1-5	5" WIPER	5.47
CH-1WR1-6	6" WIPER	6.45
CH-1WR1-7	7" WIPER	7.97
CH-1WR1-8	8" WIPER	9.42
CH-1WR1-825	8-1/4" WIPER	13.38
CH-1WR1-91	9.12" WIPER	19.37

CUSTOM HOISTS TELESCOPICS

- PACKING:** Vee packing with nylon top and bottom adaptors.
4" thru 8" all 1/4" c.s.
- WIPERS:** Snap in.
- BEARINGS:** One bronze or mineral filled nylon bearing above the packing.
- PISTON:** Steel pistons welded to stage. Replaceable "T" shaped nylon wear rings. Double action use 2 cast iron piston rings in separate grooves.
- STAGE O.D.'s:** 3, 4, 5, 6, 7, 8, 8-1/4, 9-1/8, 9-3/4
- SPECIAL INFO.:** Uses 2 spiral retainer rings with metal spacer in between.
- IDENTIFICATION:** Part number and serial number stamped in body near oil port near base of cylinder.
Example: 85-2-220 single acting;
DAT73-4-128 double acting

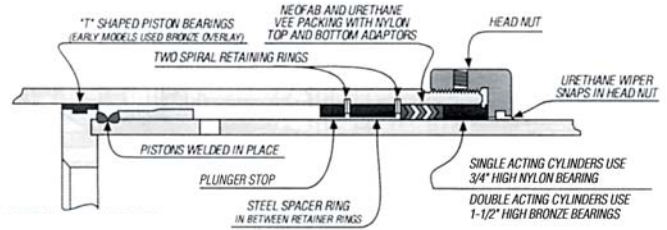

Part Number	Description	List Price
PACKING & WIPERS		
CH-3VSW	3" Vee Set & Wiper	\$ 13.48
CH-4VSW	4" Vee Set & Wiper	14.98
CH-5.87VSW	5-7/8" Vee Set & Wiper	26.10
CH-5VSW	5" Vee Set & Wiper	20.70
CH-6VSW	6" Vee Set & Wiper	25.23
CH-7VSW	7" Vee Set & Wiper	29.47
CH-8.25VSW	8-1/4" Vee Set & Wiper	75.88
CH-8VSW	8" Vee Set & Wiper	33.19
CH-9.12VSW	9-1/8" Vee Set & Wiper	109.63
CH-9.75VSW	9-3/4" Vee Set & Wiper	164.03
NYLON TOP BEARINGS		
CH-1BU11-3	3" Nylon Top Bearing	\$ 9.43
CH-1BU11-4	4" Nylon Top Bearing	9.43
CH-1BU11-5	5" Nylon Top Bearing	9.93
CH-1BU11-6	6" Nylon Top Bearing	11.75
CH-1BU11-7	7" Nylon Top Bearing	12.79
CH-1BU11-8	8" Nylon Top Bearing	15.49
CH-1BU11-82	8-1/4" Nylon Top Bearing	29.34
CH-1BU11-91	9-1/8" Nylon Top Bearing	35.22
CH-1BU1291/8	9-1/8" Nylon Top Bearing 1-1/2" Tall	66.59
BRONZE TOP BEARINGS		
CH-1BU3-3	3" X 3-1/2" X 1-1/2" Bronze Top Bearing	\$ 68.14
CH-1BU3-4	4" X 4-1/2" X 1-1/2" Bronze Top Bearing	94.44
CH-1BU3-5	5" X 5-1/2" X 1-1/2" Bronze Top Bearing	100.60
CH-1BU3-587	5-7/8" X 6-3/8" X 1-1/2" Bronze Top Bearing	97.38
CH-1BU3-6	6" X 6-1/2" X 1-1/2" Bronze Top Bearing	111.48
CH-1BU3-7	7" X 7-1/2" X 1-1/2" Bronze Top Bearing	128.16
CH-1BU3-8	8" X 8-1/2" X 1-1/2" Bronze Top Bearing	146.68
CH-1BU3-825	8-1/4" X 9" X 1-1/2" Bronze Top Bearing	146.21
CH-1BU3-975	9-3/4" X 10-1/2" X 1-1/2" Top Bearing	178.15
SPIRAL RETAINER RINGS		
CH-1RR1-35	3-1/2" Bore Spiral Retainer Ring	\$ 3.87
CH-1RR1-45	4-1/2" Bore Spiral Retainer Ring	9.21
CH-1RR1-55	5-1/2" Bore Spiral Retainer Ring	9.43
CH-1RR1-637	6-3/8" Bore Spiral Retainer Ring	69.83
CH-1RR1-65	6-1/2" Bore Spiral Retainer Ring	7.30
CH-1RR1-75	7-1/2" Bore Spiral Retainer Ring	9.67
CH-1RR1-85	8-1/2" Bore Spiral Retainer Ring	11.98
CH-1RR1-9	9" Bore Spiral Retainer Ring	68.19
CH-1RR1-97	9-3/4" Bore Spiral Retainer Ring	77.65
CH-1RR1-105	10-1/2" Bore Spiral Retainer Ring	100.82

Part Number	Description	List Price
SPACER RINGS		
CH-2SP1-3	3" Spacer	\$ 26.22
CH-2SP1-4	4" Spacer	47.70
CH-2SP1-5	5" Spacer	45.67
CH-2SP1-5-7/8	5-7/8" Spacer	92.14
CH-2SP1-6	6" Spacer	51.26
CH-2SP1-7	7" Spacer	63.79
CH-2SP1-8	8" Spacer	79.44
CH-2SP1-8.25	8-1/4" Spacer	355.80
CH-2SP1-9.12	9-1/8" Spacer	130.57
T-SHAPED PISTON WEAR RINGS		
CH-2GR6-3	3" Piston Wear Ring	\$ 6.58
CH-2GR6-4	4" Piston Wear Ring	7.09
CH-2GR6-5	5" Piston Wear Ring	9.06
CH-2GR6-587	5-7/8" Piston Wear Ring	11.23
CH-2GR6-6	6" Piston Wear Ring	11.23
CH-2GR6-7	7" Piston Wear Ring	12.22
CH-2GR6-8	8" Piston Wear Ring	20.15
CH-2GR6-825	8-1/4" Piston Wear Ring	28.79
CH-2GR6-91	9-1/8" Piston Wear Ring	28.79
CH-2GR6-975	9-3/4" Piston Wear Ring	30.23
PISTON WEAR RINGS		
CH-2WG1-3	3" Piston Wear Ring	\$ 4.12
CH-2WG1-4	4" Piston Wear Ring	4.43
CH-2WG1-5	5" Piston Wear Ring	4.50
CH-2WG1-8	8" Piston Wear Ring	10.99
CH-2WG1-6	6" Piston Wear Ring	5.09
CH-2WG1-7	7" Piston Wear Ring	6.08
CH-2WG1-91	9-1/8" Piston Wear Ring	17.93
PISTON RINGS (DOUBLE ACTING)		
CH-2PR3-35	3-1/2" Piston Ring	\$ 9.73
CH-2PR3-45	4-1/2" Piston Ring	13.18
CH-2PR3-55	5-1/2" Piston Ring	16.92
CH-2PR3-637	6-3/8" Piston Ring	80.53
CH-2PR3-65	6-1/2" Piston Ring	27.41
CH-2PR3-75	7-1/2" Piston Ring	25.73
CH-2PR3-85	8-1/2" Piston Ring	34.67
CH-2PR3-97	9-3/4" Piston Ring	71.35
CH-2PR3-105	10-1/2" Piston Ring	111.19

CUSTOM HOISTS



CUSTOM HOISTS TELESCOPICS

CUSTOM HOISTS

Part Number	Description	List Price
KITS		
CH-35	3" - 5" Vee Set & Wiper	\$ 49.70
CH-46	4" - 6" Vee Set & Wiper	62.00
CH-47	4" - 7" Vee Set & Wiper	92.20
CH-48	4" - 8" Vee Set & Wiper	126.19
CH-48-1/4	4" - 8 - 1/4" Vee Set & Wiper	169.92
CH-49	4" - 9 - 1/8" Vee Set & Wiper	238.49
CH-57	Custom #73-81-114, 129, 149	77.18
CH-57	5" - 7" Vee Set & Wiper	77.18
CH-58	5" - 8" Vee Set & Wiper	111.20
CH-59	5" - 9-1/8" Vee Set & Wiper	223.49
CH-NPB35	3" - 5" Nylon Piston Wear Ring Kit	22.74
CH-NPB36	3" - 6" Nylon Piston Wear Ring Kit	33.98
CH-NPB46	4" - 6" Nylon Piston Wear Ring Kit	27.39
CH-NPB47	4" - 7" Nylon Piston Wear Ring Kit	39.61
CH-NPB48	4" - 8" Nylon Piston Wear Ring Kit	59.76
CH-NPB48-1/4	4" - 8-1/4" Nylon Piston Wear Ring Kit	68.40
CH-NPB49	4" - 9-1/8" Nylon Piston Wear Ring	88.55
CH-NPB57	5" - 7" Piston Wear Ring Kit	32.51
CH-NPB58	5" - 8" Piston Wear Ring Kit	52.63
CH-NPB59	5" - 9-1/8" Piston Wear Ring Kit	81.44
CH-NYB35-DA	2 ea. 3" - 5" Nylon Top Bearings	56.28
CH-NYB35-SA	1 ea. 3" - 5" Nylon Top Bearings	28.14
CH-NYB36-DA	2 ea. 3" - 6" Nylon Top Bearings	79.26
CH-NYB36-SA	1 ea. 3" - 6" Nylon Top Bearings	39.63
CH-NYB46-DA	2 ea. 4" - 6" Nylon Top Bearings	60.78
CH-NYB46-SA	1 ea. 4" - 6" Nylon Top Bearings	30.39
CH-NYB47-DA	2 ea. 4" - 7" Nylon Top Bearings	85.75
CH-NYB47-SA	1 ea. 4" - 7" Nylon Top Bearings	42.87
CH-NYB48-1/4	1 ea. 4" - 8-1/4" Nylon Top Bearings	71.51
CH-NYB48-DA	2 ea. 4" - 8" Nylon Top Bearings	115.97
CH-NYB48-SA	1 ea. 4" - 8" Nylon Top Bearings	57.97
CH-NYB49-DA	2 ea. 4" - 8" Nylon Top Bearing & 1 ea. 9-1/8" Nylon Top Bearings	203.24
CH-NYB57-DA	2 ea. 5" - 7" Nylon Top Bearings	67.30
CH-NYB57-SA	1 ea. 5" - 7" Nylon Top Bearings	33.64
CH-NYB58-DA	2 ea. 5" - 8" Nylon Top Bearings	97.51
CH-NYB58-SA	1 ea. 5" - 8" Nylon Top Bearings	48.75
CH-NYB59-DA	2 ea. 5" - 9-1/8" Nylon Top Bearings	192.15
CH-NYB59-SA	1 ea. 5" - 9" Nylon Top Bearings	96.84
CH-PR35	2 ea. 3-1/2" - 5-1/2" Piston Rings	82.51
CH-PR36	2 ea. 3-1/2" - 6-1/2" Piston Rings	137.36
CH-PR46	2 ea. 4-1/2" - 6-1/2" Piston Rings	115.07
CH-PR47	2 ea. 4-1/2" - 7-1/2" Piston Rings	166.51
CH-PR48	2 ea. 4-1/2" - 8-1/2" Piston Rings	235.82
CH-PR49	2 ea. 4-1/2" - 9-3/4" Piston Rings	378.54
CH-PR57	2 ea. 5-1/2" - 7-1/2" Piston Rings	140.15
CH-PR58	2 ea. 5-1/2" - 8-1/2" Piston Rings	209.46

Part Number	Description	List Price
KITS		
CH-PR59	2 ea. 5-1/2" - 9-3/4" Piston Rings	\$ 352.17
CH-PS1-3	3" Plunger Stop	33.83
CH-PS1-4	4" Plunger Stop	75.86
CH-PS1-5	5" Plunger Stop	81.03
CH-PS1-587	5-7/8" Plunger Stop	96.42
CH-PS1-6	6" Plunger Stop	77.31
CH-PS1-7	7" Plunger Stop	57.29
CH-PS1-8	8" Plunger Stop	50.30
CH-PS1-82	8-1/4" Plunger Stop	88.28
CH-PS1-91	9-1/8" Plunger Stop	96.62
CH-PS1-975	9-3/4" Plunger Stop	99.24
CH-SR35	2 ea. 3-1/2" - 5-1/2" Spiral Retainer	44.13
CH-SR36	2 ea. 3-1/2" - 6-1/2" Spiral Retainer	58.69
CH-SR46	2 ea. 4-1/2" - 6-1/2" Spiral Retainer	53.28
CH-SR47	2 ea. 4-1/2" - 7-1/2" Spiral Retainer	73.11
CH-SR48	2 ea. 4-1/2" - 8-1/2" Spiral Retainer	97.74
CH-SR48-1/4	2 ea. 4-1/2" - 9" Spiral Retainer	281.24
CH-SR49	2 ea. 4-1/2" - 9-3/4" Spiral Retainer	253.06
CH-SR57	2 ea. 5-1/2" - 7-1/2" Spiral Retainer	54.20
CH-SR58	2 ea. 5-1/2" - 8-1/2" Spiral Retainer	78.83
CH-SR59	2 ea. 5-1/2" - 9-3/4" Spiral Retainer	234.15
HEAD NUTS (Measured at thread - have 12th/in)		
CH-2HN-4	4" Head Nut	\$ 73.33
CH-2HN-5	5" Head Nut	75.42
CH-2HN-6	6" Head Nut	99.78
CH-2HN-7	7" Head Nut	104.03
CH-2HN-8	8" Head Nut	125.17
CH-2HN-82	8-1/4" Head Nut	262.07
CH-2HN-9	9" Head Nut	171.66
CH-3HN1-11.25	11-1/4" Head Nut (over 9-3/4" Stage)	479.25
CH-3HN1-9.75	9-3/4" Head Nut (over 8-1/4" Stage)	356.21
CH-3HN1-11.25	11-1/4" Head Nut (over 9-3/4" Stage)	479.25
CH-3HN1-9.75	9-3/4" Head Nut (over 8-1/4" Stage)	356.21
MISCELLANEOUS PARTS		
CH-ABVA-1	Automatic Bleeder	\$ 45.97
CH-MBVA-1	Manual Bleeder valve	5.10
CH-MBVA-3	OEM Style Manual Bleeder Valve	28.86
CH-SL-2-1	Nylon Slug	0.58
CH-SS-3-1	Set Screw	1.16
MAJOR REPAIR KITS (SINGLE ACTING)		
Kits include: Packing, wipers, nylon bushings, snap rings, piston bearing, set screws and nylon slugs.		
CH-MRK-63	4" - 6"	\$175.74
CH-MRK-74	4" - 7"	224.98
CH-MRK-84	5" - 8"	284.64
CH-MRK-85	4" - 8"	343.12
CH-MRK-95	5" - 9-1/8"	654.07

CUSTOM HOISTS PISTON-ROD CYLINDERS

Kit Number	Cylinder Number	Code (Pg. xiv)	RodXBore Size	List Price
CH-SK-4-1/2-15	DA4-1/2-44-21	I-V-5	3 X 4-1/2	\$ 45.35
CH-SK-4-1/2-6	DA4-1/2-21	I-U-11	2 X 4-1/2	56.24
CH-SK-4-1/2-8	DA4-1/2-41-48-5/8	P-U-12	2 X 4-1/2	87.25
CH-SK-4-13	DA4-126-28	I-U-5	2-3/4 X 4	38.90
CH-SK-4-19	SA4-11-25	I-V-1	4" Rod Kit	25.30
CH-SK-4-21	DA4-142-21-1/2	I-V-10	2-1/2 X 4	32.91
CH-SK-4-23	DA4-171-27-3/4	I-V-10,12	2-3/4 X 4	36.96
CH-SK-4-4	DA4-77-14	I-V-5	1-3/4 X 4	33.08
CH-SK-4-5	DA4-107-24	I-U-5	2-1/2 X 4	39.10
CH-SK-4-6	DA4-104-48	I-U-5	2 X 4	40.12
CH-SK-5-1	DA5-67-14	I-U-5	2 X 5	38.66
CH-SK-5-12	DA5-144-36	I-V-11,12	2-1/2 X 5	85.32
CH-SK-5-13	DA5-47-27	I-V-5	3 X 5	67.82
CH-SK-5-21	DA5-130-16	I-V-5	2-1/2 X 5	63.03
CH-SK-5-28	DA5-41-19,20,23	I-V-5	3 X 5	64.07
CH-SK-5-35	DA5-4-26	I-V-9	2-1/2 X 5	53.72
CH-SK-6-1	DA6-60, DA6-90,	I-V-1	4-1/2 X 6	30.47
CH-SK-6-11	DA6-39-78	I-V-5	4-1/2 X 6	117.66
CH-SK-6-15		I-V-5	3-1/2 X 6	100.73
CH-SK-6-2	DA6-39-78,	I-U-12	4-1/2 X 6	85.52
CH-SK-6-22	DA6-140	I-V-5	4 x 6	58.78
CH-SK-6-23	DA6-92-46,62,68	I-V-12	4-1/2 X 6	89.01
CH-SK-6-26	DA6-73-34	I-V-5	2-1/2 X 6	53.20
CH-SK-6-29	DA6-158-42	I-U-5	2-3/4 X 6	71.40
CH-SK-6-30	DA6-49-78	I-U-12	4 X 6	81.26

Kit Number	Cylinder Number	Code (Pg. xiv)	RodXBore Size	List Price
CH-SK-6-31	DA6-40-108	I-U-12	4-1/2 X 6	\$ 102.98
CH-SK-6-33		I-U-1	4" Rod Kit	19.29
CH-SK-6-34	DA6-100-63	I-V-10	4 X 6	75.68
CH-SK-6-42	DA6-188-60,	I-V-5	4 X 6	57.37
CH-SK-6-44	DA6-203-42	I-V-5	2-3/4 X 6	72.85
CH-SK-6-54	DA6-9-70-1/2,	I-V-10	4 X 6	89.78
CH-SK-6-6	DA6-47-47	P-V-5	4 X 6	59.83
CH-SK-6-8	DA6-68-79	I-U-5	4 X 6	58.88
CH-SK-7-1	DA7-5	I-U-12	5-1/2 X 7	148.03
CH-SK-7-16	DA7-4-23	I-V-5	3 X 7	67.36
CH-SK-7-17	DA7-78-79	I-V-5	4 X 7	70.34
CH-SK-7-18	DA-7-29	I-U-10	5-1/2 X 7	109.85
CH-SK-7-20	DA7-36-78,	I-U-12	4-1/2 X 7	102.05
CH-SK-7-34		I-V-4, 12	2-1/2 X 7	100.35
CH-SK-7-35	DA7-121,78,83 or 55	I-U-10	4-1/2 X 7	94.84
CH-SK-7-43		I-U-4	2 X 7	43.23
CH-SK-7-5	DA7-36-115	I-U-12	4-1/2 X 7	106.26
CH-SK-7-9	DA7-63	I-U-10	4-1/2 X 7	111.30
CH-SK-8-1		I-V-4	3 X 8	83.61
CH-SK-8-21	DA8-16-25	I-V-12	2-1/2 X 8	93.92
CH-SK-8-3		I-U-5	3 X 8	91.47
CH-SK-9-2	DA9-19-19	I-V-5	3-1/2 X 9	171.09
CH-SK-42-60	42-60-43 or CH-475 3"-4" Vee Set & Wiper Telescopic			30.15

CUSTOM HOISTS



DEMPSTER REFUSE TRUCKS

Kit Number	Cylinder Number	Code (Pg. xiv)	RodXBore Size	List Price
DD-350U	BB7053	P-U-5	2 X 3-1/2	\$ 40.80
DD-400V	CB3267, CB3574,	I-V-9	2 X 4	111.25
DD-401U	BB6579, 6581,	P-U-5	2 X 4	39.12
DD-500V	CB3248	I-V-9	2-1/2 X 5	136.97
DD-501U	BB6451	P-U-5	2-1/2 X 5	46.20
DD-520U	BB8000	P-U-5	2 X 5	46.79
DD-5470K	CB5470	I-V-1	3 X 3-1/2	21.57
DD-5937K	BB5937	I-V-9	2 X 5	110.68
DD-5938K	BB5938	I-V-9	3 X 5	122.30
DD-6888K	BB6888, BB8281	P-N-1	2-1/2 X 3-1/2	27.39
DD-6996K	BB6996, BB8010	P-U-5	3 X 5	52.84
DD-6997K	BB6997	P-U-5	2 X 5	47.84
DD-8112K	BB8112	P-U-5	2-1/2 X 6	75.22
DD-8133K	BB8133	P-V-5	2-1/2 X 6	78.23
DD-8134K	BB8134	P-V-5	3 X 5	58.91
DD-8169K	BB8169	P-V-5	2 X 4	45.06
DD-8185K		P-V-5	2 X 5	48.73
DD-8206K		P-V-5	3 X 6	74.23
DD-8235K		P-U-5	3 X 5	63.58
DD-HA 2557	AB12308	N-OB-3	1-1/8 X 2-1/2	6.79
DD-HA 2561	AB12225	P-OB-3	1-1/8 X 2-1/2	16.13
DD-HA 2629	PI100-20	I-OB-3	1-1/2 X 3	13.17
DD-HA 2630	PI100-21	I-U-5	1-1/2 X 3-1/2	26.86
DD-HA 2632		I-U-4,12	4 X 4-1/2	53.93
DD-HA 2633		I-U-1	3" ROD	12.51
DD-HA 2634	PI100-94, CB10006	I-OB-3	1-1/2 X 2-1/2	11.78
DD-HA 2895	AB13978	I-OB-3	1-1/2 X 2-1/2	13.67
DD-HA 3300	BB8379-1, BB8748-1, BB8281-1	I-V-5	2 X 4	41.89
DD-HA 3301	BB6888, BB8281-1	I-N-4	2-1/2 X 3-1/2	15.22
DD-HA 3302	BB8133-1	I-V-5	2-1/2 X 6	68.12
DD-HA 3303	BB8374-1, BB8185-1	I-V-5	2 X 5	54.54
DD-HA 3304	BB8134-1	I-V-5	3 X 5	58.22
DD-HA 3527	AB19461, AB19462CH.	I-V-9	3 X 6	76.90
DD-HA 3541	AB19775TH	I-V-5,12	2 X 5	66.12
DD-HA 3542	AB19774TH	I-V-5,12	2 X 4	58.48
DD-HA 3557	AB19602TH	I-N-4	2-1/2 X 3-1/2	20.76
DD-HA 3558	AB19601TH	I-V-5	3 X 5	58.38
DD-HA 3559	AB19600TH	I-V-5	2-1/2 X 6	86.27
DD-HA 3562	AB19869TH	I-V-5	2 X 4	46.81
DD-HA 3563	AB19890TH	I-V-5	2 X 5	54.62
DD-HA 3775		I-U-5	1-3/4 X 4	37.53
DD-HA 3799		I-U-13	2-1/2 X 3-1/2	29.98

Kit Number	Cylinder Number	Code (Pg. xiv)	RodXBore Size	List Price
DD-HA 3809		I-U-10,12	2 X 4	\$ 62.47
DD-HA 3868		I-U-10,12	2-1/2 X 4-1/2	85.11
DD-HA 3869		I-U-4	1-1/4 X 2	16.81
DD-HA 4166		I-U-10,12	2-1/2 X 5	63.87
DD-HA 4263		I-U-1	3-1/2 X 4	31.45
DD-HA 4264		I-U-10	3 X 5	36.92
DD-HA 4265		I-U-10	2-1/2 X 6	42.63
DD-HA 4380		I-U-12	2 X 4	47.63
DD-HA 4387		I-U-10	2-1/2 X 4	77.78
DD-HA 4444		I-U-10	2" X 4"	54.59
DD-HYO 49	O-Ring Kit for 6 Stage Hyco 4"-9"			17.57
DD-PK00107	DB07208, AB26635	P-V-5	2-1/2 X 6	64.36

DENSMORE

Kit Number	Code (Pg. xiv)	Rod X Bore Size	List Price
DN501220767A	I-U-3	1-1/4 X 5	\$ 36.01
DN6012272438	I-U-3	1-1/4 X 6	46.82
DN6014304312	I-U-3	1-1/2 X 6	36.46
DN6020304312	I-U-3	2 X 6	44.16
DN7014273372	I-U-3	1-1/2 X 7	56.95
DN7020303312	I-U-3	2 X 7	54.19

DOOSAN INFRACORE

Kit Number	Code (Pg. xiv)	Rod X Bore Size	List Price
DI-2440-9234KT	P-UB-14	85 X 120 mm	\$ 101.54
DI-2440-9236KT	P-UB-14	95 X 135 mm	102.83
DI-2440-9339KT	P-UB-14	80 X 120 mm	99.29
DI-440-00355AKT	P-UB-14	85 X 120 mm	100.74

DRILTECH

Kit Number	Code (Pg. xiv)	Rod X Bore Size	List Price
DT-1027-088	I-V-9	2-1/2 X 5	\$ 109.08
DT-1029-085	I-V-9	3 X 4-1/2	132.42
DT-12471-058	I-V-9	3-3/4 X 5	275.64
DT-1974-065	I-V-9	3 X 5	177.06
DT-3130-077	I-V-9	3 X 5	113.27

DYNAHOE

Kit Number	Code (Pg. xiv)	Rod X Bore Size	List Price
DH-116613	P-U-10	3 X 6	\$ 70.56
DH-116840	P-U-10	2-1/2 X 4	46.07

EATON-YALE, TIMBERJACK

Kit Number	Code (Pg. xiv)	Rod X Bore Size	List Price
EY-2106793	P-U-10	1-1/2 X 3	\$ 34.79
EY-6955800	I-U-10	2 X 3-1/2	43.22
EY-6955804	I-U-10	2-1/4 X 5	67.74
EY-6955805	I-U-10	2-1/2 X 5-1/2	69.81

EDBRO

Kit Number	Bore	Lip Hgt.	Thick-ness	Hole Size	List Price
9200-062ED	2	7/8	7/32	5/8	\$ 11.72
9262-087ED	2-5/8	7/8	7/32	7/8	21.59
9325-100ED	3-1/4	7/8	7/32	1	23.27
9387-112ED	3-7/8	7/8	7/32	1-1/8	26.60
9475-125ED	4-3/4	7/8	7/32	1-1/4	32.00
9575-150ED	5-3/4	7/8	7/32	1-1/2	37.98

EFFER CRANES

Kit Number	Code (Pg. xiv)	Rod X Bore Size	List Price
EF-2160990	I-U-15	100 X 140 mm	\$ 74.49
EF-2166980	I-U-15	35 X 50 mm	38.75
EF-2261990	I-U-15	130 X 220 mm	130.60
EF-2565990	I-U-15	70 X 90 mm	47.83
EF-2663990	I-U-15	65, 125, X 95, 150 mm	119.73
EF-2761990	I-U-15	110 X 150 mm	100.13
EF-3461990	I-U-15	90 X 130 mm	74.05
EF-3760990	I-U-15	120 X 170 mm	93.43
EF-3761990	I-U-15	90 X 130 mm	74.05
EF-3764990	N-N-15	130 mm PISTON	67.82
EF-3861990	I-U-15	65 X 100 mm	54.68
EF-4464990	N-N-15	130 mm PISTON	117.64
EF-4469990	I-U-15	35, 75, 120 X 55, 90, 135 mm	150.47
EF-8086500	N-N-15	95, 150 PISTONS	120.79
EF-8087300	N-N-15	130 mm PISTON	37.27

ENERGY

Kit Number	Code (Pg. xiv)	Rod X Bore Size	List Price
EN-12621X	I-U-3	2 X 4	\$ 40.82
EN-A2430	P-OB-3	1-1/8 X 2	8.27
EN-A2859	P-U-3	1-1/4 X 3	15.04
EN-A7564	P-U-3	1-1/2 X 4	21.67

ESCO

Kit Number	Code (Pg. xiv)	Rod X Bore Size	List Price
ES-402965	O-Rings		\$ 4.15
ES-402968	O-Rings/Back-Ups		8.07
ES-402970	O-Rings/Back-Ups		3.88
ES-4046426	I-U-5,10	2-1/2 X 5	97.33
ES-4049054	TRW Motor Kit		67.39
ES-4050756	I-U-10	2-1/4 X 4	33.32
ES-4095570	I-U-10	2-1/4 X 4	33.32
ES-420885	I-U-5	1-1/2 X 3-1/2	21.65
ES-421446	I, P-U-5	2 X 4	26.52
ES-421461	I, P-U-5	2 X 5	69.50
ES-421479	P-U-5	2 X 6	76.18
ES-422204	I, P-U-5	2 X 3-1/2	45.81
ES-434043	I-U-10	2-1/2 X 5	31.99
ES-434837	I-U-4	2-1/2 X 4	37.71
ES-435261	I-U-5	1-1/2 X 3-1/2 Boom Cyl.	39.84
ES-435398	I-U-10	2 X 4	25.15
ES-435430	I-U-10	2 X 4	30.04
ES-435686	I-U-5,10	2-1/2 X 5	97.37
ES-435942	I-U-10	2-1/4 X 4	31.90

EUCLID TRUCKS

Kit Number	Description	List Price
EUC-12977806	4, 6.5, 8.5	\$ 466.28
EUC-4046574	6.25, 7, 8.25, 9, 10.5, 11	872.38
EUC-603323	4, 6, 8	392.83
EUC-R22HOIST	4, 6.5, 8.5	164.23
EUC-R50HOIST	3, 6, 8	163.48